

Size-resolved physico-chemical characterization of diesel exhaust particles and efficiency of exhaust aftertreatment

Zeraati Rezaei, Soheil; Alam, Salim; Xu, Hongming; Beddows, David; Harrison, Roy

DOI:

[10.1016/j.atmosenv.2019.117021](https://doi.org/10.1016/j.atmosenv.2019.117021)

License:

Creative Commons: Attribution-NonCommercial-NoDerivs (CC BY-NC-ND)

Document Version

Peer reviewed version

Citation for published version (Harvard):

Zeraati Rezaei, S, Alam, S, Xu, H, Beddows, D & Harrison, R 2020, 'Size-resolved physico-chemical characterization of diesel exhaust particles and efficiency of exhaust aftertreatment', *Atmospheric Environment*, vol. 222, 117021. <https://doi.org/10.1016/j.atmosenv.2019.117021>

[Link to publication on Research at Birmingham portal](#)

Publisher Rights Statement:

Checked for eligibility: 06/11/2019.

Published by Elsevier in Atmospheric Environment: <https://doi.org/10.1016/j.atmosenv.2019.117021>

General rights

Unless a licence is specified above, all rights (including copyright and moral rights) in this document are retained by the authors and/or the copyright holders. The express permission of the copyright holder must be obtained for any use of this material other than for purposes permitted by law.

- Users may freely distribute the URL that is used to identify this publication.
- Users may download and/or print one copy of the publication from the University of Birmingham research portal for the purpose of private study or non-commercial research.
- User may use extracts from the document in line with the concept of 'fair dealing' under the Copyright, Designs and Patents Act 1988 (?)
- Users may not further distribute the material nor use it for the purposes of commercial gain.

Where a licence is displayed above, please note the terms and conditions of the licence govern your use of this document.

When citing, please reference the published version.

Take down policy

While the University of Birmingham exercises care and attention in making items available there are rare occasions when an item has been uploaded in error or has been deemed to be commercially or otherwise sensitive.

If you believe that this is the case for this document, please contact UBIRA@lists.bham.ac.uk providing details and we will remove access to the work immediately and investigate.

1
2
3 **Size-Resolved Physico-Chemical**
4 **Characterization of Diesel Exhaust Particles and**
5 **Efficiency of Exhaust Aftertreatment**
6

7 **Soheil Zeraati-Rezaei¹, Mohammed S. Alam²,**
8 **Hongming Xu¹, David C. Beddows^{2,3}**
9 **and Roy M. Harrison^{2,3*†}**

10
11
12 **¹ Department of Mechanical Engineering**
13 **School of Engineering, University of Birmingham, Edgbaston**
14 **Birmingham, B15 2TT**
15 **United Kingdom**

16
17 **² School of Geography, Earth & Environmental Sciences**
18 **University of Birmingham, Edgbaston, Birmingham, B15 2TT**
19 **United Kingdom**

20
21 **³ National Centre for Atmospheric Science**
22 **School of Geography, Earth and Environmental Sciences**
23 **University of Birmingham**
24 **Edgbaston, Birmingham B15 2TT**
25 **United Kingdom**
26

* To whom correspondence should be addressed.
Tele: +44 121 414 3494; Fax: +44 121 414 3708; Email: r.m.harrison@bham.ac.uk

† Also at: Department of Environmental Sciences / Center of Excellence in Environmental Studies, King Abdulaziz University, PO Box 80203, Jeddah, 21589, Saudi Arabia

27 **HIGHLIGHTS**

- 28 • Particle emissions sampled from a light-duty diesel engine
- 29 • Size fractionated from <10 nm to >10 μm diameter and then chemically characterized
- 30 • Hydrocarbons peak at 100 nm and are alkanes (main), cyclics, bicyclics, aromatics
- 31 • Hydrocarbons removed by >90% by DOC+DPF while oxygenates formed within DOC+DPF
- 32 • High concentration of <2.5 nm particles measured and efficiently removed by DOC+DPF
- 33

34 **ABSTRACT**

35 Knowledge of physico-chemical characteristics of particle emissions from combustion engines is
36 essential for various modelling purposes and environmental analysis. It is of particular interest to
37 obtain emission factors of intermediate-volatility organic compounds (IVOC) and semi-volatile
38 organic compounds (SVOC) which have not been comprehensively reported in the literature due to
39 the limitations of characterisation methods. In the current study, a multi-stage Nano impactor and
40 the two-dimensional gas chromatography (GC×GC) mass spectrometry (MS) technique were used
41 to comprehensively characterise size fractionated particle phase emissions from a light-duty diesel
42 engine based on the particle size, compound groups and carbon number. The number size
43 distributions of particles between 1.2-1000 nm were also investigated. Exhaust gas samples were
44 taken before a diesel oxidation catalyst (DOC), after the DOC and after the DOC combined with a
45 catalysed diesel particulate filter (DPF). In samples taken before the DOC (engine-out), the total
46 particulate IVOC+SVOC (I+SVOC) emission factor was approximately 105 milligrams per
47 kilogram of fuel consumed (which was ~49% of the total particle mass) and the peak concentration
48 of different classes of I+SVOC was found in the particle size bins close to 100 nm where most of
49 the total particle mass was found. Alkanes, with maximum abundance at C₂₄, were the most
50 dominant class of I+SVOC in samples taken before and after the aftertreatment devices. Total
51 particulate I+SVOC emissions were removed with ~75% efficiency using the DOC and by ~92%
52 using the DOC+DPF. Alkanes, cycloalkanes, bicyclics and monoaromatics were all removed by
53 >90% using the DOC+DPF; however, oxygenates were removed by only ~76% presumably due to
54 the oxidation of different species within the aftertreatment system and reappearance as oxygenates.
55 A high concentration of particles was measured in the sub-2.5 nm range. These particles were
56 efficiently removed by the DOC+DPF due to both the loss of I+SVOC and physical filtration.

57

58 **Key words:** Diesel engine; Particulate matter; Particle size magnifier; SVOC; DOC; DPF;

59

60 1. INTRODUCTION

61 Adverse environmental and health effects of primary and secondary emissions originated from
62 combustion engines have motivated research into their properties and possible abatement
63 mechanisms. Conventionally, diesel compression ignition engines are more energy efficient (emit
64 less CO₂) compared to their gasoline spark ignition engine counterparts (Heywood, 1988; Stone,
65 1999). This has resulted in widespread utilisation of diesel engines for heavy-duty and light-duty
66 applications; currently in Europe approximately half of the road vehicles are diesel fuelled (IEA,
67 2016; ICCT, 2018), even though there has been a recent decline in the number of newly registered
68 diesel vehicles (ICCT, 2018; Department for Transport UK, 2018). However, conventional diesel
69 vehicles with no or malfunctioning aftertreatment systems can emit higher levels of oxides of
70 nitrogen (NO_x) and particulate matter compared to gasoline vehicles. There still can be some
71 challenges for the modern diesel aftertreatment systems to operate efficiently under certain
72 operating conditions. For instance, NO_x abatement in the fuel-lean exhaust of diesel vehicles can be
73 problematic at low exhaust temperatures (Majewski and Khair, 2006), and the impact of active
74 regeneration of a diesel particulate filter (DPF) on deteriorating engine fuel economy and increasing
75 vehicle emissions (including particulate matter itself) can be considerable (Majewski and Khair,
76 2006; Gordon et al., 2014).

77

78 Emissions of particles, the pollutant with the greatest public health impact (IEA, 2016), contain
79 mostly elemental carbon and organic compounds (Eastwood, 2008; Kittelson, 1998). The organic
80 fraction is complex as it derives from thousands of different hydrocarbons (HC) in unburned fuel
81 and engine lubricating oil and contains compounds resulting from partial combustion and pyrolysis
82 (Funkenbusch et al., 1979; Black and High, 1979; Alam et al., 2016; Zeraati-Rezaei et al., 2016;
83 Laurence et al., 1996). Typical European diesel fuels and engine lubricating oils are mainly
84 comprised of intermediate–volatility organic compounds (IVOC) and semi-volatile organic
85 compounds (SVOC) in the range of C₁₁ to C₃₀ (fuel) and C₁₆ to C₃₃ (oil) (Alam et al., 2018). Gas-

86 particle partitioning of the IVOC+SVOC (I+SVOC), with different volatilities and vapour
87 pressures, is highly active under the exhaust conditions (Alam et al., 2016; Donahue et al., 2006),
88 with at least one percent of the SVOC mass being found in either the condensed or gas phase
89 (Donahue et al., 2006). Their vapour pressure in the atmosphere is between 10^{-11} and 10^{-5} atm and
90 compounds in the exhaust of on-road diesel vehicles can contribute to the formation of secondary
91 organic aerosol (SOA) (Gordon et al., 2014; Zhao et al., 2015; Drozd et al., 2019). This highlights
92 the importance of knowing their detailed composition and concentration within the engine exhaust.

93

94 In this paper, the terms primary emissions and primary organic aerosol (POA) refer to pollutants
95 which exit the tailpipe, or are produced by processing in ambient air within a few seconds of
96 emission, such as the particles formed by nucleation of hot vapours as emissions dilute in roadside
97 air (Charron and Harrison, 2003). This differentiates them from secondary pollutants which form
98 from chemical reactions in the atmosphere on a longer timescale.

99

100 Studies, such as those by Huang et al. (2015) and Sakurai et al. (2003), have shown that the organic
101 fraction of particles is composed of compounds such as normal and branched alkanes, alkyl-
102 cycloalkanes, various aromatics and polycyclic aromatic hydrocarbons (PAH). However, few
103 studies have addressed SVOC with large carbon numbers ($C > 15$) in a detailed quantitative manner
104 since they are largely unresolved by conventional gas chromatography (GC) techniques and create
105 an unresolved complex mixture (UCM) in the chromatogram (Alam et al., 2016). Zhao et al. (2015)
106 claimed that on average more than 90% of compounds with approximately similar effective
107 saturation concentrations to those of C_{12} to C_{22} n-alkanes (i.e. between 10^3 and $10^6 \mu\text{g}/\text{m}^3$) appeared
108 as a UCM in conventional GC mass spectrometry (MS) techniques. However, using a more
109 comprehensive technique, such as two-dimensional GC (GC \times GC), helps to overcome this issue.
110 Alam et al. (2018) conducted a comprehensive study on diesel I+SVOC emissions using GC \times GC

111 time of flight (ToF) MS and were able to characterise each major I+SVOC class according to the
112 carbon number.

113 Gordon et al. (2014) conducted environmental chamber experiments to investigate SOA formation
114 from the diluted exhaust of medium- and heavy-duty diesel vehicles (the minimum engine
115 displacement volume was 5.9 L). They reported that knowledge of the uncharacterised less volatile
116 species in the UCM (~30% of the non-methane organic gas emissions) is necessary to better
117 understand SOA formation. Characterising these species can also lead to more accurate emission
118 factors. Total POA emission factors of below 100 mg/kg_f (milligrams per kilogram of fuel
119 consumed) were reported for the vehicles with no exhaust aftertreatment. These emission factors
120 were calculated under the assumption that all carbon in the fuel is converted to CO₂ (Gordon et al.,
121 2014). Actual measurements of engine fuel consumption can be helpful in improving the accuracy
122 of normalising the emission concentrations.

123

124 Some studies have shown that I+SVOC emission factors are strongly influenced by the exhaust
125 aftertreatment technology installed on the vehicle (Gordon et al., 2014; Zhao et al., 2015; Liu et al.,
126 2018; May et al., 2013). Liu et al. (2018) reported that the soluble organic fraction of particle
127 emissions from a large (8.9 L) non-road diesel engine was decreased by >80% when using a diesel
128 oxidation catalyst (DOC) in combination with a selective catalytic reduction system (SCR) and a
129 DPF. They suggested that a large fraction of SVOC is possibly in the gas phase under exhaust
130 conditions and is influenced by the DOC. Gordon et al. (2014) found that primary particle
131 emissions and SOA formation in the diluted exhaust of medium-heavy duty diesel vehicles
132 equipped with a catalysed DPF were very small under normal operation. However, during active
133 DPF regeneration, significant amounts of primary particles and SOA formation were measured.
134 SOA concentrations in the diluted exhaust of some vehicles with no DPF were more than two times
135 that of POA. Studies on light-duty diesel vehicles are very limited; May et al. (2013) recommended

136 investigating the volatility distribution of I+SVOC emissions from the light-duty diesel vehicles
137 widespread in Europe.

138

139 The majority of POA emissions from diesel vehicles are believed to be semi-volatile (May et al.,
140 2013); therefore, they are likely to shrink in size as a result of evaporation in the atmosphere due to
141 high dilution and long residence time (Robinson et al., 2007; Dall’Osto et al., 2011). It has been
142 shown that atmospheric-like dilution of the exhaust of diesel vehicles with no DPF causes one-half
143 to two-thirds of the POA to evaporate (May et al., 2013). However, the composition and
144 concentration of I+SVOC in each size class of engine exhaust particles have not previously been
145 reported comprehensively in the literature. Size-resolved chemical composition data can be
146 particularly useful and essential for:

- 147 • determining gas transfer effects on the atmospheric evolution of emitted engine particles on
148 different scales (for example in the study conducted by Nikolova et al. (2018) on the
149 neighbourhood scale;
- 150 • understanding and modelling of particle evolution within the vehicle exhaust system, designing
151 and modelling of oxidative and reductive catalysts as well as particulate filters.

152

153 “Another topic that has not been clearly covered in the available literature, is the study of very small
154 particles with diameters <3 nm emitted from modern light-duty engines. Recently, these particles
155 have been shown to be a major fraction of the total particle emissions measured in the atmosphere
156 (Hietikko et al., 2018) which are sourced from road transportation (including both heavy-duty and
157 passenger vehicles) and those emitted from a heavy-duty engine during engine laboratory
158 experiments – emission factors as high as $4.3 \times 10^{15} \text{ (kg}_{\text{fuel}})^{-1}$ were measured (Rönkkö et al., 2017).
159 Järvinen et al. (2019) used a particle size magnifier (PSM) and investigated in-traffic emissions
160 from city buses (including Euro VI compliant buses). They found that the studied buses can be
161 sources of large concentrations of particles in the diameter range of 1.3-3 nm, even using

162 aftertreatment system, depending on the driving conditions. These very small particles emitted from
163 different engines are believed to have both volatile and non-volatile constituents. Alanen et al.
164 (2015) studied the formation and physical properties of the particle emissions from a natural gas
165 engine including study of particles <3 nm with a PSM. They suggested that particles did not
166 evaporate completely even at 265 °C and have non-volatile cores, although it should be mentioned
167 that diesel engine particle emissions are very different from natural gas engine emissions. Even in
168 less recent studies, the presence of non-volatile cores in the sub-3 nm particles was highlighted.
169 Filippo and Maricq (2008) investigated the volatility of particle emissions larger than 2 nm in the
170 exhaust of light-duty vehicles and reported that the nucleation mode particles remain non-volatile to
171 >400 °C indicative of solid cores. The sources of these very small particles with presumably a solid
172 core are assumed to be in high temperature regions inside or in the vicinity of the combustion
173 chamber due to their electrical charge (Alanen et al., 2015; Sgro et al., 2012; Filippo and Maricq,
174 2008). It is important to investigate sub-3 nm particles emitted from modern light-duty diesel
175 engines and obtain their emission factors as the picture is not clear for the fleet using these
176 engines.”

177

178 In the current paper, for the first time, size-resolved particle phase I+SVOC emission factors
179 (concentrations normalised to the actual engine fuel consumption) for a light-duty diesel engine are
180 comprehensively reported based on the compound type and carbon number using a multi-stage
181 Nano impactor and GC×GC-ToF-MS technique. Furthermore, emission factors for CO, total HC
182 (THC), NO, NO₂, NO_x, CO₂, particle mass and number are presented. Particle size distributions are
183 characterised also in the sub-2.5 nm range using a PSM coupled with a condensation particle
184 counter. The link between particle size distribution and presence of I+SVOC in each particle size
185 bin is addressed. Furthermore, the individual effects of a DOC and a catalysed DPF on
186 characteristics of gaseous and particle (including I+SVOC and sub-2.5 nm) emissions are
187 investigated. Although engine and aftertreatment designs as well as fuel and lubricating oil

188 formulations are different around the world, presenting the results before and after these
189 aftertreatment devices can help elucidate situations where there are no or limited exhaust
190 aftertreatment systems installed in the vehicle.

191

192

193 **2. EXPERIMENTAL SETUP**

194 Experiments were conducted on a 2.2 L, 4-cylinder in-line diesel compression ignition (CI) engine
195 equipped with a common rail direct-injection (DI) system and a variable-nozzle-turbine (VNT)
196 turbocharger. This is a light-duty production engine, as found in the market designed for vehicles
197 registered after 2011 (Euro 5), without any major changes to its original settings. Main
198 specifications of the engine are listed in Table 1. The schematic of the engine dynamometer test cell
199 is illustrated in Figure 1. The open engine control unit (Open-ECU) allows full control over the
200 engine operating parameters.

201

202 Experiments were performed at the low engine load of 1.4 bar brake mean effective pressure
203 (BMEP) and speed of 1800 revolutions per minute (RPM). This engine condition was selected from
204 a dynamometer testing matrix used for assessing the engine performance and fuel economy in a
205 target vehicle new European driving cycle (NEDC) test. Furthermore, I+SVOC characterisation at
206 this condition is believed to be important as the formation rate of SOA from I+SVOC has shown to
207 be higher in the diluted exhaust of engines operating at lower loads (Gordon et al., 2014). A
208 pilot+main fuel injection strategy with an injection pressure of 600 bar was used and exhaust gas
209 recirculation (EGR) was fixed at 33%. Experiments were conducted under the steady state engine
210 condition – the engine was fully warmed-up and thermally stable.

211

212 The engine was equipped with a newly-fitted DOC+DPF exhaust aftertreatment system; the DOC
213 was located upstream of the DPF. The honeycomb of the DOC has a circular profile with a diameter

214 of 144 mm and length of 96 mm and has 20×20 (400) cells per square inch. The DPF brick is 157
215 mm in length and has an oval cross section (188 mm and 153 mm in cross sectional profile). This
216 DPF is believed to be catalysed as it oxidised unconverted exhaust CO and HC during the
217 experiments. During these experiments, exhaust back pressure did not exceed the level at which it is
218 required to use the active regeneration strategies. Active regeneration of the DPF is known to
219 significantly increase primary particulate matter emissions and SOA formation (Gordon et al.,
220 2014). However, it is necessary to identify the contribution of the active regeneration emissions to
221 the total light-duty vehicle emissions; but this was out of the scope of the current study. Gordon et
222 al. (2014) estimated this to be negligible for medium- and heavy-duty diesel vehicles by considering
223 the regeneration frequency – total particulate matter filtration efficiency was reduced by less than
224 2%.

225

226 Ultra-low sulphur diesel fuel that complied with the EN590 specifications was used for these
227 experiments – cetane number was 52.5 and sulphur content was approximately 8 mg/kg. This diesel
228 fuel has been comprehensively analysed previously and results showed that it includes n-alkanes,
229 branched alkanes (mono-, di-, tri-, tetra- and penta-methyl), n-alkyl cycloalkanes, branched
230 monocyclic alkanes, C₁–C₁₂ substituted bicyclic alkanes, C₁–C₄ substituted tetralins and indanes,
231 C₃–C₁₂ substituted monocyclic aromatics, C₁–C₃ substituted biphenyls/acenaphthenes, C₁–C₄
232 substituted bicyclic aromatics, C₁–C₂ substituted fluorenes, C₁–C₂ substituted
233 phenanthrene/anthracenes and unsubstituted PAH (Alam et al., 2018). The majority of the
234 compounds are aliphatic, and aromatic mass content is approximately 10% (Alam et al., 2018).
235 Engine fuel mass consumption was measured by an AVL 733s dynamic fuel meter equipped with
236 an AVL 752-60 fuel cooler. Fuel temperature in the feed and return lines was monitored and
237 controlled to assure repeatable fuel consumption measurements. The fuel meter was calibrated
238 frequently using a built-in function. Fuel consumption measurement error by the AVL 733s is from
239 0.12% to 0.2% of the measured values depending on the fuel consumption.

240

241 The utilised SAE 5W30 part-synthetic lubricating oil is representative of the standardised engine
242 lubricating oils available in the market complying with the ACEA A1/B1 and API SN/CF oil
243 industry standards and the WSS-M2C913-B vehicle manufacturer specifications. Characterisation
244 results of the typical engine lubricating oils have been reported elsewhere (Alam et al., 2018; Liang
245 et al., 2018). Briefly, a typical SAE 5W30 lubricating oil mainly contains C₁₆–C₃₃ straight and
246 branched chain alkanes, C₁₆–C₃₃ monocyclic alkanes, C₁₇–C₃₃ bicyclic alkanes, C₁₇–C₃₃ tricyclic
247 alkanes and C₁₆–C₃₃ monocyclic aromatics (Alam et al., 2018).

248

249 Calibrated K-type thermocouples (RS Company), with mostly 3 mm probe diameter, were used to
250 measure temperatures at different locations of the engine and test cell. Pressure data were measured
251 at different locations using Variohm EuroSensor EPT 3100 pressure transducers (max 2 bar). These
252 pressure transducers were calibrated frequently by using a Druck DPI 601 portable pressure
253 indicator/calibrator.

254

255 Regulated gaseous emissions were repeatedly measured by a calibrated Horiba MEXA-7100-DEGR
256 exhaust gas analyser directly from the exhaust pipe at different locations. Each measurement is the
257 average of 180 samples (each sample takes 1 s). Horiba MEXA-7100-DEGR uses the
258 chemiluminescence detection (CLD) technique for NO_x and NO, dry non-dispersive Infra-Red
259 (NDIR) technique for CO and CO₂, hot-wet (uncondensed) flame ionisation detector (FID)
260 technique for THC and magneto-pneumatic (MPA) technique to measure oxygen (O₂).
261 Measurement linearity related to using analysers included in the Horiba MEXA-7100-DEGR are all
262 $\leq \pm 1\%$ of full-scale output. Engine exhaust gas was delivered to the analyser by means of the
263 heated sampling line with temperature maintained at $191 \pm 3^\circ\text{C}$. The method for derivation of the
264 emission factors from measurements conducted by this instrument is provided in Supplementary
265 Information, section A1.

266

267 A calibrated Cambustion DMS500 MKII fast particulate analyser was used to measure exhaust
268 particle size distributions in the size range of approximately 5 nm to 1000 nm. It separates different
269 sizes of particles based on their aerodynamic drag and charge while migrating in an electric field
270 (Cambustion, 2015a). The integrated two-stage dilution system of the utilised DMS500 uses hot
271 compressed air for the first diluter (dilutes at low dilution ratios) and cleaned exhaust gas (by a
272 carbon high-efficiency-particulate-air (HEPA) filter) for the second diluter (dilutes at high dilution
273 ratios using a rotating disk). The first dilution ratio was fixed at 1:5 in the current study. The
274 secondary dilution ratio is normally required to be adjusted to ensure concentrations are within the
275 detectable range. In the current study, the secondary dilution ratio was fixed at approximately 1:100
276 for the measurements of size distributions before and after the DOC, while for after the DPF
277 measurements, a secondary dilution ratio of 1:1 was used as the particle concentrations were very
278 low. The dilution ratio is calculated automatically using the built-in software and all the results are
279 corrected for the dilution ratio at each test point. Use of a carbon HEPA filter for the secondary
280 diluter, rather than a normal HEPA filter, was designed to strip the majority of the volatile species
281 for the dilution of sampled exhaust gas. A software package utilising a Bayesian statistical
282 algorithm (Cambustion, 2015b) provided by Cambustion was used to separate the nucleation and
283 accumulation modes based on the concentration, mean size and width (geometric standard
284 deviation) of the distribution. In this way, the total concentration of each mode is calculated
285 separately while considering the number of classes per decade of the measurable size range
286 (Cambustion, 2015a). Moreover, total mass can be calculated more accurately, as explained in
287 Cambustion (2015c), since the characteristics (e.g. effective density and physical geometry) of
288 particles of each mode are different. The electrometers of the DMS500 were zeroed before the start
289 of each data point collection using the built-in Autozero function to ensure minimum offset noise
290 effect on the results. The data were averaged over 60 s for a single measurement while each data
291 point presented in this paper is the average of multiple measurements. The standard deviation of the

292 data was carefully monitored when repeating the experiments to ensure small deviations from the
293 mean value. As an example, the standard deviation of the total particle number concentration was
294 up to 2 orders of magnitude smaller than the mean value of the data points. The method for
295 derivation of the emission factors from measurements performed by the DMS500 is provided in
296 Supplementary Information, section A2. In this paper, the results obtained by using the DMS
297 sampling system are presented in a grey box.

298

299 An in-house engine exhaust dilution system (Figure 2) was used for diluting the hot exhaust gas
300 before introducing it to the Nano-Moudi and Particle Size Magnifier systems which are described
301 later in this section. This dilution system incorporates a modified TSI model 3302A diluter. The
302 diluter was modified to use compressed air passed through a high flow rate moisture trap and two
303 HEPA filters. The undiluted hot exhaust sample, delivered *via* a heated line maintained at $191\pm 3^{\circ}\text{C}$,
304 mixes with a filtered external airstream at ambient temperature. The sampling lines used in the
305 exhaust dilution and sample collection system are conducting-tubing to minimise any particle loss.
306 Dilution ratio was kept at approximately $1:50\pm 5$ confirmed by measurements of NO_x before and
307 after the dilution system. The temperature at the sampling points (after the diluter) was $25\pm 5^{\circ}\text{C}$. It
308 should be highlighted that this in-house dilution system is different from the integrated dilution
309 system within the DMS500 (described earlier).

310

311 An A10 Particle Size Magnifier (PSM) from Airmodus combined with a TSI 3775 condensation
312 particle counter (CPC) was used to measure particles with mobility diameter between 1.2 nm to 2.5
313 nm. The PSM grows nanoparticles to the sizes that can be further grown and detected by the CPC
314 (Airmodus, 2017). The condensing liquid used in the PSM was diethylene glycol (Airmodus, 2013)
315 while it was n-butanol in the CPC. The scanning measurement mode of the PSM was used for these
316 experiments which continuously adjusts the cut-off diameter of the PSM (Airmodus, 2013;
317 Kangasluoma et al., 2013). Each sampling event lasted for 30 minutes including 6 scans (each for 5

318 minutes). The PSM has been calibrated by Airmodus using ammonium sulphate particles produced
319 in a tube furnace and size selected with a high resolution differential mobility analyser (DMA)
320 (Airmodus, 2013). The method for derivation of the emission factors from measurements done by
321 the PSM system is provided in Supplementary Information, section A3.

322

323 A Nano-micro orifice uniform deposit impactor (Nano-Moudi) 125 instrument from MSP Copley
324 Scientific was utilised for collecting exhaust particles at different sizes for size-resolved
325 characterisation of the I+SVOC. In a Nano-Moudi (an inertial impactor), particles are collected on
326 different stages based on the Stokes number which is a function of particle density, slip correction,
327 particle diameter, air viscosity, nozzle diameter and volumetric flow rate through the nozzle.
328 Thirteen stages of the Nano-Moudi from S1 to S13 with nominal 50% cut-points of 10000, 5600,
329 3200, 1800, 1000, 560, 320, 180, 100, 56, 32, 18 and 10 nm, respectively, were used in this study.
330 In this paper, when discussing Nano-Moudi results of >100 nm, for example, it means particles in
331 the diameter range of 100 nm to 180 nm (the cut-point of the previous stage); this does not apply to
332 S1 as there is no stage before it. Volumetric flow rate through the Nano-Moudi was 9 litres per
333 minute and samples were collected for 30 minutes using polypropylene backed PTFE 47 mm filters
334 from Whatman.

335

336 I+SVOC on each stage of the Nano-Moudi were characterised using two-dimensional gas
337 chromatography time-of-flight mass spectrometry (GC×GC-ToF-MS). Details of this GC×GC-ToF-
338 MS characterisation method are provided by Alam et al. (2019). Briefly, the PTFE filters were
339 spiked with internal standards and subsequently were immersed in dichloromethane (DCM) and
340 then the mixture was ultrasonicated for 20 minutes at 20°C. The extract was concentrated to 50 µL
341 under a gentle flow of nitrogen. Then this sample was analysed by means of a two-column GC
342 7890A from Agilent Technologies equipped with a cryogenic modulator (Zoex ZX2). The GC×GC
343 was connected to a Bench-ToF-Select from Markes International. The scan speed and ionisation

344 energy were set at 50 Hz and 70 eV, respectively. Details of the temperature ramp settings are
345 provided by Alam et al. (2016). All the analysis include consideration of internal standards and
346 subtraction of the I+SVOC content found on the blank filters. Solvent blank injections and blank
347 filter extractions both did not show any peaks in the chromatography and so all compounds are
348 below the detection limit, indicating no instrument artefacts (please refer to Alam et al. (2019) for
349 more information). Data were processed and post-processed *via* GC Image v2.5 from Zoex
350 Corporation. Computer language for identifying chemical (CLIC) was used to characterise different
351 classes of I+SVOC within each sample. Using this technique in earlier work (Alam et al., 2018), we
352 reported mass closures of approximately 90% and 75% for diesel fuel and engine lubricating oil
353 samples and around 85% and 75% of the total ion current were identified for gas and particle phase
354 diesel engine I+SVOC emissions respectively. The uncertainty of this analysis method is
355 approximately 24% and more details are provided in Alam et al. (2108). Repeatability of the
356 I+SVOC volatility profile and concentration has been ensured during different testing campaigns
357 and also by comparing Nano-Moudi results with those of single PTFE filters using the same engine
358 but at different times. In the current study, we found that C₁₃ to C₃₇ alkanes (including straight- and
359 branched-chain), C₁₄ to C₃₂ cycloalkanes, C₁₆ to C₂₃ bicyclic alkanes, C₁₃ to C₂₆ monocyclic
360 aromatics and C₉ to C₂₇ oxygenated compounds (including ketones, aldehydes and furanones) are
361 the most abundant I+SVOC classes in the diesel exhaust particle samples and therefore are the
362 focus of this paper. The method for derivation of the I+SVOC emission factors is provided in
363 Supplementary Information, section A4.

364

365 **3. RESULTS AND DISCUSSION**

366 **3.1 Regulated Gaseous Emissions and Particle Size Distribution**

367 **3.1.1 Gaseous emissions**

368 Gaseous emission factors and their reduction percentage (conversion or reduction efficiency
369 depending on the species) over the aftertreatment devices are listed in Table 2. Engine-out (before

370 DOC) emission factors for CO and THC at this low load engine condition were relatively high
371 because of lower combustion efficiency. However, their conversion efficiencies were high and they
372 were decreased at two separate stages – once over the DOC and once over the DPF. This is an
373 indication that the utilised DPF is catalyst coated. In addition, these results confirm that the DOC
374 and DPF were in an active state for converting HC, which is important for discussing I+SVOC
375 results later in this section. It is believed that the absence of NO₂ production was due to the fact that
376 the operating temperature was not high enough (was below 200°C) to initiate this process (Kim et
377 al., 2011). The conversion of NO₂ to NO is believed to be due to its decomposition and
378 consumption of its oxygen content by the available CO and HC on the catalyst active sites. There
379 was an overall reduction of NO_x due to conversion of NO to N₂ over the catalysts. Exhaust gas
380 temperature after the DOC, before entering the DPF, increased by approximately 23°C and this is
381 believed to be because of exothermic reactions within the DOC (e.g. combustion of CO and HC
382 which subsequently increased the CO₂ concentration).

383

384 **3.1.2 Particle emissions**

385 Effects of the DOC and DPF on the size distribution of particle emissions can be seen in Figure 3.
386 In this figure, particles with diameter between 1.2 and 2.5 nm were measured by the PSM system
387 and particles with diameter between 4.87 and 1000 nm were measured by the DMS system (refer to
388 the experimental setup section). Volume size distributions (Figure 3 (b)) were calculated under the
389 assumption that all particles have a completely spherical geometry – an assumption that may not be
390 completely correct for larger diesel exhaust particles, especially in the accumulation mode
391 (Kittelson, 1998).

392

393 PSM results showed a high concentration peak at approximately 1.5 nm in the samples taken both
394 before and after the DOC (Figure 3 (a)). The concentration was the highest for measurements before
395 the DOC, decreased after the DOC, and was negligible after the DOC+DPF. The possibility of

396 formation and/or growth of small particles in the exhaust dilution system is reduced when
397 concentrations of gaseous volatile and semi-volatile HC are decreased by using a DOC. For such
398 small particles, kinetic limitations to the loss of semi-volatile constituents are very small, and
399 therefore even constituents of quite low volatility can evaporate. Considering the results before and
400 after the DOC+DPF system, one can conclude that the sub-2.5 nm particle emissions from the
401 current diesel engine contain both volatile and non-volatile constituents. The non-volatile nuclei are
402 efficiently removed by the DPF as shown in Figure 3 as also reported by Filippo and Maricq (2008)
403 for light-duty diesel vehicles. The sources of these particles (which presumably include a solid core)
404 are assumed to be in high temperature regions inside or in the vicinity of the combustion chamber
405 due to their electrical charge (Filippo and Maricq, 2008; Alanen et al., 2015; Sgro et al., 2012).
406 Sulphur storage and release in the newly-fitted aftertreatment system (acting as a reservoir) is
407 another possibility (Herner et al., 2011; Kittelson et al., 2006). It has been reported that sulphur
408 storage and release mechanisms are more related to the DOC rather than the DPF of the
409 aftertreatment system (Swanson et al., 2009). Within a DOC or a catalysed DPF, engine out SO₂
410 can convert to SO₃. SO₃ can react with H₂O and form H₂SO₄ (sulphuric acid) which can nucleate
411 under the atmospheric conditions. Tiszenkel et al. (2019) conducted a preliminary study about the
412 effects of temperature on the nucleation and growth of sulphuric acid using the Tandem Aerosol
413 Nucleation and Growth Environment Tube (TANGENT). They used a PSM after the nucleation
414 tube of the TANGENT system and confirmed that at temperatures around 24°C, similar to the
415 temperature of the dilution point for the PSM results in the current study, clusters with a diameter of
416 1.65-1.70 nm were formed, hypothetically via a ternary process. This diameter, which is close to the
417 peak concentration diameters measured in the current study, did not change significantly as the
418 sulphuric acid concentration was increased. This finding can indicate a possible role of sulphuric
419 acid in forming sub-2.5 nm particles, although the exhaust gas mixture is very different to the
420 mixture that Tiszenkel et al. (2019) studied. However, in the current study, the sulphur content of
421 the ULSD fuel was very low (approximately 8 mg/kg), but the sulphur content of the engine

422 lubricating oil and its contribution to the emissions are unknown. It would be interesting to
423 investigate the sensitivity of size distribution and characteristics of these very small diesel exhaust
424 particles to the dilution conditions, e.g. dilution ratio and relative humidity as two important factors
425 (Shi and Harrison, 1999).

426

427 Bimodal particle size distributions, with both modes of nucleation and accumulation (the latter also
428 referred to as the soot mode), were detected in measurements by the DMS upstream and
429 downstream of the DOC (Figure 3(a)). Particle concentrations after the DPF appear to be negligible
430 – there was no sign of an enhanced nucleation mode concentration which has been reported by other
431 researchers for some engine operating conditions (Herner et al., 2011). Count median diameter
432 (CMD) of the nucleation mode particles was 19.3 and 17.6 nm upstream and downstream of the
433 DOC, respectively. CMD of accumulation mode particles upstream and downstream of the DOC
434 was 54.9 and 50.4 nm, respectively.

435

436 The DOC had a considerable effect in reducing the nucleation mode particles – mass decreased
437 from 0.0094 to 0.0032 g/kg_f. The nucleation mode comprises particles with a small non-volatile
438 core (ca 5 nm) and a major part condensed semi-volatile HC (Filippo and Maricq, 2008; Lähde et
439 al., 2009; Rönkkö et al., 2007). In the dilution system and in the presence of soot particles, semi-
440 volatile HC, which can also nucleate during dilution, can be adsorbed by the soot surface and
441 increase the size and mass of particle emissions. The DOC oxidises some of the gaseous HC and
442 therefore contributes to a reduction in nucleation mode particle number.

443

444 There was also a reduction of the accumulation mode particles in the DOC – mass decreased from
445 0.2063 to 0.1664 g/kg_f. The accumulation mode comprises a larger graphitic carbon core, with a
446 coating of condensed semi-volatile HC (Shi et al., 1999; Shi et al., 2000). Exothermic reactions
447 inside the DOC can increase the temperature near active sites and may facilitate oxidation of HC

448 already adsorbed on soot particles. However, the data in Figure 3 show little change in particle size
449 on passing through the DOC. These particles can also deposit on the top and to the monolith walls
450 of the DOC (Eastwood, 2008). These deposited particles cannot be catalytically converted and
451 therefore may only be oxidised under high temperature conditions. Therefore, the results suggests
452 both loss of particles in the DOC and particle shrinkage due to HC oxidation.

453

454 Figure 3(b) illustrates that the peak of volume size distribution was associated with particles with
455 diameter of 100 nm for measurements before the DOC. The majority of volume (and presumably
456 mass) of particles are present around this particle diameter. Particles measured by the PSM made
457 very little contribution to the total volume due to their small diameter.

458 **3.2 Particle Phase I+SVOC Composition and Size Distribution**

459 Table 3 shows the results for particle mass (using the DMS) and I+SVOC mass (using the Nano-
460 Moudi). In this table, nucleation mode (Nuc.) particle mass and accumulation mode (Acc.) particle
461 mass (calculated as described in the experimental setup section) were added to calculate the total
462 particle mass (PM). The DMS results after the DOC+DPF showed a very small number of particles
463 and therefore no peaks of nucleation and accumulation were detected using the log-normalisation
464 method. Total mass of each I+SVOC class (namely alkanes, cycloalkanes, bicyclic alkanes,
465 monocyclic aromatics and oxygenated compounds) were calculated by adding the data of Nano-
466 Moudi stages below 1000 nm, which is the maximum measurable diameter by the utilised DMS.
467 This was done in order to help elucidate the relation between total PM and total I+SVOC (addition
468 of all classes) and each I+SVOC class.

469

470 Total PM decreased by approximately 21%, comparing measurements before and after the DOC
471 and this was driven by the decrease of both nucleation and accumulation mode particles. Total
472 particle phase I+SVOC before the DOC made a high contribution to the total PM (more than 48%)
473 as presented in Table 4. Similar to the observations for gas phase THC that were discussed earlier,

474 particle phase I+SVOC concentrations decreased in two stages, once over the DOC and once over
475 the DPF. The reduction percentage of total particle phase I+SVOC over the DOC was more than
476 74% and over the DOC+DPF was approximately 91%. The DOC can help oxidise the engine-out
477 gas phase SVOC (Liu et al., 2018) and consequently decrease the particle phase I+SVOC collected
478 in the diluted exhaust. Later, when the exhaust gas passes the catalysed DPF, apart from further
479 conversion of I+SVOC, particles are physically trapped. After the DPF, the number of solid core
480 particles is low and consequently less condensation sink is available for the gas phase I+SVOC (if
481 any) to condense/adsorb on them. In the current study, the particle phase I+SVOC measured after
482 the DOC+DPF must have mainly derived from vapour passing the DOC and DPF which condensed
483 on the filters after the dilution, as the DMS showed negligible measureable particles exiting the
484 DPF. It should be borne in mind that the DMS and Nano-Moudi used different dilution systems
485 (described in the experimental setup section) while the conditions of the Nano-Moudi dilution
486 system were more similar to the atmospheric dilution (dilution with only ambient air). Moreover,
487 the utilised comprehensive GC technique has a high sensitivity for measuring small concentrations
488 (a few ng/m^3) of I+SVOC. Although adsorption artefacts are not expected to be very high on the
489 PTFE filters used in this study, a small amount of gas phase I+SVOC condensation and adsorption
490 on stages of the Nano-Moudi at different sampling locations could have happened. Further to the
491 current study, it would be interesting to investigate the effects of varying the dilution conditions
492 such as dilution ratio, temperature, pressure and relative humidity on the concentrations and
493 characteristics of different I+SVOC classes in different particle size ranges.

494

495 Total particle phase I+SVOC mass after the DOC+DPF was approximately $8.9 \text{ mg}/\text{kg}_f$. Gordon et
496 al. (2014) conducted an environmental chamber study and reported emission factors of $<\sim 10 \text{ mg}/\text{kg}_f$
497 for total black-carbon and POA and SOA for medium/heavy-duty diesel vehicles equipped with a
498 catalysed DPF. Although PTFE filters were used for the current study and adsorption artefacts are
499 not expected to be so severe, it may be worthy of mention that May et al. (2013) reported that for

500 the test vehicles equipped with a DPF, up to 90% of the POA collected on the quartz filters from the
501 constant volume sampler were actually adsorbed vapours. It is expected that comprehensive
502 analysis of gas phase I+SVOC after the DPF will clarify gas-particle partitioning under various
503 dilution conditions.

504

505 Among the different I+SVOC classes, alkanes had the highest mass ratio to the total measured PM
506 (Table 4) and I+SVOC (Table 5) at each sampling location. This was expected since the results
507 from earlier analyses of diesel fuel and engine lubricating oil indicated the abundance of alkanes
508 (Funkenbusch et al., 1979; Alam et al., 2016; Zeraati-Rezaei et al., 2016; Alam et al., 2018; Liang
509 et al., 2018). The I+SVOC content found in the particle phase is very similar to that found in the
510 engine lubricating oil (Zeraati-Rezaei et al., 2016; Alam et al., 2018). Alkanes and monocyclic
511 aromatics had the highest conversion efficiency (decrease percentage or removal efficiency) over
512 the DOC and the lowest was for oxygenated compounds (Table 3). These results highlight the lower
513 catalytic reactivity for the cyclic alkanes compared to total normal- and branched-alkanes. Semi-
514 volatile oxygenated compounds, which are believed to be products of combustion of fuel and
515 lubricating oil within the engine, decreased by only ~20% over the DOC and therefore made a
516 higher contribution to the total PM and I+SVOC after the DOC. This can be due to the partial
517 oxidation and breakdown of different compounds over the DOC and their appearance as oxygenated
518 compounds – further discussion is provided later in this section. Generally, the decrease in
519 concentration of all I+SVOC classes was more than 90% over the DOC+DPF except for
520 oxygenated compounds which was approximately 76%. Since the utilised DPF was catalysed, it can
521 be hypothesised that the oxidation process of the gas phase I+SVOC in the DPF was ongoing
522 during the sampling. This process can result in gas phase partial oxidation by-products that can
523 condense/adsorb on the existing particles or the PTFE filter.

524

525 For a more detailed analysis, Figure 4 (a, b, c) illustrates emission factors for different classes of
526 I+SVOC (total alkanes, cycloalkanes, bicyclic alkanes (bicyclics), monocyclic aromatics
527 (monoaromatics) and oxygenated compounds (oxygenates) in different size bins (sampled using the
528 Nano-Moudi) before DOC, after DOC and after DOC+DPF. This figure also includes the
529 conversion efficiency of each class of I+SVOC at each size bin (stage) when using the DOC (Figure
530 4(b)) and DOC+DPF (Figure 4(c)). Contour plots showing particle size and carbon number for each
531 I+SVOC class and measurement location are available in Figure 5 and Supplementary Information,
532 sections C1 to C4. Tables of the raw data ($\mu\text{g}/\text{kg}_f$) containing size bin and carbon number for each
533 class and measurement location can be found in Supplementary Information, sections B1 to B5.

534

535 The peak concentration of total I+SVOC upstream of the DOC was found in the size bin close to
536 100 nm. This is probably due to the higher total mass of particles in this size range – the peak of
537 particle volume shown in Figure 3(b) was at the same particle diameter. This may also indicate that
538 although particles in the accumulation mode are formed of both carbonaceous cores and I+SVOC
539 coatings, their I+SVOC fraction upstream of the DOC is high at this engine condition. Moreover, in
540 the dilution system, due to their high concentration and total surface area, they act as sinks for the
541 available gas phase I+SVOC to condense/adsorb on. It may be worthy of mention that I+SVOC
542 concentration in the size bins >5600 and >10000 nm are relatively high. In the current study,
543 measurement of size distribution for these large particles was not available; however, it is
544 hypothesised that even if their concentrations have been low they could act as sinks for the gas
545 phase I+SVOC as they have large surface areas and are collected on the two top stages in the Nano-
546 Moudi.

547

548 Alkanes were generally the dominant mass fraction in each size bin at the three measurement
549 locations. In terms of conversion efficiency when using the DOC, they generally had the highest
550 values across different stages followed closely by monoaromatics and then bicyclics>cycloalkanes.

551 Oxygenated compounds had the lowest conversion efficiency, if this is a correct interpretation. For
552 oxygenated compounds, as shown in Figure 4 and Supplementary Information, section C4, except
553 for size bins >3200 nm, the size distribution of I+SVOC did not change considerably (reduction
554 percentage was ~20% for all). Therefore, if there were gas phase I+SVOC partial oxidation
555 processes, the by-products were evenly condensed/adsorbed on different particle size bins after the
556 DOC. Conversion efficiency of different classes in the size range of 10 to 18 nm (S13) was
557 relatively low. It should be noted that the concentration of I+SVOC before the DOC was the lowest
558 in this size bin. Due to the small physical size of these particles, their high surface to volume ratio
559 can cause them to adsorb more vapour. When the DPF was added to the system, conversion
560 efficiency of all classes (except oxygenated compounds) in all size ranges was more than
561 approximately 85%.

562

563 Figure 6 illustrates the concentration of different I+SVOC classes based on the carbon number. The
564 presented data is the sum of concentrations available in all of the size bins of the Nano-Moudi. In
565 the results upstream of the DOC, a bimodal distribution of alkanes, based on the carbon number,
566 was found in the particle phase diesel I+SVOC emissions; this has been also reported by Black and
567 High (1979) and Alam et al. (2016). Diesel fuel and engine lubricating oil are the sources of these
568 two peaks; the first peak is from lighter HC in the fuel and the second peak is from heavier HC in
569 the oil.

570

571 Similar to the observations when analysing various lubricating oil samples (Funkenbusch et al.,
572 1979; Zeraati-Rezaei et al., 2016; Alam et al., 2018; Liang et al., 2018), alkanes with carbon
573 number around 24 had the highest contribution to the total amount of I+SVOC collected in the
574 current experiments. C₂₀ had the highest concentration for the oxygenated compounds and C₂₂ had
575 the highest concentration for the rest of the analysed I+SVOC classes.

576

577 The efficiency of the DOC in removing I+SVOC depended on both the class of compounds and
578 carbon number. In the case of alkanes, conversion efficiency of C₂₀ to C₃₄ was a little lower than the
579 rest of the analysed range. Oxidation theory cannot always explain the experimental data,
580 suggesting that there may be other removal mechanisms (Majewski and Khair, 2006). In theory,
581 once the catalyst reaches the light-off temperature for a specific exhaust constituent, the rate of
582 oxidation is controlled by the rate of mass transfer or diffusion rate of that species. This implies that
583 there is more diffusion of low molecular weight HC with higher volatility compared to high
584 molecular weight HC. However, short chain alkanes are known to have higher light-off
585 temperatures compared to longer chain alkanes. As opposed to theory, interestingly, some studies
586 have shown that longer chain HC were removed more efficiently over a catalyst (Eastwood, 2008;
587 Johnson and Kittelson, 1994). Research shows that decreasing C-H bond strength of n-alkanes with
588 increasing their chain length reduces their surface ignition temperature on a catalyst (Veser et al.,
589 1999; Hunter and East, 2002; Diehl et al., 2010), and hence longer chain n-alkanes are more
590 reactive over a catalyst. In addition, this behaviour of the DOC might be partly explained by the fact
591 that there are possibilities that heavier HC can be catalytically cracked into lighter HC (Majewski
592 and Khair, 2006).

593

594 Generally, conversion efficiency of semi-volatile cycloalkanes with higher carbon number was less
595 than the ones with lower carbon number over the DOC. The trend for bicyclic alkanes was similar
596 to the trend for alkanes – higher at the beginning and end of the carbon number range, while C₁₈ and
597 C₁₉ bicyclic alkanes had low conversion efficiencies (<35%). Conversion efficiency of monocyclic
598 aromatics with carbon number ≥ 18 was high (Figure 6). Conversion efficiency of oxygenated
599 compounds with $9 \leq \text{carbon number} \leq 17$ was generally less than 10%. It can be hypothesised that
600 these relatively lighter I+SVOC that appeared after the DOC were by-products of synthesis from
601 partial oxidation of heavier I+SVOC.

602

603 Using the DOC+DPF, reduction percentage of all the classes (except oxygenated compounds) was
604 generally more than 80% for different carbon numbers with the possible exception of low
605 concentration C₁₃ and C₁₄ monocyclic aromatics, although this looks likely to be an artefact of
606 imprecision of the very low concentrations measured.

607

608 **4. SUMMARY AND CONCLUSIONS**

609 Size-resolved physico-chemical characteristics of the intermediate- and semi-volatile particle
610 emissions from a light-duty diesel engine have been investigated upstream and downstream of the
611 diesel oxidation catalyst (DOC) and the catalysed diesel particulate filter (DPF). Particle phase
612 intermediate- and semi-volatile organic compounds (I+SVOC) have been comprehensively
613 characterised based on the compound type (class) and carbon number using a multi-stage Nano
614 impactor and GC×GC-ToF-MS technique. The number size distributions of particles between 1.2-
615 1000 nm have been also investigated. The DOC and the DPF were in an active state for converting
616 hydrocarbons.

617 In samples taken before the DOC, the emission factor for total I+SVOC found in the sub-1000 nm
618 particles was 104.8 mg/kg_f. I+SVOC made a large contribution to the total mass of particles
619 (~49%), and alkanes had the highest mass ratio to the total I+SVOC (~63%). The concentrations of
620 different classes of I+SVOC emissions were ranked as alkanes (65.6 mg/kg_f) >cycloalkanes
621 >monoaromatics =oxygenates >bicyclics (8.2 mg/kg_f). As a summary, Figure 5 shows the
622 concentration of alkanes (the most abundant class similar to the observations in the lubricating oil
623 analysis) with respect to the carbon number and particle diameter. Importantly, before the DOC, the
624 peak concentration of all classes was found in the particle size bin close to 100 nm due to the higher
625 total mass of particles in this size bin. This is indicative of a high concentration of I+SVOC
626 constituents in the accumulation mode particle emissions from the light-duty engine. Before the
627 DOC, alkanes with carbon number around 24 made the largest contribution to the total I+SVOC

628 mass, while C₂₂ had the highest concentration for cycloalkanes, bicyclics and monoaromatics, and it
629 was C₂₀ for the oxygenates.

630 Similar to the gaseous total hydrocarbons, particle phase total I+SVOC emissions decreased in two
631 stages, firstly over the DOC (by ~75%) and then over the DPF (total ~92%). After the DOC, total
632 I+SVOC made a smaller contribution to the total particle mass (~16%). The removal efficiency of
633 different I+SVOC species over the DOC was ranked as monoaromatics (~85%) >alkanes >bicyclics
634 >cycloalkanes >oxygenates (~20%). Using the DOC+DPF system resulted in removal efficiencies
635 of >90% for all classes of I+SVOC except oxygenates which was approximately 76%. Due to the
636 lower removal efficiency of the oxygenates, their concentrations were the highest after alkanes in
637 the measurements after the DOC and DOC+DPF. This was presumably due to the ongoing
638 oxidation of various species inside the DOC and DPF. Some of the lighter I+SVOC that were
639 measured after the aftertreatment devices are believed to be by-products of synthesis and partial
640 oxidation of heavier I+SVOC. Generally, I+SVOC found in the particle size range of 10 nm to 18
641 nm had the lowest removal efficiencies over the DOC probably due to their higher surface to
642 volume ratio which makes them susceptible to adsorb more vapour. With the addition of the DPF,
643 in general, I+SVOC were evenly removed from different particle size bins.

644 High concentrations of sub-2.5 nm particles were measured and the peak was approximately
645 1.9×10^{15} particles/kg_f (dN/dlogdp/kg_f) at around 1.5 nm. This peak decreased by >50% after the
646 DOC and was much lower (1.1×10^{14} parts/kg_f) after the DOC+DPF. These reductions are believed
647 to be due to both the loss of intermediate- and semi-volatile constituents and physical filtration. It is
648 hypothesised that these particles have both volatile and non-volatile constituents.

649

650 The results of this study can be used as an input and validation database for various modelling
651 platforms considering source emissions at low engine loads. In future studies, it is suggested that
652 size-resolved characteristics of I+SVOC and sub-2.5nm particles emissions are investigated under
653 various engine loads and speeds as well as transient engine conditions, and consequently various

654 gas hourly space velocities for the oxidation catalysts and filters as well as active regeneration of
655 the filters. These complementary investigations can eventually help interpret the real driving
656 emissions (RDE) when the engine and aftertreatment systems undergo various operating modes.

657

658 **DATA ACCESSIBILITY**

659 Data supporting this publication are openly available from the UBIRA eData repository at
660 <https://doi.org/10.25500/edata.bham.00000339>.

661

662 **ACKNOWLEDGMENTS**

663 This work is a part of the FASTER project (ERC-2012-AdG, proposal no. 320821) sponsored by
664 the European Research Council (ERC). The work was partially supported by the Natural
665 Environment Research Council through its support of the National Centre for Atmospheric Science
666 (grant number R8/H12/83/011). The authors would like to thank Yasser Al Qahtani and Zhirong
667 Liang for their contribution during engine experiments and Chris Stark for his contribution in GC
668 analysis.

669

670

671 **REFERENCES**

- 672 Airmodus, 2017. A10 Particle Size Magnifier. Available from: <http://www.airmodus.com/a10/>
673 [Accessed 25/01/2017].
674
- 675 Airmodus, 2013. Particle Size Magnifier Model A10 User Manual A13TD0012, A13TD0012 ed.
676
- 677 Alam, M. S., Zeraati-Rezaei, S., Stark, C. P., Liang, Z., Xu, H. and Harrison, R. M., 2016. The
678 characterisation of diesel exhaust particles-composition, size distribution and partitioning, *Faraday*
679 *Discuss.*, 189, 69-84.
680
- 681 Alam, M. S., Zeraati-Rezaei, S., Liang, Z., Stark, C., Xu, H., MacKenzie, A. R. and Harrison R. M.,
682 2018. Mapping and quantifying isomer sets of hydrocarbons ($\geq C_{12}$) in diesel exhaust, lubricating
683 oil and diesel fuel samples using GC \times GC-ToF-MS, *Atmos. Measure. Techn.*, 11, 3047-58.
684
- 685 Alam, M. S., Zeraati-Rezaei, S., Xu, H. and Harrison, R. M., 2019. Characterisation of Gas and
686 Particulate Phase Organic Emissions (C_9 - C_{37}) from a Diesel Engine and the Effect of Abatement
687 Devices, *Environ. Sci. Technol.*, *Environ. Sci. Technol.*, 53, 11345-11352.
688
- 689 Alanen, J., Saukko, E., Lehtoranta, K., Murtonen, T., Timonen, H., Hillamo, R., Karjalainen, P.,
690 Kuuluvainen, H., Harra, J., Keskinen, J., Rönkkö, T., 2015. The formation and physical properties
691 of the particle emissions from a natural gas engine, *Fuel*, 162, 155-161.
692
- 693 Black, F. and High, L., 1979. Methodology for determining particulate and gaseous diesel
694 hydrocarbon emissions, SAE Intl., SAE Techn. Paper 790422, <https://doi.org/10.4271/790422>.
695
- 696 Cambustion, 2015(a). DMS500 Fast Particulate Analyzer - User Manual - Version 4.03.
697
- 698 Cambustion, 2015(b). Cambustion Application Note DMS06 - Real-time Mode Finding &
699 Lognormal Fitting with DMS Series Fast Particulate Spectrometers. Available from:
700 <http://www.cambustion.com/sites/default/files/applications/DMS/dms06v03.pdf> [Accessed
701 16/02/2017 2017].
702
- 703 Cambustion, 2015(c). Cambustion Application Note DMS01 - Particulate Mass Measurement with
704 DMS Series Fast Spectrometers. Available from:
705 <http://www.cambustion.com/sites/default/files/applications/DMS/dms01v05.pdf> [Accessed
706 30/07/2016 2016].
707
- 708 Charron, A. and Harrison, R.M., 2003. Primary particle formation from vehicle emissions during
709 exhaust dilution in the roadside atmosphere, *Atmos. Environ.*, 37, 4109-4119.
710
- 711 Dall'Osto, M., Thorpe, A., Beddows, D.C. S., Harrison, R. M., Barlow, J. F., Dunbar, T., Williams,
712 P. I. and Coe, H., 2011. Remarkable dynamics of nanoparticles in the urban atmosphere, *Atmos.*
713 *Chem. Phys.*, 11, 6623-6637.
714
- 715 Department-for-Transport-UK, 2018. Vehicle Licensing Statistics: Quarter 2 (Apr – Jun 2018).
716 Available from:
717 [https://assets.publishing.service.gov.uk/government/uploads/system/uploads/attachment_data/file/7](https://assets.publishing.service.gov.uk/government/uploads/system/uploads/attachment_data/file/740109/vehicle-licensing-statistics-april-to-june-2018.pdf)
718 [40109/vehicle-licensing-statistics-april-to-june-2018.pdf](https://assets.publishing.service.gov.uk/government/uploads/system/uploads/attachment_data/file/740109/vehicle-licensing-statistics-april-to-june-2018.pdf) [Accessed 09/02/2019 2019].
719

720 Diehl, F., Barbier Jr, J., Duprez, D., Guibard, I. and Mabilon, G., 2010. Catalytic oxidation of
721 heavy hydrocarbons over Pt/Al₂O₃, Influence of the structure of the molecule on its reactivity,
722 Appl. Catal. B-Environ., 95, 217-27.

723 Donahue, N. M., Robinson, A. L., Stanier, C. O. and Pandis, S. N., 2006. Coupled partitioning,
724 dilution, and chemical aging of semivolatile organics, Environ. Sci. Technol., 40, 2635-43.
725

726 Drozd, G. T., Zhao, Y., Saliba, G., Frodin, B., Maddox, C., Oliver Chang, M.-C., Maldonado, H.,
727 Sardar, S., Weber, R. J., Robinson, A. L. and Goldstein, A. H., 2019. Detailed speciation of
728 intermediate volatility and semivolatile organic compound emissions from gasoline vehicles:
729 Effects of cold-starts and implications for secondary organic aerosol formation, Environ. Sci.
730 Technol., 53, 1706-14.
731

732 Eastwood P., 2008. Particulate Emissions from Vehicles, SAE International and Wiley-
733 PEPublishing Series.
734

735 Filippo, A. D. and Maricq M. M., 2008. Diesel nucleation mode particles: semivolatile or solid?,
736 Environ, Sci, Technol., 42, 7957-7962.
737

738 Funkenbusch, E. F., Leddy, D. G. and Johnson J. H., 1979. The characterization of the soluble
739 organic fraction of diesel particulate matter, SAE Intl., SAE Techn. Paper 790418,
740 <https://doi.org/10.4271/790418>.
741

742 Gordon, T. D., Presto, A. A., Nguyen, N. T., Robertson, W. H., Na, K., Sahay, K. N., Zhang, M.,
743 Maddox, C., Rieger, P., Chattopadhyay, S., Maldonado, H., Maricq, M. M. and Robinson, A. L.,
744 2014. Secondary organic aerosol production from diesel vehicle exhaust: impact of aftertreatment,
745 fuel chemistry and driving cycle, Atmos. Chem. Phys., 14, 4643-59.
746

747 Herner, J. D., Hu, S., Robertson, W. H., Huai, T., Chang, M. C. O., Rieger, P. and Ayala. A., 2011.
748 Effect of advanced aftertreatment for PM and NO_x reduction on heavy-duty diesel engine ultrafine
749 particle emissions, Environ. Sci. Technol., 45, 2413-9.
750

751 Heywood, J. B., 1988. Internal Combustion Engine Fundamentals, McGraw-Hill.
752

753 Hietikko, R., Kuuluvainen, H., Harrison, R.M., Portin, H., Timonen, H., Niemi, J.V. and Rönkkö
754 T., 2018. Diurnal variation of nanocluster aerosol concentrations and emission factors in a street
755 canyon, Atmos. Environ., 189, 98-106.
756

757 Huang, L., Bohac, S. V., Chernyak, S. M. and Batterman, S. A., 2015. Effects of fuels, engine load
758 and exhaust after-treatment on diesel engine SVOC emissions and development of SVOC profiles
759 for receptor modeling, Atmos. Environ. 1994, 102, 229-38.
760

761 Hunter, K. C. and East, A. L. L., 2002. Properties of C–C bonds in n-alkanes: Relevance to
762 cracking mechanisms, J. Phys. Chem. A, 106, 1346-56.
763

764 IEA, 2016. Energy and Air Pollution. Available from:
765 [http://www.iea.org/publications/freepublications/publication/WorldEnergyOutlookSpecialReport20](http://www.iea.org/publications/freepublications/publication/WorldEnergyOutlookSpecialReport2016EnergyandAirPollution.pdf)
766 [16EnergyandAirPollution.pdf](http://www.iea.org/publications/freepublications/publication/WorldEnergyOutlookSpecialReport2016EnergyandAirPollution.pdf) [Accessed 01/07/2016 2016].
767

768 ICCT, 2018. European Vehicle Market Statistics, Pocketbook 2018/19. Available from:
769 [https://www.theicct.org/sites/default/files/publications/ICCT_Pocketbook_2018_Final_20181205.p](https://www.theicct.org/sites/default/files/publications/ICCT_Pocketbook_2018_Final_20181205.pdf)
770 [df](https://www.theicct.org/sites/default/files/publications/ICCT_Pocketbook_2018_Final_20181205.pdf) [Accessed 09/02/2019 2019].

771 Järvinen, A., H. Timonen, P. Karjalainen, M. Bloss, P. Simonen, S. Saarikoski, H. Kuuluvainen, J.
772 Kalliokoski, M. Dal Maso, J. V. Niemi, J. Keskinen and T. Rönkkö, 2019. Particle emissions of
773 Euro VI, EEV and retrofitted EEV city buses in real traffic, *Environ. Pollut.*, 250: 708-716.
774

775 Johnson, J. E. and Kittelson, D. B., 1994. Physical factors affecting hydrocarbon oxidation in a
776 diesel oxidation catalyst, SAE Intl., SAE Technical Paper 941771, <https://doi.org/10.4271/941771>.
777

778 Kangasluoma, J., Junninen, H., Lehtipalo, K., Mikkilä, J., Vanhanen, J., Attoui, M., Sipila, M.,
779 Worsnop, D., Kulmala, M. and Petaja, T., 2013. Remarks on ion generation for cpc detection
780 efficiency studies in sub-3-nm size range, *Aerosol Sci. Technol.*, 47, 556-63.
781

782 Kim, C. H., Schmid, M., Schmiege, S. J., Tan, J. and Li, W., 2011. The effect of Pt-Pd ratio on
783 oxidation catalysts under simulated diesel exhaust, SAE Intl., SAE Technical Paper 2011-01-1134,
784 <https://doi.org/10.4271/2011-01-1134>.
785

786 Kittelson D. B., 1998. Engines and nanoparticles: a review, *J. Aerosol Sci.*, 29, 575-88.
787

788 Kittelson, D. B., Watts, W. F., Johnson, J. P., Rowntree, C., Payne, M., Goodier, S., Warrens, C.,
789 Preston, H., Zink, U., Ortiz, M., Goersmann, C., Twigg, M. V., Walker, A. P. and Caldow R., 2006.
790 On-road evaluation of two diesel exhaust aftertreatment devices, *J. Aerosol Sci.*, 37, 1140-51.
791

792 Lähde, T., Rönkkö, T., Virtanen, A., Schuck, T. J., Pirjola, L., Hämeri, K., Kulmala, M., Arnold, F.,
793 Rothe, D. and J. Keskinen, 2009. Heavy duty diesel engine exhaust aerosol particle and ion
794 measurements, *Environ. Sci. Technol.*, 43, 163-8.
795

796 Laurence, R. B., Wong, V. W., Brown, A. J., 1996. Effects of lubrication system parameters on
797 diesel particulate emission characteristics, SAE Intl., SAE Techn. Paper 960318,
798 <https://doi.org/10.4271/960318>.
799

800 Liang, Z., Alam, M. S., Zeraati Rezaei, S., Stark, C., Xu, H. and Harrison, R. M., 2018.
801 Comprehensive chemical characterization of lubricating oils used in modern vehicular engines
802 utilizing GC × GC-TOFMS, *Fuel*, 220, 792-799.
803

804 Liu, Z. G., Eckerle, W. A. and Ottinger, N. A., 2018. Gas-phase and semivolatile organic emissions
805 from a modern nonroad diesel engine equipped with advanced aftertreatment, *JAWMA*, 68, 1333-
806 45.
807

808 Majewski, W. A. and Khair, M. K., 2006. Diesel emissions and their control, 584pp, SAE Intl.,
809 ISBN 10: 0768006740 ISBN 13: 9780768006742.
810

811 May, A. A., Presto, A. A., Hennigan, C. J., Nguyen, N. T., Gordon, T. D. and Robinson, A. L.,
812 2013. Gas-particle partitioning of primary organic aerosol emissions: (2) diesel vehicles, *Environ.*
813 *Sci. Technol.*, 47, 8288-96.
814

815 Nikolova, I., Cai, X., Alam, M. S., Zeraati-Rezaei, S., Zhong, J., MacKenzie, A. R. and Harrison, R.
816 M., 2018. The influence of particle composition upon the evolution of urban ultrafine diesel
817 particles on the neighbourhood scale, *Atmos. Chem. Phys.*, 18, 17143-55.
818

819 Robinson, A. L., Donahue, N. M., Shrivastava, M. K., Weitkamp, E. A., Sage, A. M., Grieshop A.
820 P., Lane, T. E., Pierce, J. R., Pandis, S. N., 2007. Rethinking organic aerosols: Semivolatile
821 emissions and photochemical aging, *Science*, 315, 1259.
822

823 Rönkkö, T., Virtanen, A., Kannosto, J., Keskinen, J., Lappi, M. and Pirjola, L., 2007. Nucleation
824 mode particles with a nonvolatile core in the exhaust of a heavy duty diesel vehicle, *Environ. Sci.*
825 *Technol.*, 41, 6384-9.
826

827 Rönkkö, T., H. Kuuluvainen, P. Karjalainen, J. Keskinen, R. Hillamo, J. V. Niemi, L. Pirjola, H. J.
828 Timonen, S. Saarikoski, E. Saukko, A. Järvinen, H. Silvennoinen, A. Rostedt, M. Olin, J. Yli-
829 Ojanperä, P. Nousiainen, A. Kousa and M. Dal Maso, 2017. Traffic is a major source of
830 atmospheric nanocluster aerosol., *Proceedings of the National Academy of Sciences* 114(29): 7549.
831

832 Sakurai, H., Tobias, H. J., Park, K., Zarling, D., Docherty, K. S., Kittelson, D. B., McMurry, P. H.,
833 Ziemann, P. J., 2003. On-line measurements of diesel nanoparticle composition and volatility,
834 *Atmos. Environ.*, 37, 1199-210.
835

836 Sgro, L. A., Sementa, P., Vaglieco, B. M., Rusciano, G., D'Anna, A. and Minutolo, P., 2012.
837 Investigating the origin of nuclei particles in GDI engine exhausts, *Combust. Flame*, 159, 1687-
838 1692.
839

840 Shi, J. P. and Harrison, R. M., 1999. Investigation of ultrafine particle formation during diesel
841 exhaust dilution, *Environ. Sci. Technol.*, 33, 3730-3736.
842

843 Shi, J. P., Mark, D. and Harrison, R. M., 2000. Characterization of particles from a current
844 technology heavy-duty diesel engine, *Environ. Sci. Technol.*, 34, 748-55.
845

846 Stone, R., 1999. *Introduction to Internal Combustion Engines*. Third ed., MacMillan Press Ltd.
847

848 Swanson, J. J., Kittelson, D. B., Watts, W. F., Gladis, D. D. and Twigg, M. V., 2009. Influence of
849 storage and release on particle emissions from new and used CRTs, *Atmos. Environ.*, 43, 3998-
850 4004.
851

852 Tiszenkel, L., C. Stangl, J. Krasnomowitz, Q. Ouyang, H. Yu, M. J. Apsokardu, M. V. Johnston and
853 S.-H. Lee, 2019. Temperature effects on sulfuric acid aerosol nucleation and growth: initial results
854 from the TANGENT study. *Atmos. Chem. Phys*, 19(13): 8915-8929.
855

856 Vesper, G., Ziauddin, M. and Schmidt, L. D., 1999. Ignition in alkane oxidation on noble-metal
857 catalysts, *Catalysis Today*, 47, 219-28.
858

859 Zeraati-Rezaei, S., Alam, M. S., Liang, Z., Stark, C. P., Harrison, R. M. and Xu, H., 2016.
860 Investigation of SVOC in diesel fuel, engine lubricating oil and diesel engine emissions, Cambridge
861 Particle Meeting, University of Cambridge.
862

863 Zhao, Y., Nguyen, N. T., Presto, A. A., Hennigan, C. J., May, A. A. and Robinson, A. L., 2015.
864 Intermediate volatility organic compound emissions from on-road diesel vehicles: Chemical
865 Composition, emission factors, and estimated secondary organic aerosol production, *Environ. Sci.*
866 *Technol.*, 49, 11516-26.
867

868 **NOMENCLATURE**

Acc.	Accumulation mode (also referred to as soot mode)
Bicyclics	Bicyclic alkanes
BMEP	Brake mean effective pressure
CI	Compression ignition
CLD	Chemiluminescence detection
CLIC	Computer language for identifying chemical
CMD	Count median diameter
CO	Carbon monoxide
CO ₂	Carbon dioxide
CPC	Condensation particle counter
DCM	Dichloromethane
DI	Direct-injection
DMA	Differential mobility analyser
DOC	Diesel oxidation catalyst
DPF	Diesel particulate filter
EGR	Exhaust gas recirculation
FID	Flame ionisation detector
GC	Gas chromatography
GC×GC	Two-dimensional gas chromatography
GC×GC-ToF-MS	Two dimensional gas chromatography time-of-flight mass spectrometry
g/kg _f	Grams per kilogram of fuel consumed
HC	Hydrocarbons
HEPA	High-efficiency-particulate-air
H ₂ SO ₄	Sulphuric acid
I+SVOC	IVOC+SVOC
IVOC	Intermediate-volatility organic compounds
mg/kg _f	Milligrams per kilogram of fuel consumed
Monoaromatics	Monocyclic aromatics
MPA	Magneto-pneumatic
MS	Mass spectrometry
Nano-Moudi	Nano-micro orifice uniform deposit impactor
NDIR	Non-dispersive Infra-Red

NEDC	New European driving cycle
NO	Nitrogen monoxide
NO ₂	Nitrogen dioxide
NO _x	Oxides of nitrogen
Nuc.	Nucleation mode
O ₂	Oxygen
Open-ECU	Open engine control unit
Oxygenates	Oxygenated compounds
PAH	Polycyclic aromatic hydrocarbons
PM	Particle mass
POA	Primary organic aerosol
PSM	Particle size magnifier
RDE	Real driving emissions
RPM	Revolutions per minute
SCR	Selective catalytic reduction system
SOA	Secondary organic aerosol
SVOC	Semi-volatile organic compounds
THC	Total hydrocarbons
ToF	Time of flight
UCM	Unresolved complex mixture
VNT	Variable-nozzle-turbine

870 **TABLES LEGENDS**

871 **Table 1:** Engine specifications.

872

873 **Table 2:** Gaseous emissions characteristics (Red. % means the percentage of decrease of each
874 parameter over the aftertreatment systems).

875

876 **Table 3:** Particle mass (PM) and I+SVOC emissions characteristics.

877

878 **Table 4:** Mass ratio of each class of I+SVOC to the total particle mass (PM).

879

880 **Table 5:** Mass ratio of each class of I+SVOC to the total I+SVOC.

881

882

883 **FIGURES LEGENDS**

884 **Figure 1:** Schematic of the engine test cell.

885 DAQ refers to the data acquisition board,

886 * samples were taken before DOC, after DOC and after DOC+DPF.

887

888 **Figure 2:** Schematic of the dilution and sample collection system.

889 * this flow meter (rotameter) was used to assure flow rates and was removed during
890 sampling

891

892 **Figure 3:** Particle size distribution (a) number and (b) volume at different sampling locations.

893 (Particles with diameter between 1.2 nm and 2.5 nm were measured with the PSM

894 sampling system and particles with diameter between 4.87 nm and 1000 nm (the grey

895 area) were measured with the DMS sampling system).

896

897 **Figure 4:** Total I+SVOC concentrations at different exhaust particle sizes collected by the

898 Nano-Moudi; (a) Before DOC, (b) After DOC, (c) After DOC+DPF (bars represent

899 the concentrations and lines represent conversion efficiencies using DOC (b) and

900 DOC+DPF (c)).

901

902 **Figure 5:** Contour plots of intermediate- and semi-volatile alkane concentrations collected by

903 the Nano-Moudi at different sampling locations.

904

905 **Figure 6:** Concentrations and conversion efficiencies of different types of I+SVOC (collected

906 by the Nano-Moudi) versus their carbon number at different sampling locations (bars

907 represent the concentrations, and lines represent conversion efficiencies using DOC

908 (red lines / lower conversion efficiencies) and DOC+DPF (green lines / higher

909 conversion efficiencies)).

910

911

912 **Table 1:** Engine specifications.

Bore (mm)	86.0
Stroke (mm)	94.6
Connecting Rod Length (mm)	155.0
Capacity (cm ³)	2198
Compression Ratio	15.5:1
Injection System	DI Common Rail (Solenoid Injectors)

913

914

915 **Table 2:** Gaseous emissions characteristics (Red. % means the percentage of decrease of each
 916 parameter over the aftertreatment systems).

	CO	THC	NO	NO ₂	NO _x	CO ₂	Exhaust Gas Temperature
	g/kg _f						°C
Before DOC	97.92	19.97	0.83	4.07	4.90	3015	186
After DOC	2.16	7.62	3.06	0.00	3.06	3209	209
After DOC+DPF	0.00	2.33	2.83	0.03	2.85	3228	206
Red. (DOC) %	97.79	61.85	-270.45	99.99	37.49	-6.4	-12.6
Red. (DOC+DPF) %	100.00	88.32	-241.93	99.32	41.74	-7.1	-10.7

917 Exhaust backpressure difference before and after the aftertreatment system was approximately 5.4 mbar.

918

919 **Table 3:** Particle mass (PM) and I+SVOC emissions characteristics.

	I+SVOC								
	Total PM	Total I+SVOC	Nuc. PM	Acc. PM	Alkanes	Cyclo-alkanes	Bicyclic Alkanes	Monocyclic Aromatics	Oxygenated Compounds
	g/kg _f								
Before DOC	0.2156	0.1048	0.0094	0.2063	0.0656	0.0122	0.0082	0.0094	0.0094
After DOC	0.1696	0.0265	0.0032	0.1664	0.0115	0.0043	0.0018	0.0014	0.0075
After DOC+DPF	0.0000	0.0089	0.0000	0.0000	0.0045	0.0012	0.0005	0.0006	0.0022
Red. (DOC) %	21.36	74.71	65.84	19.34	82.51	65.09	77.64	84.79	20.08
Red. (DOC+DPF) %	100.00	91.50	100.00	100.00	93.16	90.34	94.37	93.90	76.49

920 PM is from the DMS sampling system and I+SVOC is from the Nano-Moudi sampling system using the in-house
 921 dilution system

922

923 **Table 4:** Mass ratio of each class of I+SVOC to the total particle mass (PM).

	Alkanes	Cyclo-alkanes	Bicyclic Alkanes	Monocyclic Aromatics	Oxygenated Compounds	Total I+SVOC
	%					
Before DOC	30.4	5.7	3.8	4.4	4.4	48.6
After DOC	6.8	2.5	1.1	0.8	4.4	15.6
After DOC+DPF	-	-	-	-	-	-

924 PM is from the DMS sampling system and I+SVOC is from the Nano-Mouidi sampling system using the in-house
925 dilution system

926

927 **Table 5:** Mass ratio of each class of I+SVOC to the total I+SVOC.

	Alkanes	Cyclo-alkanes	Bicyclic Alkanes	Monocyclic Aromatics	Oxygenated Compounds
	%				
Before DOC	62.6	11.7	7.8	9.0	9.0
After DOC	43.3	16.1	6.9	5.4	28.3
After DOC+DPF	50.4	13.2	5.2	6.4	24.8

928 I+SVOC is from the Nano-Moudi sampling system using the in-house dilution system

929

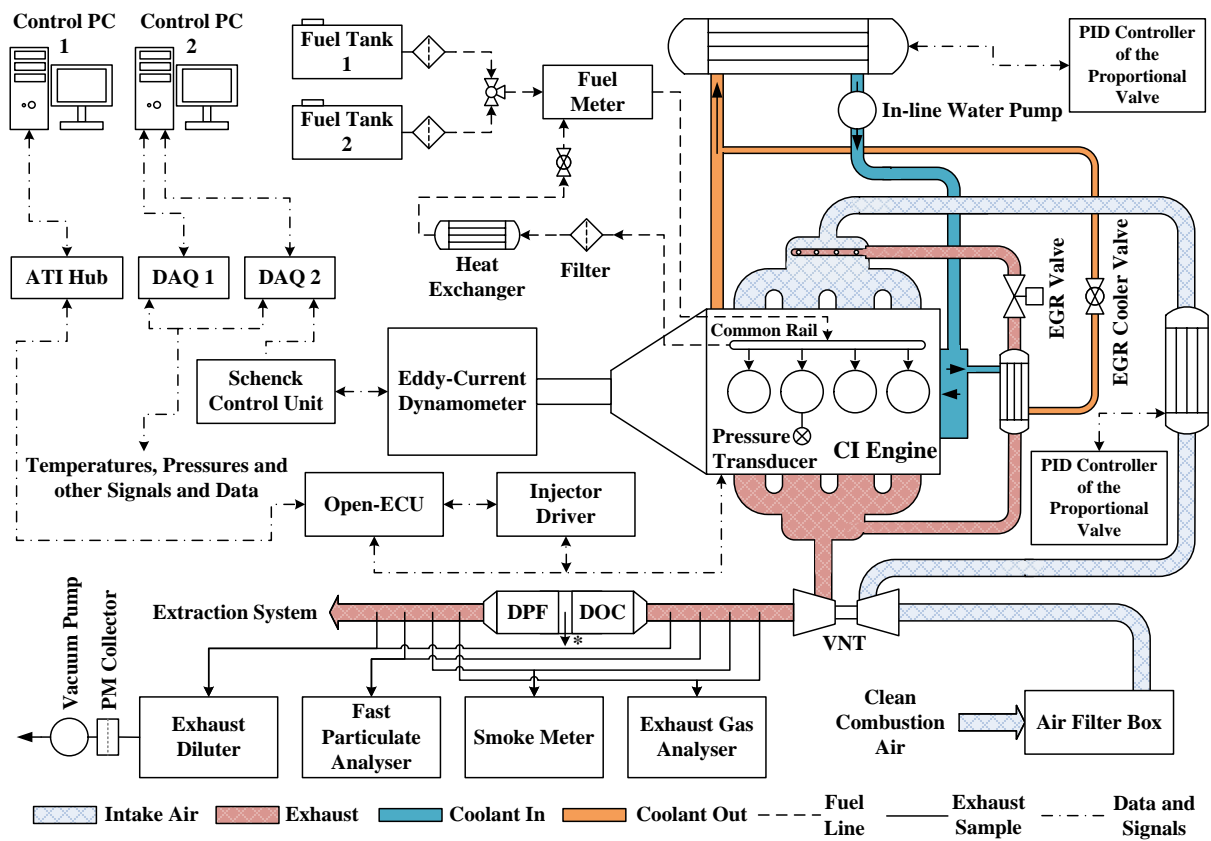

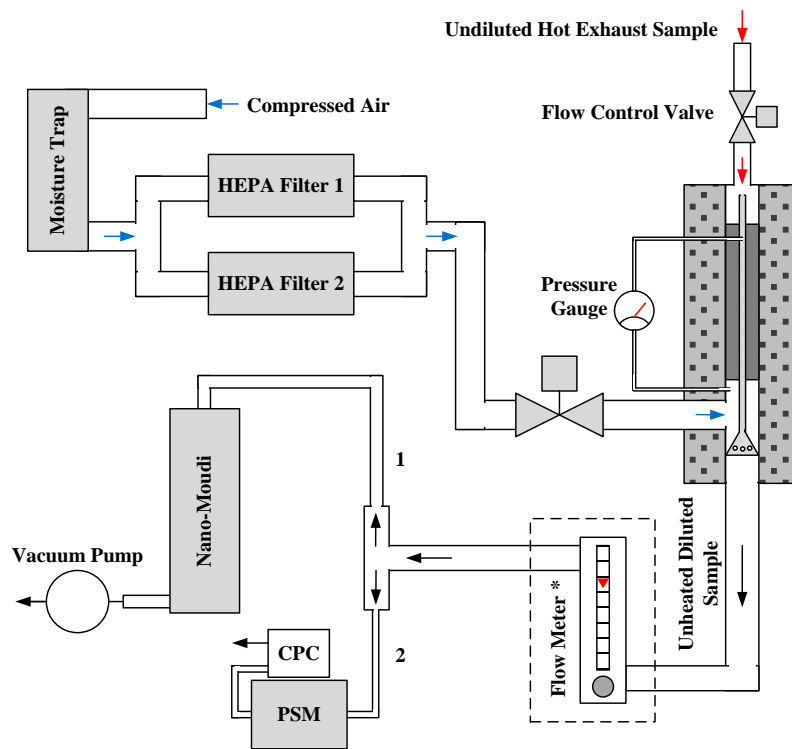

935

936 **Figure 2:** Schematic of the dilution and sample collection system.

937 * this flow meter (rotameter) was used to assure flow rates and was removed during sampling

938

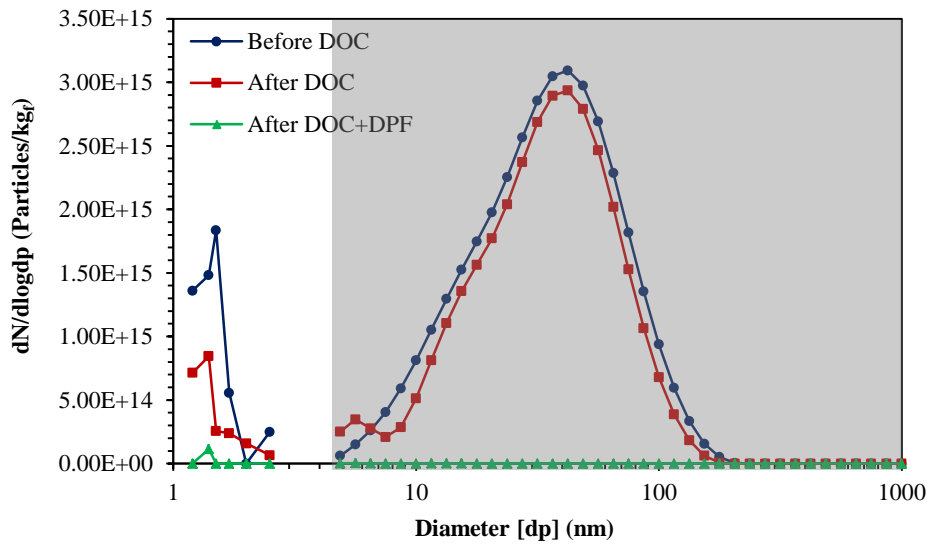

(a)

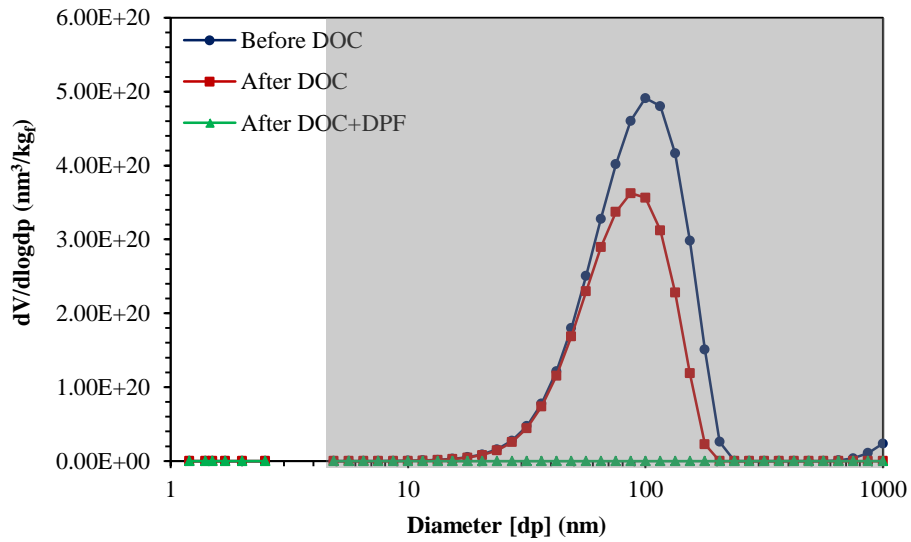

(b)

939
940

941
942
943
944
945
946
947

Figure 3: Particle size distribution (a) number and (b) volume at different sampling locations. (Particles with diameter between 1.2 nm and 2.5 nm were measured with the PSM sampling system and particles with diameter between 4.87 nm and 1000 nm (the grey area) were measured with the DMS sampling system).

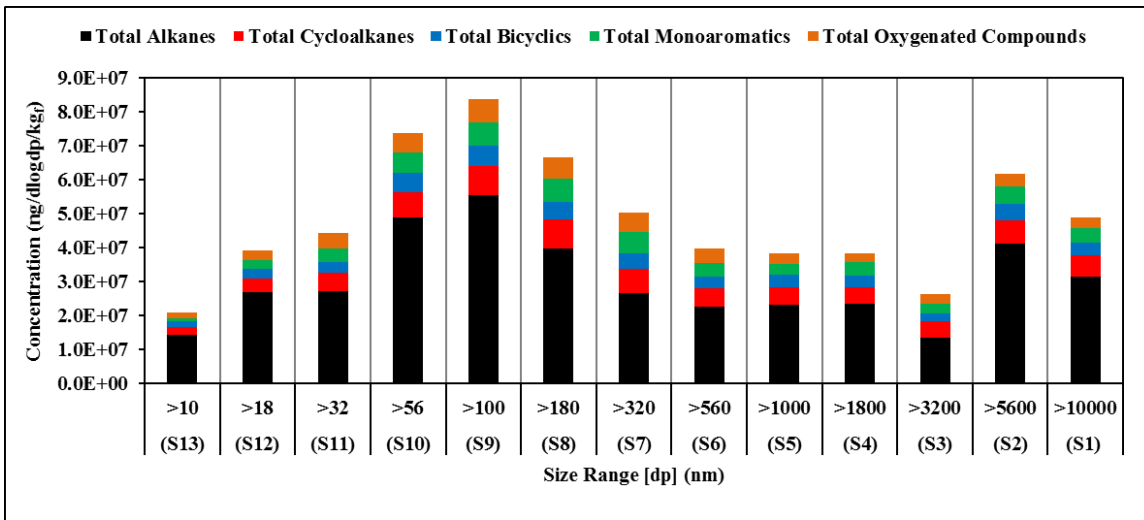

948
949

(a)

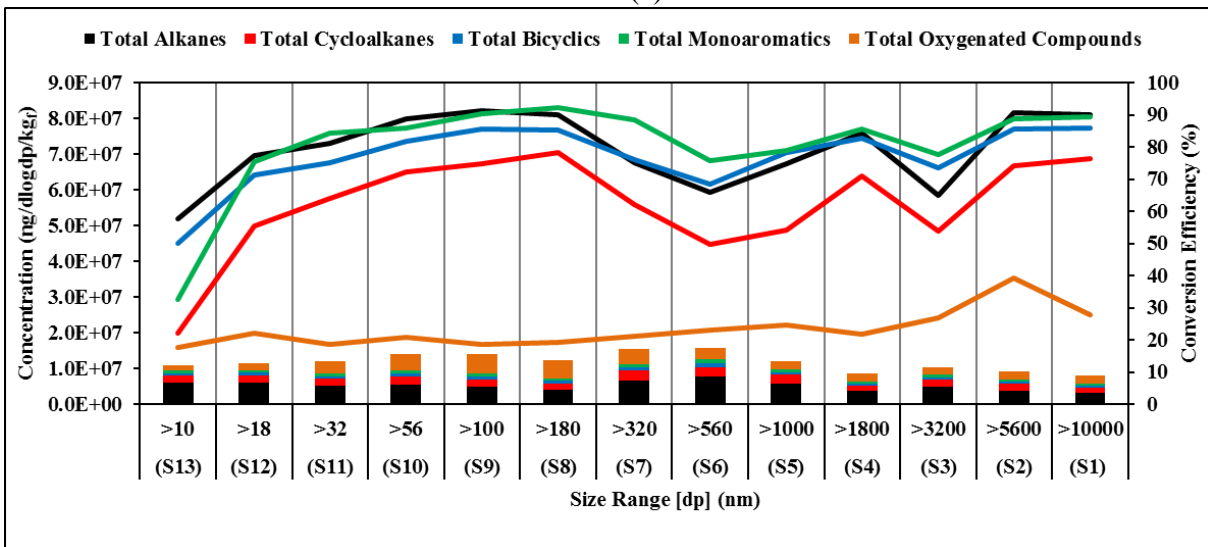

950
951

(b)

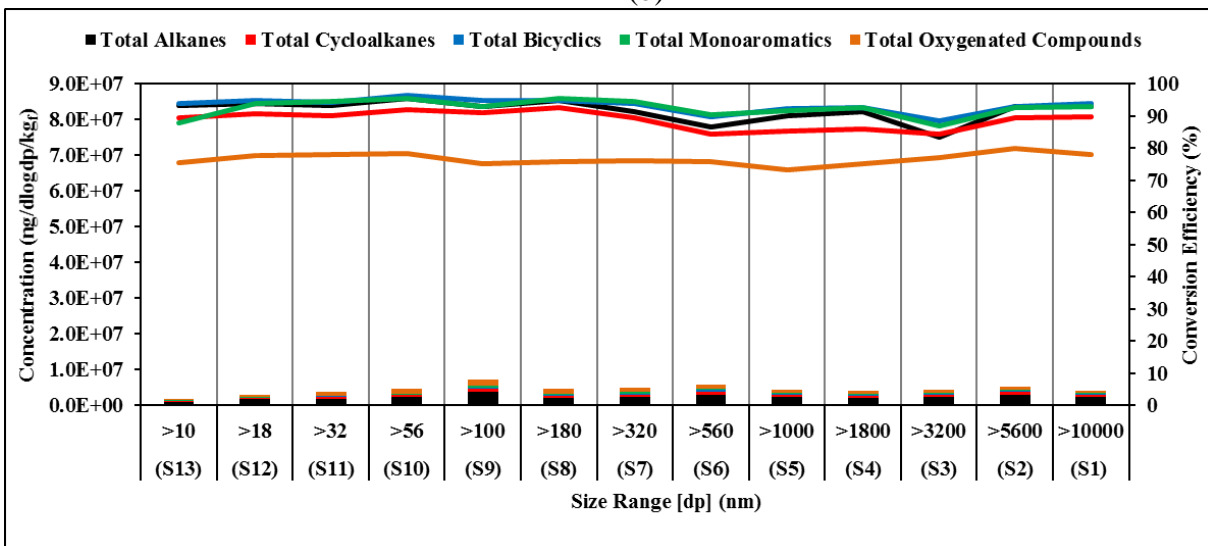

952
953

(c)

Figure 4: Total I+SVOC concentrations at different exhaust particle sizes collected by the Nano-Moudi; (a) Before DOC, (b) After DOC, (c) After DOC+DPF (bars represent the concentrations and lines represent conversion efficiencies using DOC (b) and DOC+DPF (c)).

956
957

958

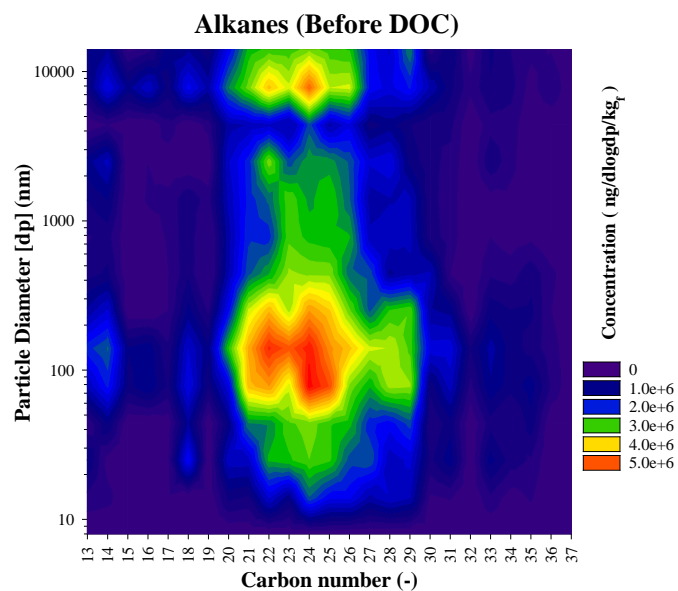

959

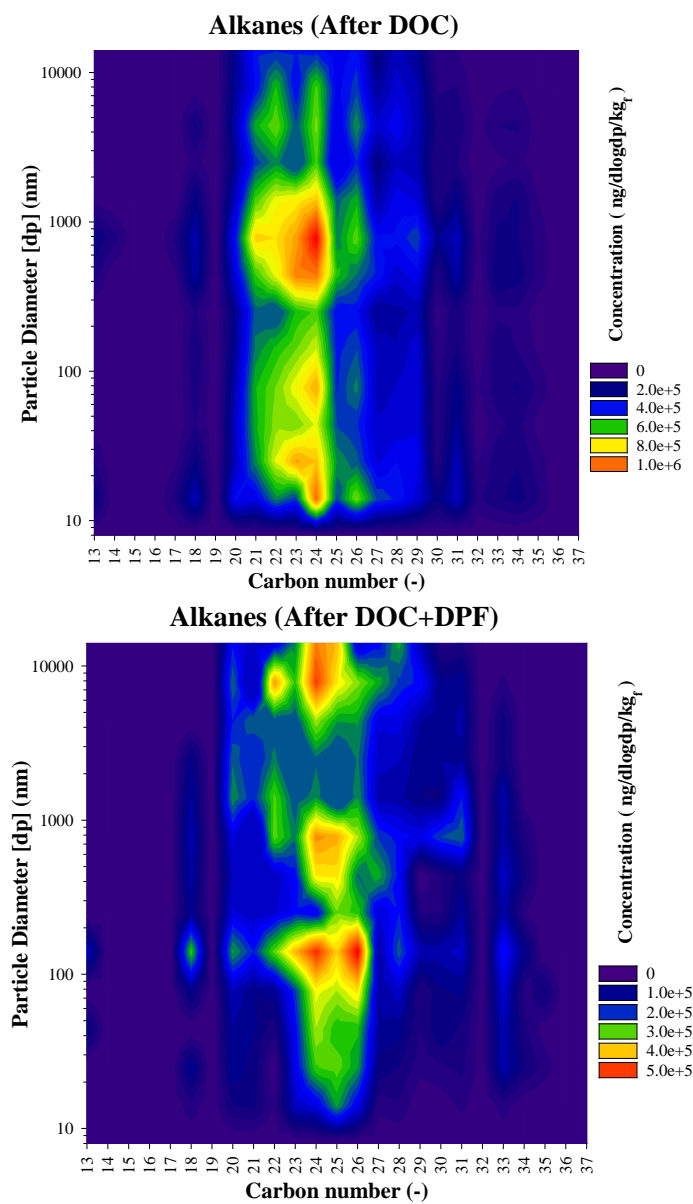

960

961

962

963

Figure 5: Contour plots of intermediate- and semi-volatile alkane concentrations collected by the Nano-Moudi at different sampling locations.

964

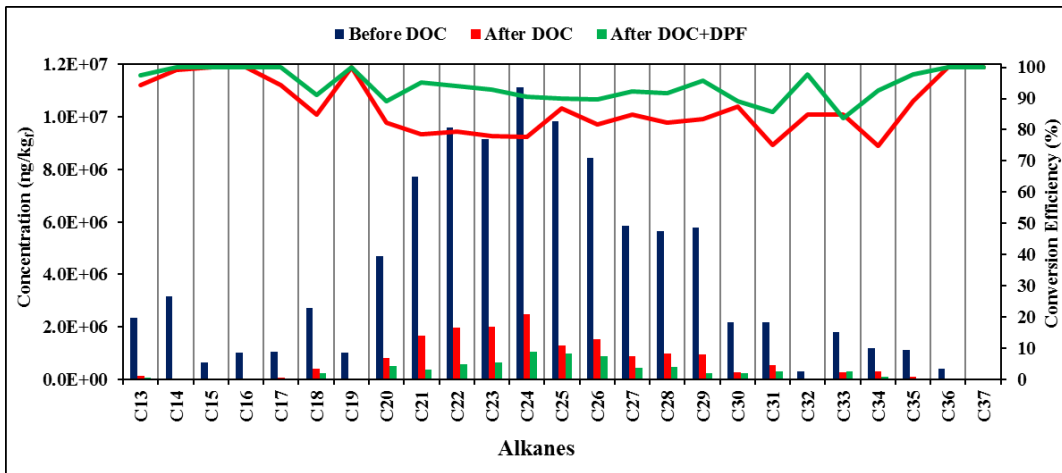

965

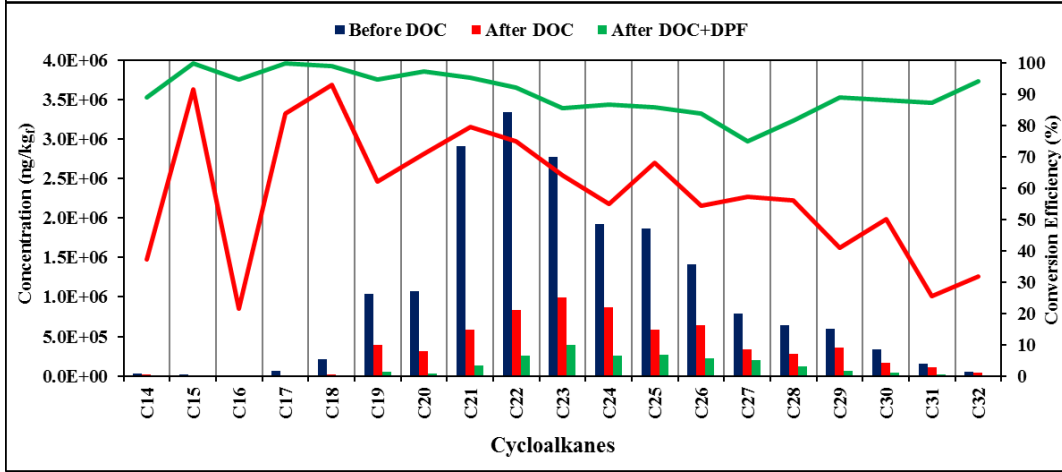

966

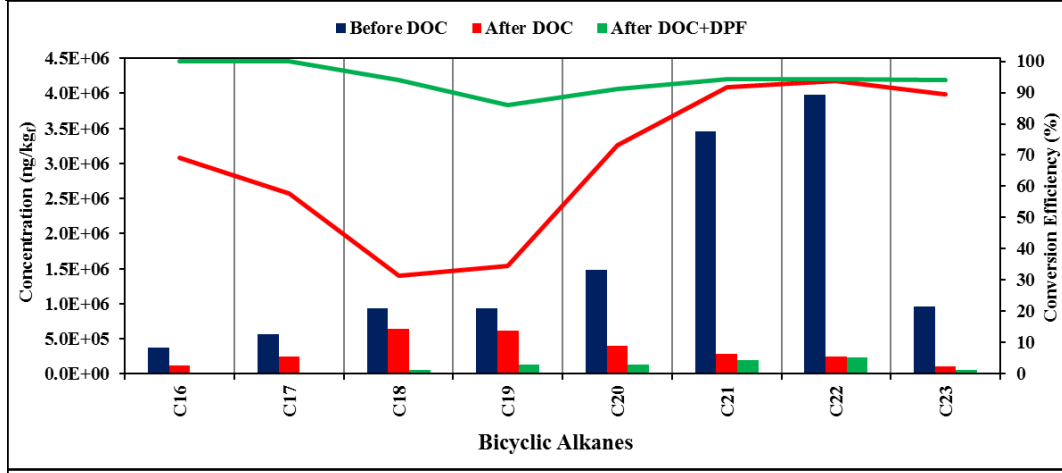

967

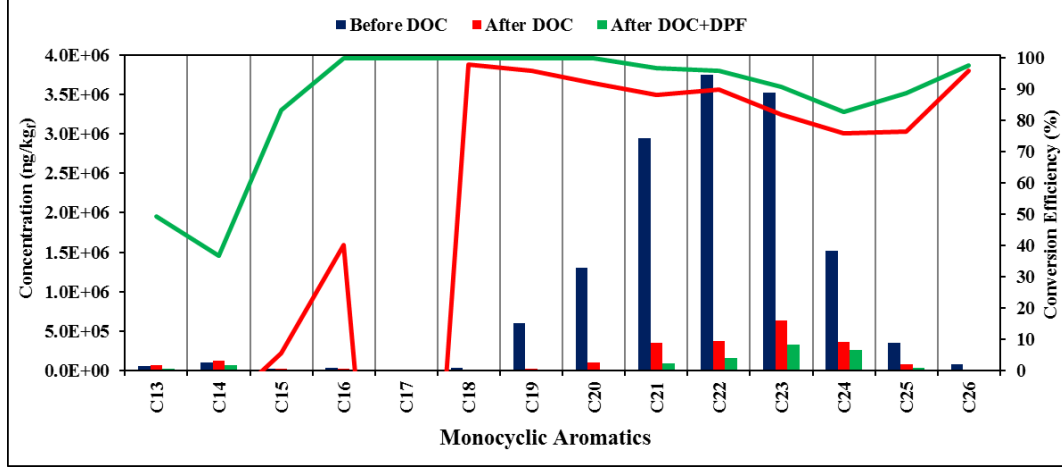

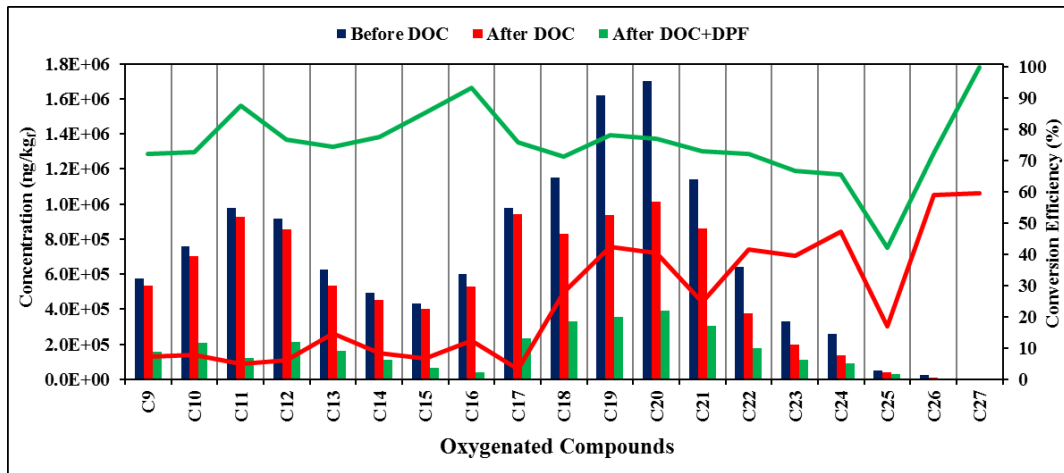

968
 969
 970
 971
 972
 973
 974
 975

Figure 6: Concentrations and conversion efficiencies of different types of I+SVOC (collected by the Nano-Moudi) versus their carbon number at different sampling locations (bars represent the concentrations, the lines represent conversion efficiencies using DOC (red lines / lower conversion efficiencies) and DOC+DPF (green lines / higher conversion efficiencies)).