

Illusions of integration are subjectively impenetrable

Simione, Luca; Akyürek, Elkan G; Vastola, Valentina; Raffone, Antonino; Bowman, Howard

DOI:

[10.1016/j.concog.2017.03.004](https://doi.org/10.1016/j.concog.2017.03.004)

License:

Creative Commons: Attribution-NonCommercial-NoDerivs (CC BY-NC-ND)

Document Version

Peer reviewed version

Citation for published version (Harvard):

Simione, L, Akyürek, EG, Vastola, V, Raffone, A & Bowman, H 2017, 'Illusions of integration are subjectively impenetrable: Phenomenological experience of Lag 1 percepts during dual-target RSVP', *Consciousness and Cognition*, vol. 51, pp. 181-192. <https://doi.org/10.1016/j.concog.2017.03.004>

[Link to publication on Research at Birmingham portal](#)

General rights

Unless a licence is specified above, all rights (including copyright and moral rights) in this document are retained by the authors and/or the copyright holders. The express permission of the copyright holder must be obtained for any use of this material other than for purposes permitted by law.

- Users may freely distribute the URL that is used to identify this publication.
- Users may download and/or print one copy of the publication from the University of Birmingham research portal for the purpose of private study or non-commercial research.
- User may use extracts from the document in line with the concept of 'fair dealing' under the Copyright, Designs and Patents Act 1988 (?)
- Users may not further distribute the material nor use it for the purposes of commercial gain.

Where a licence is displayed above, please note the terms and conditions of the licence govern your use of this document.

When citing, please reference the published version.

Take down policy

While the University of Birmingham exercises care and attention in making items available there are rare occasions when an item has been uploaded in error or has been deemed to be commercially or otherwise sensitive.

If you believe that this is the case for this document, please contact UBIRA@lists.bham.ac.uk providing details and we will remove access to the work immediately and investigate.

Illusions of Integration are Subjectively Impenetrable: Phenomenological Experience of Lag 1 Percepts during Dual-target RSVP.

Luca Simione^{1,2}, Elkan G. Akyürek³, Valentina Vastola², Antonino Raffone^{2,4}, & Howard Bowman^{5,6}

1. ISTC, Institute of Cognitive Sciences and Technologies, CNR, Rome, Italy.
2. Department of Psychology, “Sapienza” University of Rome, Italy.
3. Department of Psychology, Experimental Psychology, University of Groningen, The Netherlands.
4. ECONA, Interuniversity Center, Rome, Italy.
5. Centre for Cognitive Neuroscience and Cognitive Systems, School of Computing, University of Kent, Canterbury, Kent, UK.
6. School of Psychology, University of Birmingham, UK.

Abstract

We investigated the relationship between different kinds of target reports in a rapid serial visual presentation task, and their associated perceptual experience. Participants reported the identity of two targets embedded in a stream of stimuli and their associated subjective visibility. In our task, target stimuli could be combined together to form more complex ones, thus allowing participants to report temporally integrated percepts. We found that integrated percepts were associated with high subjective visibility scores, whereas reports in which the order of targets was reversed led to a poorer perceptual experience. We also found a reciprocal relationship between the chance of the second target not being reported correctly and the perceptual experience associated with the first one. Principally, our results indicate that integrated percepts are experienced as a unique, clear perceptual event, whereas order reversals are experienced as confused, similar to cases in which an entirely wrong response was given.

Keywords: temporal integration, perceptual awareness, subjective visibility, order errors, RSVP.

1. Introduction

Our ability to attend to objects and events in the environment is not limitless. One well-known attentional constraint is demonstrated by the attentional blink (AB) phenomenon, which is the difficulty associated with identifying the second of two target stimuli when they arrive within about half a second from each other (Broadbent & Broadbent, 1987; Raymond, Shapiro, & Arnell, 1992). Somewhat paradoxically, however, the AB often does not seem to take effect immediately: when targets follow each other directly, without intervening distractors, in the so-called Lag 1 condition, target identification can be very high (Visser, Bischof, & Di Lollo, 1999). Such cases thus seem to afford an escape from the AB, even though the time to process both targets at Lag 1 is the most limited.

It has also been observed, however, that the high rate of target identification at Lag 1 does not come without costs. In particular, the order in which targets appeared seems to be frequently lost. Instead of reporting the targets in their proper order, observers often reverse them, committing an “order reversal” (or “swap”) error. The loss of order information at Lag 1 supports the idea that the targets are temporally integrated into a single episodic event (trace), within which target-specific timestamps are unavailable (Hommel & Akyürek, 2005). This has been modelled formally in the Simultaneous Type/ Serial Token (STST) model by Bowman and Wyble (2007), in which an incorrect binding of target identities, or *types*, and episodic events, or *tokens*, can occur.

The STST model provides a theory of temporal attention and working memory (Bowman & Wyble, 2007). It gives a comprehensive account of the attentional blink phenomenon and associated effects (Bowman & Wyble, 2007; Wyble et al, 2009). The model has two versions – the original STST model (Bowman & Wyble, 2007) and the episodic STST (eSTST) model (Wyble et al, 2009). Central to both STST models is the idea that perceptual processing has two stages (Chun & Potter, 1995). The first of these performs object detection, providing, in the terminology of the model, representations of types, i.e. activation of neural assemblies defining *what* a presented stimulus is. In the second stage, active types are associated with active tokens, see figure 1. Tokens represent *when* a stimulus / type occurred. Thus, the presentation of the symbol “O” in one of our experiments would cause its corresponding type to become active, which in turn would be associated with a token indicating when it occurred relative to other types, see figure 1, again. It is this second stage – the association of types with tokens – that is relevant to this paper.

We will focus here on the STST model rather than eSTST. This is because its notion of token is more in keeping with the sort of integrations we will be considering in this paper. More specifically, the notion of token changes somewhat between STST and eSTST. In the latter model, each type has its own unique token, and the time point at which a type is registered to have occurred (relative to other types) is determined by the time-point at which its token commits. It is not so clear

how this eSTST model would generate combined percepts, as arise when integration errors are made. However, STST relatively naturally models such integrations, as described shortly.

In STST, it is frequently the case that at Lag 1, both targets (in fact, strictly their types) are bound into a single token. This corresponds to a complete loss of order information while combining the targets' identities, i.e., integration into a single episode. In fact, there are four kinds of encoding outcome that can arise from the STST model when presented with a Lag 1 sequence (Fig. 1). Which of these the model generates depends upon the relative input strength of the two target types: perfect performance (Panel A), in which tokens are correctly associated with types, i.e., according to the stimulus presentation stream; pure order error (Panel B), in which tokens are associated in the wrong order, but without an ambiguity, so that no trace is left to indicate that this is a mis-binding; impure order error (Panel C), in which one type has its binding smeared across two tokens, which yields another order error; and single episode (Panel D), in which both types are associated with the first token and none with the second. In the standard dual target RSVP paradigms, in which targets remain uniquely reportable items, observers may have to guess more or less blindly at their order, when faced with the single episode outcome. However, in a paradigm such as that in this paper (detailed below), an integrated target report would be expected to arise in this case.

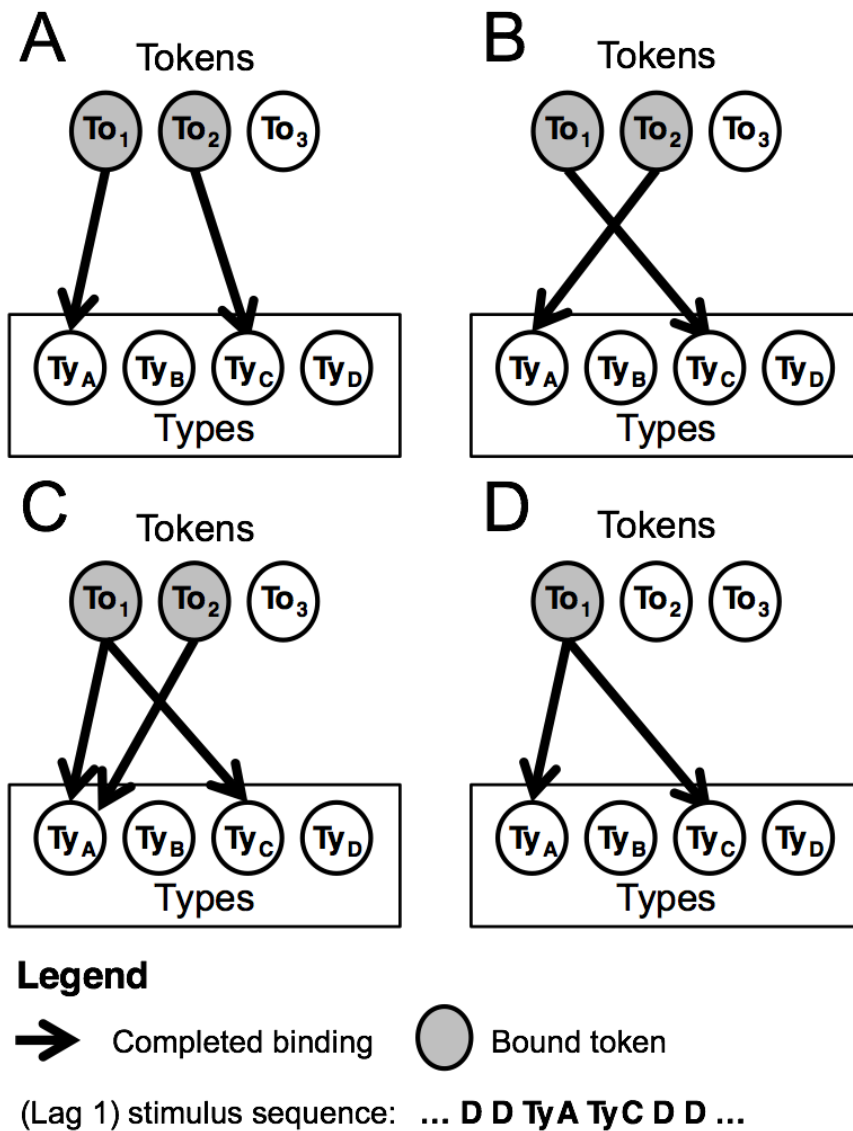

Figure 1. Potential encoding outcomes arising from the STST model when presented with a Lag 1 sequence. *D* denotes an arbitrary distractor; Ty_K type K ; and To_h token h . There are four potential binding outcomes that the model can generate: A) perfect performance; B) pure order error, C) impure order error, and D) single episode. B) and C) may be viewed as forms of prior entry.

Confirmatory evidence for temporal target integration was recently obtained by Akyürek and colleagues (2012), by using a target set that enabled not only individual report of targets, but also of combined pairs. In one experiment, for instance, symbols that looked like “\”, “/”, and “X” were part of the set; the integration of the first two results in the third, which itself is a valid target identity. With such targets, at Lag 1, observers indeed frequently reported seeing only a single target stimulus, merging the features of the first and second target (T_1 and T_2). Moreover, these reports occurred up to approximately three times as often as (real) order reversals, which also still occurred.

Losing some order sensitivity due to temporal integration, in exchange for featural

precision and for escaping the AB, may seem like a modest price to pay. Indeed, in most natural perceptual tasks, there are likely to be few instances in which it would be preferable to discern ~80 ms intervals from one another, over perceiving longer, aggregated events, which likely contain more meaningful information. However, it is important to determine whether there are further hidden costs to such integration. It is conceivable that the integrated representation of two targets is more fragile, less clear, or even less precise than that of two separate targets that were successfully perceived. For instance, within one event, the aggregate featural information from multiple stimuli might cause more confusion, or even risk overloading the perceptual system. Targets might also compete with each other more strongly once they are part of the same event (Hommel & Akyürek, 2005).

In the RSVP tasks used to date, such detrimental effects may go unnoticed, because the report that is asked of the participants does not directly probe the clarity of the resulting representations, and the observers might succeed in reporting the target features themselves because these do not require fine discriminations. There is one study to date that has looked at pupil dilation associated with target report accuracy, which may shed some light on this issue. Wolff and colleagues (2015) examined pupil dilation as a measure of mental effort, dependent on the different types of report that their observers made. Pupil dilations associated with correct reports of two targets, of one target, and integration reports were contrasted. The authors found that pupil dilation (and thus, it would be expected, mental effort) was lowest for single target and integration reports, while two-target reports resulted in increased dilation. It is tempting to conclude that integration, which comprises all features of both targets, affords the processing of two targets at the price of one. Yet, although this may be true for mental effort, it is not clear whether perceptual clarity was not impaired, even if still good enough for behavioural report; in this sense the study only provides corroborative evidence.

The present study sought to resolve the issue of perceptual clarity during temporal integration. One way to address this might be to require such fine featural discriminations that slight losses might be detectable when integration and individual target reports are compared. However, this approach runs into practical problems; pilot experiments showed that target identification rates tend to drop off steeply in such designs, even when targets consisted of just 6 possible visual features. Fortunately, there is an established method by which the perceptual experience can be probed: the Perceptual Awareness Scale (PAS), proposed by Overgaard et al. (2006). This scale allows participants to report directly what they experience, rather than report only about stimulus features. Overgaard et al. (2006) argued that correct reports about stimulus features can be dissociated from reports about experience, effectively allowing study of the contents of conscious experience. In the present study, the PAS was combined with the proven RSVP integration

procedure used in Akyürek et al. (2012), so that perceptual awareness associated with behavioural reports of single targets, dual targets, and integrations can be compared. Furthermore, dual target reports can subsequently be divided into order-correct and order-incorrect (real order reversal) reports, which provide a measure of differences in perceptual awareness due to the loss of order information, apart from temporal integration.

Another important point that could be addressed with such a procedure is the relationship between the process of target consolidation in memory and its perceptual experience. In fact, most theories of consciousness consider the representations in working memory as the only ones available for conscious report. They also support the views that the consolidation of a representation means that it has been consciously perceived and that conscious access is based upon the material consolidated into working memory (Baars & Franklin, 2003; Block, 2007; Lamme, 2006). Accordingly, AB studies often consider working memory consolidation and conscious access of information to be overlapping, indeed often identical, processes (Nieuwenhuis & de Kleijn, 2011; Sergent & Dehaene, 2004; but see Pincham, Bowman, & Szucs, 2016). Interestingly, most neural models of the AB attribute the lack of consciousness or the poor conscious experience associated with the second target to the dynamics of consolidation into memory, but some of them claim that a target is ‘protected’ from the influence of another incoming target, during its consolidation into memory (Craston, Wyble, Chennu, & Bowman, 2009; Simione et al., 2012). We would thus also like to assess if the processes of perceiving and consolidating the second target vary with the conscious experience associated with the first target.

2. Materials and methods

2.1. Participants

Twenty volunteers (15 females; Mean age=24.75, Range=22-30) from “Sapienza”, University of Rome, took part in the experiment. We removed one participant from the analysis because of a technical problem. The final data set included 19 participants (14 females; Mean age=24.71, Range=22-30). All participants gave informed consent in accordance with the Declaration of Helsinki after verbal and written explanation of the procedures involved in the study.

2.2. Materials

The targets consisted of all possible combinations of the capital letter O and the forward and backward slash (“/” and “\”) symbols, as shown in Figure 2. These were coloured in blue. The targets were chosen in such a way that their features did not overlap with each other (i.e., the same line or the O was never shown for both T1 and T2), for a total of 12 possible T1-T2 combinations, excluding the target with all the features (top left in the inset in Figure 2), which can only be

presented alone (in single target trials).

Distractor stimuli consisted of capital letters, presented in 52-point, bold Courier New font. They were drawn randomly without replacement from the full alphabet for each trial. To avoid confusion with the targets, the letters O and X were removed from the distractor set. The fixation cross consisted of a small plus sign (“+”).

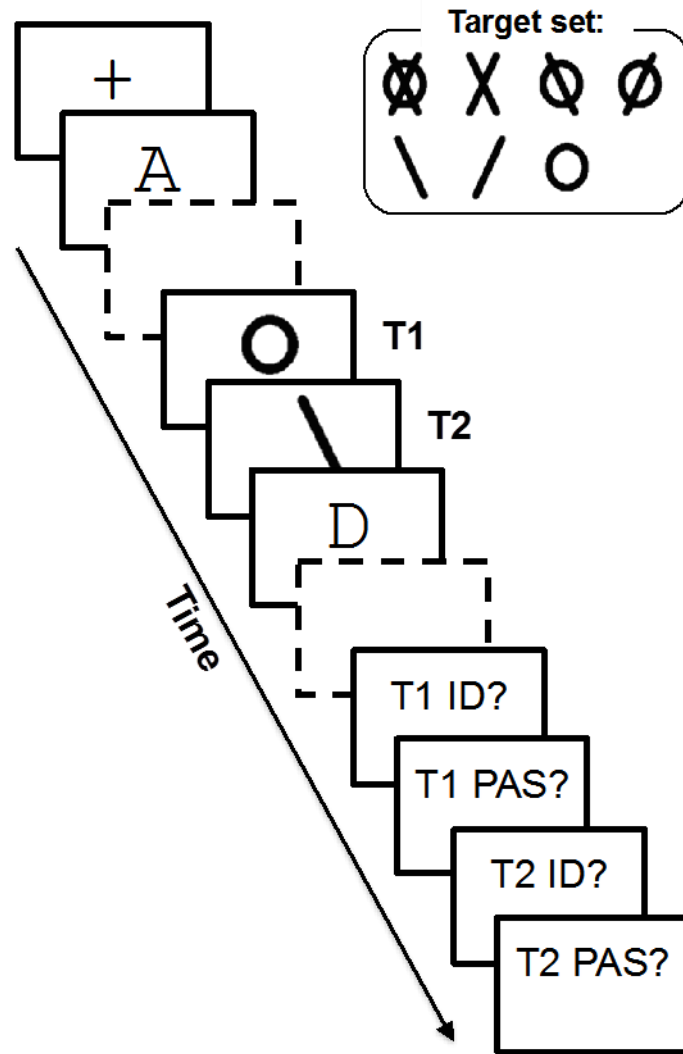

Figure 2. The experimental procedure. Dashed frames represent sequences of un-depicted distractors. At the end of each visual stream (trial), the participants had to report the identity of the perceived targets and their related experience was assessed with a modified version of the PAS scale. The box in the upper right corner shows the seven possible target symbols.

The four points of the original PAS from Overgaard et al. (2006) were formatted to fit our experiment. In particular, the PAS usually refers to a single-stimulus presentation, whereas in our experiment multiple stimuli were presented in each trial. So, we replaced all the references to “the stimulus” presented in the original PAS with a more specific reference to “the target”

previously reported. Our PAS version was as follows:

- 1. No experience.** No impression of the target is experienced. The answer is experienced as mere guessing.
- 2. Fleeting experience.** A feeling that the target was present, even though the target cannot be specified any further.
- 3. Almost clear experience.** Feeling of having seen the target, but not being sure about its identity.
- 4. Clear experience.** Non-ambiguous experience of the target.

2.3. Procedure

Each trial started with the presentation of the fixation cross for 200 ms after 100 ms of a blank screen with a grey background. Then the RSVP sequence of 15 stimuli started. Each stimulus was presented for 70 ms and followed by a 10 ms blank screen (80 ms SOA). On most trials, two of these stimuli were targets (i.e., T1 and T2), while the others were distractors. Targets were depicted in blue, while distractors were in black. T1 appeared as either the 5th or the 7th item in the stream and T2 followed T1 with 0, 2, or 7 distractors in-between (lag 1, 3, or 8). There was no T2 on a small portion of trials (5.2%), in which it was replaced with a distractor. These trials were excluded from analysis. The participants' task was to identify the targets at the end of the stream, after a 100 ms blank delay, by entering the identity of T1 and then that of T2. Participants entered the target identity by pressing one out of seven keys on a computer keyboard. Each key was associated with a single possible identity as indicated by a label applied on it. Participants had to mandatorily report T1 but they could skip the report of T2 by pressing the spacebar, if they saw only one target in the stream. Participants were encouraged to guess in case of doubt.

After reporting each target, participants had to rate their subjective experience of that target, by pressing a key from 1 to 4 corresponding to the points of the PAS scale, which were displayed on the screen with the corresponding labels.

The experiment included a total of 608 experimental trials (12 possible T1-T2 combinations X 3 lags X 16 trials for each combination + 32 single-target trials) randomized in two blocks of 304 trials. A short practice block including 20 trials, which was also excluded from analysis, preceded the experimental trials. The experimental session lasted for about 60 minutes.

2.4. Experimental design and statistical analyses

Analyses were performed on T1 and T2|T1 accuracy as well as on the associated mean PAS scores. For accuracy, we scored differently the identity of the report, i.e. the matching between the reported identity and the presented targets, and the order of the report, i.e. the correct sequence in which

targets have been presented. Thus we can have a target reported correctly in its identity but in the wrong order, e.g., a T1 reported as T2. By combining all the reporting conditions, we can have both targets reported correctly in identity and order, both targets reported correctly in identity but in the wrong order, only one target reported correctly in identity but necessarily in order, or both targets reported incorrectly in identity and order. A special condition is the report of an integrated percept: we scored a response as integration if participants reported the presence of only one target and the reported identity was equal to the combination of the two targets presented.

As we obtained a different number of trials per condition for each participant, as well as participants who reported no integrated response at all, we used linear-mixed effects models (Bates, Maechler, & Bolker, 2012) instead of the usual ANOVAs. This is because they compensate for trial number fluctuations and are more robust for quasi-experimental designs, so they can deal better with unequal numbers of cases. First, analyses were conducted with the dependent variables of the report accuracy of target identity or of both target identities and order, assessing the contribution of the fixed effects of lag and of report type. Then, we assessed the contribution of the fixed effects of both lag and of the type of error report (reversal vs. integration) on the dependent variable of the relative frequency of reversals and integrations. We also assessed the contribution of the fixed effects of relative PAS score on the report accuracy as dependent variable and the contribution of the fixed effects of trial report type (see next Section for details) on the PAS score related to the first or to the second target reported as dependent variables. Lastly, we assessed the contribution of the fixed effects of the correctness of the second target reported on the PAS score related to the first target reported, included as dependent variable. As random effects, participant and trial repetition random slopes were included in all the models. For each fixed effect, we will report estimated coefficients and standard errors, and the associated *t*-value. As suggested by Bates et al. (2012), *p*-values were obtained where possible by likelihood-ratio tests of the full model against the model without the effect in question.

3. Results

3.1. Accuracy data

As a first analysis, we tested the main and interaction effects of Lag and report type (identity only, or identity and order) on the mean accuracy of T1 and on the mean accuracy of T2|T1 (Figure 3, left panel). For the T1 accuracy, the analysis revealed that both the Lag ($\beta = 0.015$, $SE = 0.0035$, $t = 4.42$, $\chi^2(1) = 39.91$, $p < .001$) and the report type ($\beta = -0.353$, $SE = 0.008$, $t = -40.44$, $\chi^2(1) = 1505.4$, $p < .001$) affected the T1 accuracy. Also the interaction between the two fixed effects influenced T1 accuracy significantly ($\beta = 0.037$, $SE = 0.002$, $t = 21.01$, $\chi^2(1) = 437.63$, $p < .001$). In fact, we obtained considerably higher performance at Lag 1 when order was ignored (i.e. the T1i

curve). For the T2|T1 accuracy, the analysis revealed that this variable was not influenced by Lag ($\beta = -0.006$, $SE = 0.006$, $t = -0.859$, $\chi^2(1) = 0.801$, $p = .37$), but was by report type ($\beta = -0.24$, $SE = 0.01$, $t = -17.47$, $\chi^2(1) = 170.5$, $p < .001$), as well as by the interaction between these two factors ($\beta = 0.03$, $SE = 0.002$, $t = 12.38$, $\chi^2(1) = 152.35$, $p < .001$), due again to higher performance at Lag 1 when order was ignored.

After these first analyses on T1 and T2|T1 accuracy, we analysed the frequencies of reversal and integrated responses in the trials in which both the two target identities were reported correctly, with the relative frequencies of error in report as dependent variable. In particular, we assessed if lag has an effect on this dependent variable, that is, on the frequency of reversals and integrations. As shown in Figure 3, right panel, Lag did not affect the frequency of trials in which participants reported a reversal ($\beta = -0.005$, $SE = 0.003$, $t = -1.49$, $\chi^2(1) = 2.11$, $p = .11$) but it significantly affected the frequency of trials in which participants reported an integrated target ($\beta = -0.07$, $SE = 0.009$, $t = -8.1$, $\chi^2(1) = 31.59$, $p < .001$), causing a decrease in the frequency of integrated percepts as Lag increased.

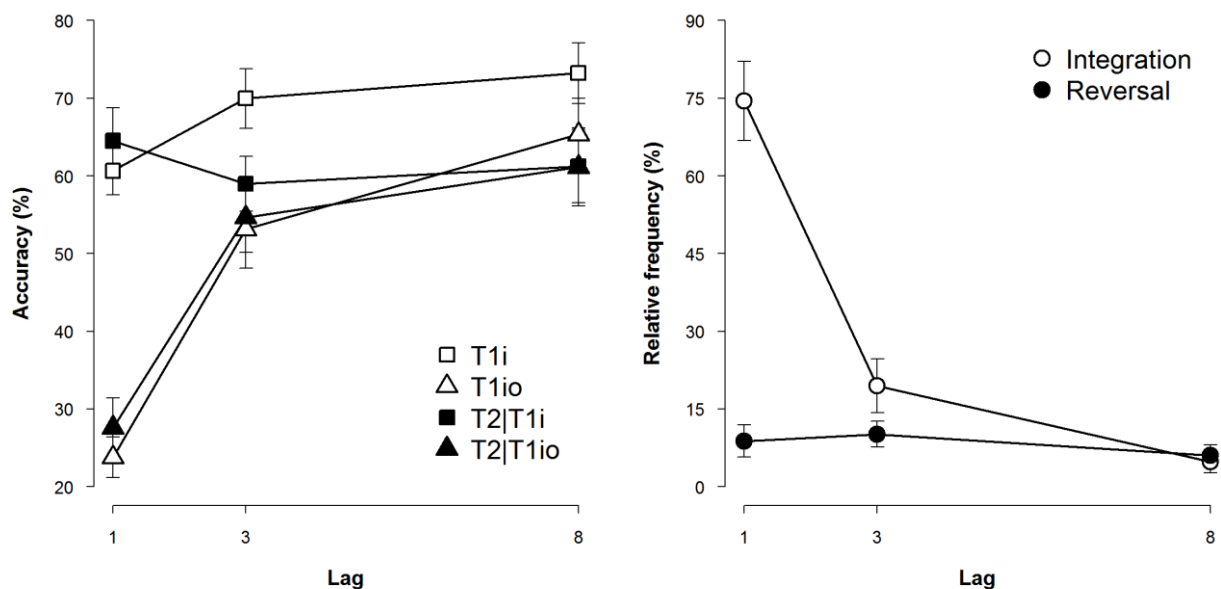

Figure 3. Left panel, average accuracy in different reporting conditions, identity only correct (i) or both identity and order correct (io), as a function of Lag, for T1 and T2|T1. Please note that in both integrations and reversals, identities of the two targets were considered as correctly reported. Right panel, average relative frequencies of integrations and reversals as function of Lag. Error bars display standard errors.

3.2. Perceptual awareness data

With regard to the PAS scores, we conducted a first analysis on the target accuracy related to the first (R1) and second (R2) response and with different reported perceptual experience. We collapsed

the accuracy data across lag for this analysis. This involved comparing for each dependent variable (accuracy on R1 and accuracy on R2), a model with the fixed effect of the reported PAS score corresponding to R1 and R2, with a model without this fixed effect (Fig. 4). The first PAS score reported varied with the R1 accuracy ($\beta = 9.99$, $SE = 0.49$, $t = 20.5$, $\chi^2(1) = 411.79$, $p < .001$), with accuracy increasing as the PAS score increased. The same effect was present for the R2 accuracy, which varied similarly with the PAS score reported on R2 ($\beta = 10.11$, $SE = 0.52$, $t = 19.38$, $\chi^2(1) = 362.18$, $p < .001$).

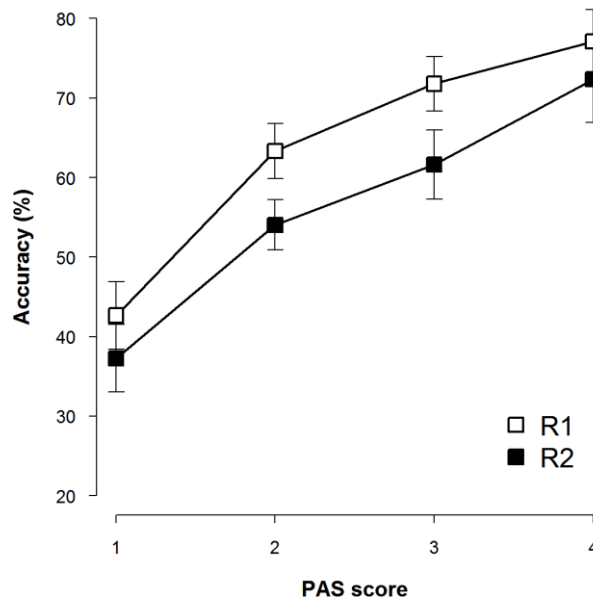

Figure 4. Average accuracy as a function of the PAS score for both the first and the second target reported. Error bars display standard errors.

As explained in the Introduction, we were mainly interested in assessing if reversal and integration events lead to clearer or poorer perceptual experiences with respect to other reporting conditions. To this end, we compared the reported perceptual awareness in those trials (reversal, R, and integration, I) with that reported in three other conditions: i) with both targets' identity and order reported wrongly (both wrong, BW); ii) with only one target identity reported correctly (single correct, SC); and iii) with both targets' identity and order reported correctly (both correct, BC). Table 1 summarizes the average number of different reports we found in our data. In particular, we averaged the PAS score associated with R1 and R2 in all these conditions, with the exception of the integration, in which only the PAS score of R1 was considered (for which, by definition, no R2 was given). Again, we collapsed the data across lag for this analysis. Figure 5 reports the average values computed for each condition. Please note that, for this as well as for the following analyses, the match between box-plots in figures and reported statistics is not perfect. This is because a mixed-effects analysis contains trial-level regressors (fixed effects) and

participant-level regressors (random effects), and the inferred coefficients are influenced by both these levels. For consistency with previous publications, figures show participant-level distributions, while reporting means computed over all of the trials (as dots inside the boxes).

TABLE 1. Average data on the number of different reports.

Condition	Mean	SD	Max	Min
Single Correct	161.79	66.47	302	78
Both Correct	145.04	110.37	410	18
Integration	75.54	63.06	242	0
Reversal	19.88	12.64	52	4
Both Wrong	66.71	58.91	254	9

To assess if the PAS score associated with the I and R trials was different, for each of the other conditions, we computed a full model including the PAS score obtained in that “other” condition and in the I and R conditions, which together comprise the dependent variable. Then, as independent variables we included the fixed effect of I and R conditions, and the random effects of participants and trial repetitions. In this model, the “other” condition gives the intercept. Then, we compared each full model with the other two models in which we removed the effects of I and then R, respectively. In this manner, we could estimate if I and R events led to different or similar PAS scores with respect to the other considered conditions, by analysing the way in which the I and R conditions affected the model fitting. Finally, we contrasted directly I and R conditions by comparing a full model with both conditions with a model without one of the two. We summarized these analyses in Table 2, where (significance test) p-values of effects discussed below are shown.

The analysis revealed that in both I and R trials, participants reported higher PAS scores than in BW trials ($\beta=0.58$ and $\beta=0.2$, respectively). Instead, with reference to the SC trials, participants reported significantly higher PAS scores in I trials ($\beta=0.42$) but similar PAS scores in R trials ($\beta=0.04$), and with reference to the BC trials, participants reported significantly lower PAS scores in R trials ($\beta=-0.43$) but similar PAS scores in I trials ($\beta=-0.005$). In summary, this analysis showed that I and R trials, in which at least targets’ identity was correctly reported, led to a clearer perceptual experience than the worst case, i.e., BW trials, in which the identity of both targets was wrong. Instead, the PAS score associated with the trials in which the identity of only one target was correct was similar to the PAS score associated with R trials and lower than that associated with I trials. Lastly, the PAS score associated with trials in which the identity and order of both targets

were reported correctly (BC) was higher than the PAS score associated with the R trials but similar to that associated with the I trials. Consistent with the results reported so far, comparing directly the PAS score associated with I and R trials revealed significantly higher PAS score in I trials ($\beta=0.37$).

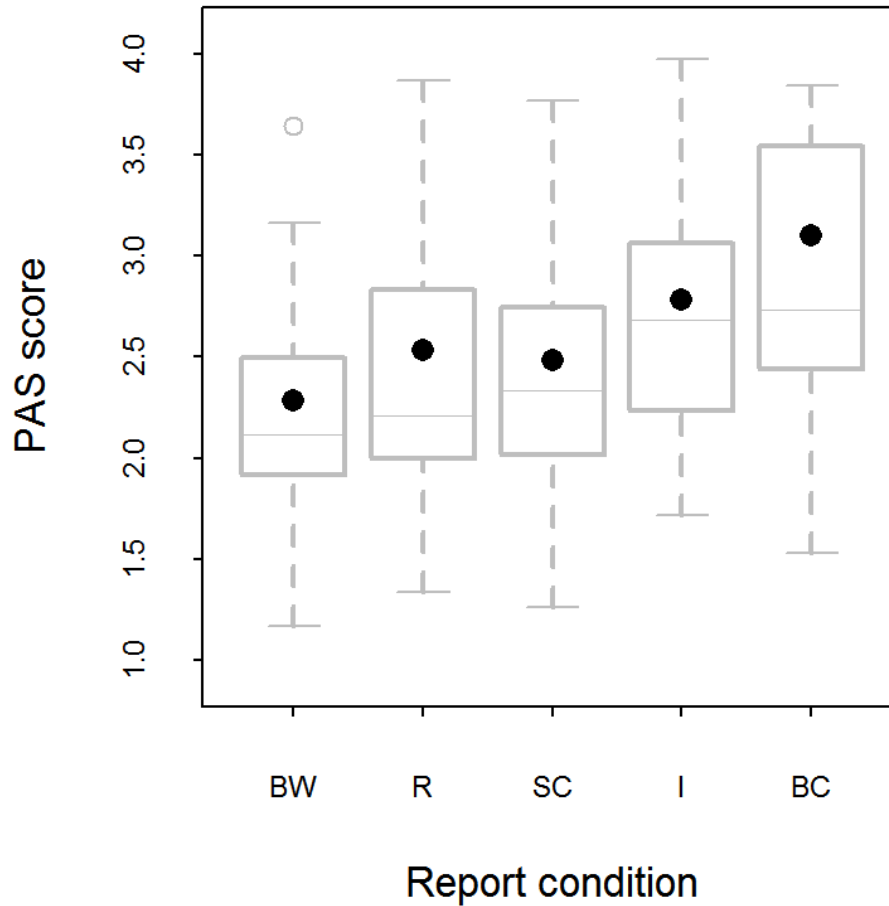

Figure 5. Box plot of PAS scores in different report conditions. The black dots represent mean values. The grey dots represent outlier values. BW=both wrong; R=reversal; SC=single correct; I=integration; BC=both correct.

TABLE 2. Mixed effect model results on average PAS score.

Condition included in the model	Fixed effect	β	SE	t	χ^2
Single Correct	<i>Intercept</i>	2.43	0.12	20.94	
	Integration	0.42	0.06	6.68	21.79**
	Reversal	0.04	0.05	0.85	0.42
Both Correct	<i>Intercept</i>	2.88	0.13	21.51	
	Integration	-0.005	0.06	-0.072	0.005
	Reversal	-0.43	0.08	-5.4	19.05**
Both wrong	<i>Intercept</i>	2.26	0.11	20.06	
	Integration	0.58	0.08	6.92	22.57**
	Reversal	0.20	0.06	3.39	8.44*
Only Reversal	<i>Intercept</i>	2.46	0.14	17.81	
	Integration	0.37	0.10	3.67	9.64*

Note. * $p < .01$, ** $p < .001$

To assess the influence of Lag on the effects found, we conducted three further analyses. We simply applied the same pattern of analysis previously reported, but we included only the trials of a single lag: 1, 3, and 8 respectively (Fig. 6). We summarized all the results of these analyses in Table 3, including (significance test) p-values. With respect to Lag 1 (see Fig. 6, left), the PAS score in I trials was higher than that in all other conditions ($\beta=0.65$, $\beta=0.39$, and $\beta=0.78$ for the comparison with SC, BC, and BW trials respectively), whereas in R trials the PAS score was lower than that associated with BC trials ($\beta=-0.26$) and similar to that associated with SC ($\beta=0.03$) and BW ($\beta=0.08$) trials. With respect to Lag 3 (see Fig. 6, middle), the PAS score associated with the SC trials was lower than that associated with I trials ($\beta=0.24$) but similar to that associated with R trials ($\beta=0.06$), and a reverse pattern of results applies to the BC trials, with PAS score similar to the I and higher than that in the R trials ($\beta=-0.08$ and $\beta=-0.3$, respectively for I and R trials). Then, the PAS associated with BW trials was lower than that associated with both I and R trials ($\beta=0.41$ and $\beta=0.28$, respectively). Finally, with respect to Lag 8 (see Fig. 6, right) the PAS score associated with I and R trials was lower than that associated with BC trials ($\beta=0.5$ and $\beta=-0.18$), whereas PAS for I trials was similar to both SC and BW trials ($\beta=-0.06$ and $\beta=0.04$) and PAS for R trials was higher than both SC and BW trials ($\beta=0.2$ and $\beta=0.25$). Again, we compared directly the PAS score associated with I and R trials, and we found that it was higher in I trials at Lag 1 ($\beta=0.53$) but

similar at Lag 3 ($\beta=0.17$) and Lag 8 ($\beta=-0.25$).

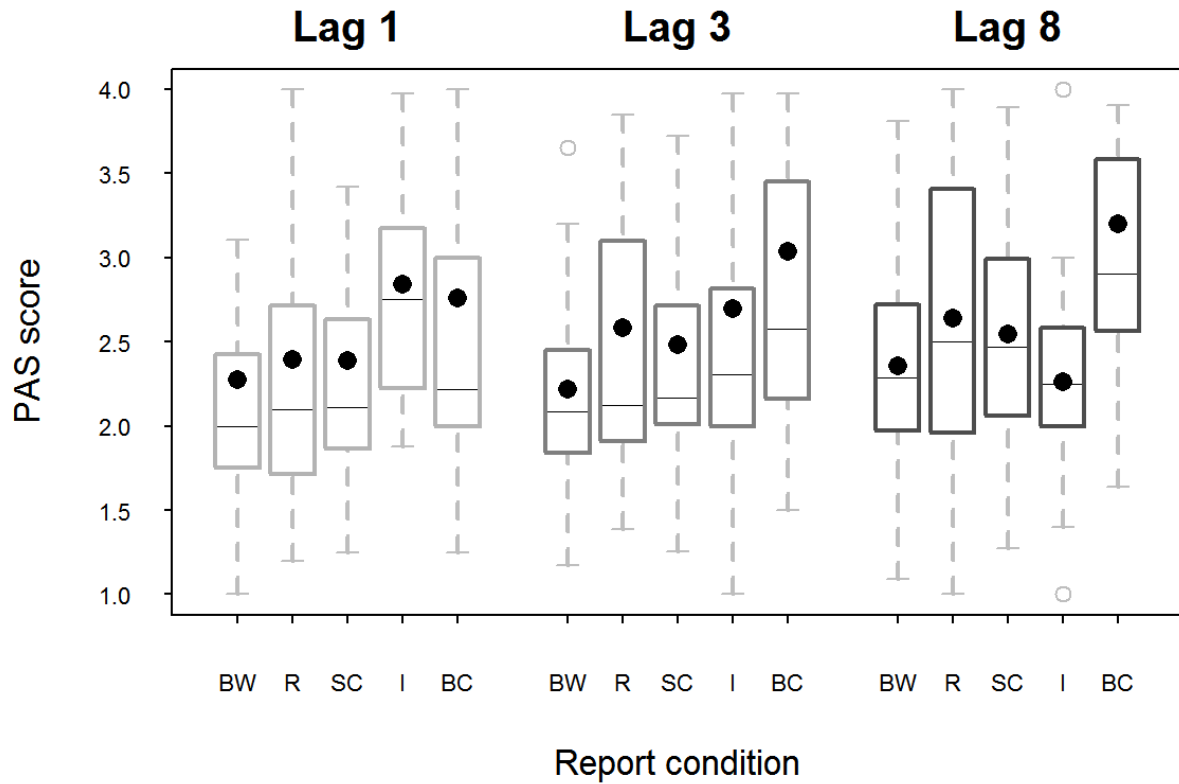

Figure 6. Box plot of PAS score in different report conditions, divided by Lag. The black dots represent the mean values. The grey dots represent outlier values. BW=both wrong; R=reversal; SC=single correct; I=integration; BC=both correct.

TABLE 3. Mixed effect model results on average PAS score for each Lag.

Condition included in the model	Fixed effect	Lag 1		Lag 3		Lag 8	
		β (SE)	<i>t</i>	β (SE)	<i>t</i>	β (SE)	<i>t</i>
Single Correct	Intercept	2.26 (0.12)	19.33	2.42 (0.12)	20.09	2.55 (0.13)	19.88
	Integration	0.65 (0.1)	6.44**	0.24 (0.07)	3.41*	-0.06 (0.11)	-0.59
	Reversal	0.03 (0.06)	0.57	0.06 (0.07)	0.91	0.2 (0.07)	2.89**
Both Correct	Intercept	2.54 (0.13)	19.33	2.8 (0.14)	19.63	2.97 (0.13)	22.38
	Integration	0.39 (0.1)	3.97**	-0.08 (0.09)	-0.91	-0.5 (0.14)	-3.69**
	Reversal	-0.26 (0.08)	-3.32**	-0.3 (0.09)	-3.43*	-0.18 (0.06)	-3.03**
Both wrong	Intercept	2.14 (0.11)	19.97	2.21 (0.11)	19.21	2.42 (0.14)	17.47
	Integration	0.78 (0.13)	5.87**	0.41 (0.07)	5.49**	0.04 (0.12)	0.3
	Reversal	0.08 (0.06)	1.36	0.28 (0.07)	3.72**	0.25 (0.09)	2.83*
Only Reversal	Intercept	2.31 (0.14)	16.99	2.51 (0.15)	16.23	2.67 (0.18)	14.93
	Integration	0.53 (0.16)	3.36**	0.17 (0.1)	1.66	-0.25 (0.16)	-1.5

Note. * $p < 0.05$, ** $p < 0.01$

Finally, we analysed the contribution of R2 accuracy to the PAS score reported for R1 (Fig. 7). In particular, we computed a mixed effects model on the PAS score related to R1 (which gives the dependent variable), with the random effect of participants and the fixed effect of R2 correctness. We repeated this analysis for each Lag. We found that the R1-related PAS score was significantly affected by the correctness of R2 report, with higher PAS score for R1 when R2 report was correct at Lag 1, $\beta=0.15$, $SE=0.06$, $t=2.6$, $p<.05$, at Lag 3, $\beta=0.26$, $SE=0.05$, $t=4.72$, $p<.001$, as well as at Lag 8, $\beta=0.25$, $SE=0.04$, $t=6.79$, $p<.001$. Please note that, even if the effect was present for all the three lags, it was more pronounced at Lag 3 and 8, $\beta=0.26$ and $\beta=0.25$ respectively, than at Lag 1, $\beta=0.15$,

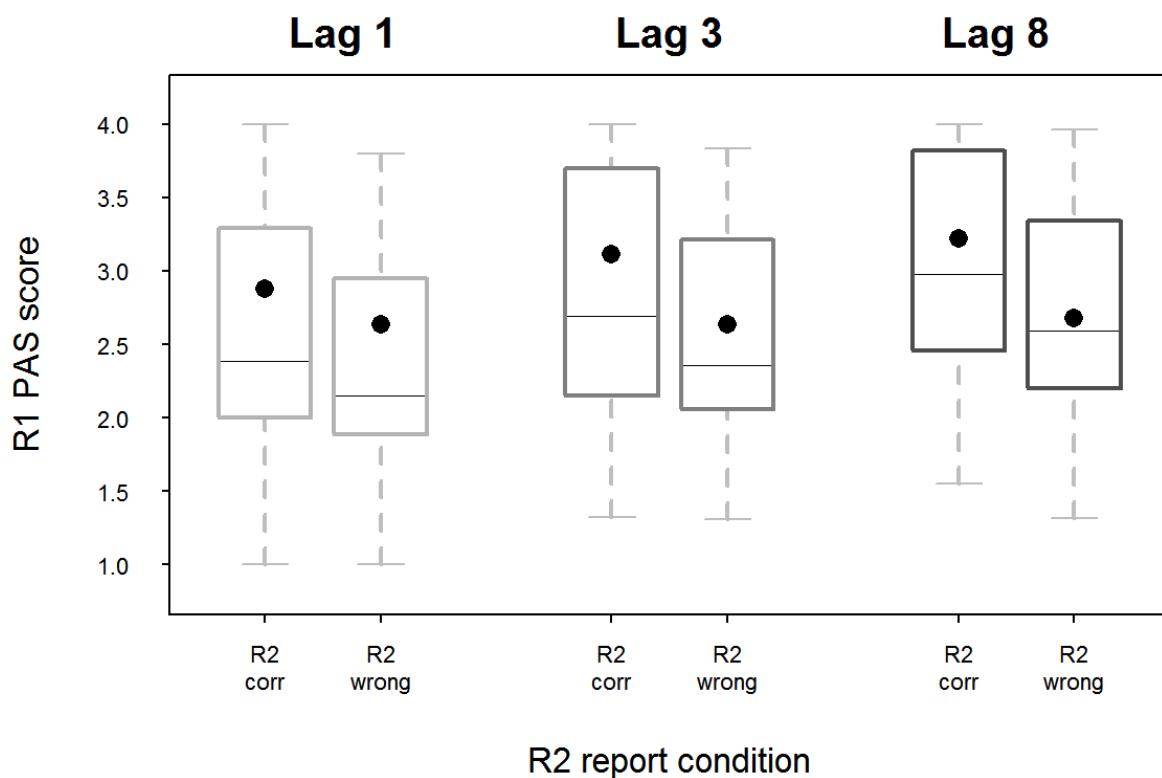

Figure 7. Box plot of PAS score reported on R1 in different R2 report conditions, separated by Lag. The black dots represent the mean values.

4. Discussion

In this paper, we investigated how different kinds of target report conditions influenced the perceptual awareness of two consecutive targets embedded in a stream of stimuli. To this end, we asked participants to report both the identity of the two targets and the perceptual awareness associated with each target on a modified version of the PAS scale (Overgaard et al., 2006). To allow the report of integrated percepts that included all features of both the first and the second target, we used stimuli that could potentially be combined together to form a more complex one

(Akyürek et al., 2012). We found that participants often reported integrated percepts at Lag 1 and that the perceptual awareness associated with such integrated events was even higher than that associated with fully correct responses. On the contrary, when the two targets were reported in the wrong order (partial or complete reversals), the associated PAS score was at the level of that associated with the completely wrong responses. Overall, our results show that integrated percepts are experienced as a unique, clear perceptual event, whereas the reversals are experienced as confused or not clear, similar to cases in which an entirely wrong response was given.

This outcome supports the idea that temporal target integration not only requires comparatively low mental effort (Wolff et al., 2015), but also results in a clear representation, close to (and at Lag 1 in fact stronger than) that of a pair of correctly perceived and ordered individual targets. It is thus unlikely that the quality of the featural representations is negatively affected by integration, as might be expected if mutual target competition would have become more intense as a consequence thereof. Instead, the idea that integration and competition may be the extremes of a perceptual processing spectrum (Hommel & Akyürek, 2005) is more compatible with the present findings.

It may be noted also that the apparent absence of competition between targets in the present study was obtained with stimuli that do not necessarily match well together, or form a particularly coherent form (i.e., a Gestalt), such as have been used in some versions of the current task (cf. Experiment 1 of Akyürek et al., 2012). Spatial and/or featural Gestalt grouping effects were thus not needed to eliminate competition, pointing again towards the idea that temporal integration by itself afforded a coherent representation.

The observers were sensitive, at some level of processing, to the loss of temporal information associated with trials in which they incorrectly ordered the targets, and produced lower PAS scores in these cases. It is therefore interesting to note that a similar loss of order information during temporal integration (i.e., everything appears more or less simultaneous), was not experienced as equally unclear. To the observers, then, temporal confusion was only a factor between events; between separate T1s and T2s, not within events. When integration occurs, the impression of having seen a single stimulus is thus relatively strong. When a reversal occurs, it is conceivable that effects of prior entry play a role. Prior entry is the principle that attentional facilitation of a stimulus (in this case T2) causes it to be more strongly activated, and thereby to be perceived as having come first (Olivers, Hilkenmeier, & Scharlau, 2011; Shore, Spence, & Klein, 2001). The current data suggest that observers do experience some uncertainty when this loss of order information occurs.

Nevertheless, the relationship between our findings and measures of metacognitive sensitivity, bias or efficiency (Fleming and Lau, 2014), is not completely clear. In particular,

measures such as type 2 area under the ROC curve and metacognitive d' , are not directly applicable to the questions we are considering here. Such measures of metacognition consider how accurately confidence judgements reflect correct versus incorrect reporting. The comparisons we are making are not though typically about correct versus incorrect reporting. For example, a key comparison for us is between Integrations and Reversals; these are both incorrect responses, and thus their comparison does not naturally fit into the metacognitive sensitivity framework. Accordingly, the relationship between our findings and the classic measures of metacognition awaits further consideration.

More concretely, in terms of the STST framework (Bowman & Wyble, 2007; Wyble, Bowman, & Nieuwenstein, 2009), it could be argued that integration errors are characteristic of the “Single episode” pattern of token to type binding shown in figure 1, panel D. That is, the two types bind exclusively into a single token, with no order information represented. Under typical AB task contingencies, where an integrated percept is not a possible stimulus, the STST model assumes that this case would yield a 50-50 guess at the order of types at report. This, for example, is the readout employed in (Bowman & Wyble, 2007) to model letters-in-digits tasks. However, in the experiment reported here, an integrated percept is a possible stimulus, and thus, we propose, would be reported as such in preference to an order guess. Additionally, STST would suggest that errors recorded as reversals in this paper, would be generated from a combination of “Pure order” and “Impure order” errors, c.f. Figure 1 panel B and panel C, respectively. In the former of these, only the second target gets bound to token one, and only the first to token two. Consequently, the “Pure order” case could be considered full prior entry, while “Impure order” might be considered a partial prior entry. In particular, in the “Impure order” error case, the bindings of one or more targets is “smeared across” two tokens. As previously stated, dependent upon the relative activation strengths of T1 and T2, both “Pure” and “Impure” order error outcomes can arise from STST.

Importantly, it has been argued that association of episodic contexts (in our setting, tokens) is an important foundation for metacognitive reflection (Pasquali, Timmermans, & Cleeremans, 2010). That is, the ability to reflect on our own thoughts, which has been argued to be central to our capacity to subjectively experience (c.f. Higher Order Theories of Thought; Lau & Rosenthal, 2011), requires episodic structuring of experiences, to know when, where, and in most general terms, in what context those experiences occurred. Just such introspection is at the heart of a subjective visibility judgement, suggesting that something like a bound token may serve as a unit of perceptual experience. Thus, it might be argued that the unambiguous association of types (which are STSTs representations of experiences) to tokens would yield high subjective visibility, while ambiguous bindings would yield low subjective visibility.

From this standpoint, STST would explain our key finding by arguing that, all else equal,

the “Perfect performance” (Figure 1A), “Pure order error” (Figure 1B) and “Single episode” (Figure 1D) outcomes would all yield relatively high subjective visibility, since type-token associations are unambiguous. However, the “Impure order error” (Figure 1C) outcome would yield a low subjective visibility. Thus, the lower visibility for Reversals may be attributed to the prevalence of “Impure order error” outcomes, that is, the association to a type may be “smeared” across multiple tokens.

Conceptually, this STST interpretation is consistent with the notion that the role of tokens is to associate an episodic property to each *individual* item/ type, and when that individuation breaks down (as reflected by smearing across tokens) a subjectively anomalous experience is generated.

The STST model also fits well with our final analysis; see Figure 6, in which we showed that correct R2 responses were associated with higher T1 PAS scores than incorrect R2 responses. This finding is suggestive of the *reciprocal relationship* between T1 bottom-up trace strength and the attentional blink (Bowman, Wyble, Chennu, & Craston, 2008). The reciprocal relationship states that stronger T1s, which should presumably elicit higher PAS scores, encode faster and thus delay T2 encoding less. As a result, when T1 is strong, T2s encode more successfully and the blink is attenuated. This reciprocal relationship is in direct contrast to T1-T2 competition theories, such as, resource sharing (Shapiro, Schmitz, Martens, Hommel, & Schnitzler, 2006), interference theory (Shapiro, Raymond, & Arnell, 1997) and, indeed, the Global Workspace, as originally conceived (Dehaene et al., 2003). All of these would suggest a *proportional* relationship between T1 strength and the AB; that is, they suggest that a stronger T1 would suppress the T2 more. As discussed in (Bowman et al., 2008) and consistent with what is found here, typically in the literature a reciprocal relationship is observed.

Lastly, our results might also be interpreted as suggesting that integration and reversal of targets are different processes happening at different processing stages. In fact, the STST model and most of the other computational models of the attentional blink (and of its relation to conscious experience) included two or more stages of computation, with the early ones dedicated to feature extraction and target identification, and the later to target memorization and conscious access to target information (Bowman & Wyble, 2007; Chun & Potter, 1995; Dehaene et al., 2003; Raffone & Pantani, 2010; Raffone, Srinivasan, & van Leeuwen, 2014; Simione et al., 2012; Wyble et al., 2009). In such models, in the early levels, all the stimuli are processed in parallel, whereas in the later levels some competitive or time-locked mechanisms are implemented. In light of our results, it might be argued that integration occurs in the early processing stages, leading to the formation of only one integrated representation that results in a clearer and sharper experience of such a temporal event, and also a single combined representation entering a token. It thereby seems that illusions of

integration in RSVP are subjectively impenetrable; they cannot be distinguished from (Both Correct) non-illusory percepts on the basis of assessment of the strength of conscious experience. By contrast, target reversal should occur at later stages of processing, with the formation of two distinct but wrongly ordered memory representations, with the consequence that the two events are experienced as most confused or “entangled”.

5. References

- Akyürek, E. G., Eshuis, S., Nieuwenstein, M. R., Saija, J. D., Baskent, D., & Hommel, B. (2012). Temporal Target Integration Underlies Performance at Lag 1 in the Attentional Blink. *Journal of Experimental Psychology. Human Perception and Performance*, 38(6), 1–1468–1464. doi:10.1037/a0027610
- Baars, B. J., & Franklin, S. (2003). How conscious experience and working memory interact. *Trends in Cognitive Sciences*, 7(4), 166–172. doi:10.1016/S1364-6613(03)00056-1
- Bates, D. M., Maechler, M., & Bolker, B. (2012). lme4: Linear mixed-effects models using S4 classes. R package version 0.999999-0.
- Block, N. (2007). Consciousness, accessibility, and the mesh between psychology and neuroscience. *The Behavioral and Brain Sciences*, 30(5-6), 481–99; discussion 499–548. doi:10.1017/S0140525X07002786
- Bowman, H., & Wyble, B. (2007). The simultaneous type, serial token model of temporal attention and working memory. *Psychological Review*, 114(1), 38–70. doi:10.1037/0033-295X.114.1.38
- Bowman, H., Wyble, B., Chennu, S., & Craston, P. (2008). A reciprocal relationship between bottom-up trace strength and the attentional blink bottleneck: Relating the LC–NE and ST2 models. *Brain Research*, 1202, 25–42. doi:10.1016/j.brainres.2007.06.035
- Broadbent, D. E., & Broadbent, M. H. (1987). From detection to identification: response to multiple targets in rapid serial visual presentation. *Perception & Psychophysics*, 42(2), 105–13.
- Chun, M. M., & Potter, M. C. (1995). A two-stage model for multiple target detection in rapid serial visual presentation. *Journal of Experimental Psychology. Human Perception and Performance*, 21(1), 109–27.
- Craston, P., Wyble, B., Chennu, S., & Bowman, H. (2009). The attentional blink reveals serial working memory encoding: evidence from virtual and human event-related potentials. *Journal of Cognitive Neuroscience*, 21(3), 550–66. doi:10.1162/jocn.2009.21036
- Dehaene, S., Sergent, C., & Changeux, J.-P. (2003). A neuronal network model linking subjective

reports and objective physiological data during conscious perception. *Proceedings of the National Academy of Sciences of the United States of America*, 100(14), 8520–5.
doi:10.1073/pnas.1332574100

Fleming, S. M., & Lau, H. C. (2014). How to measure metacognition. *Frontiers in Human Neuroscience*, 8(July), 443. <https://doi.org/10.3389/fnhum.2014.00443>

Hommel, B., & Akyürek, E. G. (2005). Lag-1 sparing in the attentional blink: Benefits and costs of integrating two events into a single episode. *The Quarterly Journal of Experimental Psychology Section A*, 58(8), 1415–1433. doi:10.1080/02724980443000647

Lamme, V. A. F. (2006). Towards a true neural stance on consciousness. *Trends in Cognitive Sciences*, 10(11), 494–501. doi:10.1016/j.tics.2006.09.001

Lau, H., & Rosenthal, D. (2011). Empirical support for higher-order theories of conscious awareness. *Trends in Cognitive Sciences*, 15(8), 365–73. doi:10.1016/j.tics.2011.05.009

Nieuwenhuis, S., & de Kleijn, R. (2011). Consciousness of targets during the attentional blink: a gradual or all-or-none dimension? *Attention, Perception & Psychophysics*, 73(2), 364–73. doi:10.3758/s13414-010-0026-1

Olivers, C. N. L., Hilkenmeier, F., & Scharlau, I. (2011). Prior entry explains order reversals in the attentional blink. *Attention, Perception & Psychophysics*, 73(1), 53–67. doi:10.3758/s13414-010-0004-7

Overgaard, M., Rote, J., Mouridsen, K., & Ramsøy, T. Z. (2006). Is conscious perception gradual or dichotomous? A comparison of report methodologies during a visual task. *Consciousness and Cognition*, 15(4), 700–8. doi:10.1016/j.concog.2006.04.002

Pasquali, A., Timmermans, B., & Cleeremans, A. (2010). Know thyself: metacognitive networks and measures of consciousness. *Cognition*, 117(2), 182–90. doi:10.1016/j.cognition.2010.08.010

Pincham, H. L., Bowman, H., & Szucs, D. (2016). The experiential blink: Mapping the cost of working memory encoding onto conscious perception in the attentional blink. *Cortex*, 81, 35–49.

Raffone, A., & Pantani, M. (2010). A global workspace model for phenomenal and access consciousness. *Consciousness and Cognition*, 19(2), 580–96. doi:10.1016/j.concog.2010.03.013

Raffone, A., Srinivasan, N., & van Leeuwen, C. (2014). The interplay of attention and consciousness in visual search, attentional blink and working memory consolidation.

Philosophical Transactions of the Royal Society of London. Series B, Biological Sciences, 369(1641), 20130215.

- Raymond, J. E., Shapiro, K. L., & Arnell, K. M. (1992). Temporary suppression of visual processing in an RSVP task: an attentional blink? *Journal of Experimental Psychology: Human Perception and Performance*, 18(3), 849–60.
- Sergent, C., & Dehaene, S. (2004). Is Consciousness a Gradual Phenomenon? *Psychological Science*, 15(11), 720–728.
- Shapiro, K. L., Raymond, J. E., & Arnell, K. M. (1997). The attentional blink. *Trends in Cognitive Sciences*, 1(8), 291–6. doi:10.1016/S1364-6613(97)01094-2
- Shapiro, K., Schmitz, F., Martens, S., Hommel, B., & Schnitzler, A. (2006). Resource sharing in the attentional blink. *Neuroreport*, 17(2), 163–6.
- Shore, D. I., Spence, C., & Klein, R. M. (2001). Visual prior entry. *Psychological Science*, 12(3), 205–12.
- Simione, L., Raffone, A., Wolters, G., Salmas, P., Nakatani, C., Belardinelli, M. O., & van Leeuwen, C. (2012). ViSA: A Neurodynamic Model for Visuo-Spatial Working Memory, Attentional Blink, and Conscious Access. *Psychological Review*, 119(4), 745–69. doi:10.1037/a0029345
- Visser, T. A. W., Bischof, W. F., & Di Lollo, V. (1999). Attentional switching in spatial and nonspatial domains: Evidence from the attentional blink. *Psychological Bulletin*, 125(4), 458–469. doi:10.1037/0033-2909.125.4.458
- Wolff, M. J., Scholz, S., Akyürek, E. G., & van Rijn, H. (2015). Two visual targets for the price of one? Pupil dilation shows reduced mental effort through temporal integration. *Psychonomic Bulletin & Review*, 22(1), 251–7. doi:10.3758/s13423-014-0667-5
- Wyble, B., Bowman, H., & Nieuwenstein, M. R. (2009). The attentional blink provides episodic distinctiveness: Sparing at a cost. *Journal of Experimental Psychology: Human Perception and Performance*, 35(3), 787–807. doi:10.1037/a0013902