

A mixed 1-phase and 3-phase vehicle charging system from AC rail traction power network

Hajian Foroushani, Masood; Tricoli, Pietro

DOI:

[10.1109/CPE-POWERENG50821.2021.9501199](https://doi.org/10.1109/CPE-POWERENG50821.2021.9501199)

License:

Other (please specify with Rights Statement)

Document Version

Peer reviewed version

Citation for published version (Harvard):

Hajian Foroushani, M & Tricoli, P 2021, A mixed 1-phase and 3-phase vehicle charging system from AC rail traction power network. in *2021 IEEE 15th International Conference on Compatibility, Power Electronics and Power Engineering (CPE-POWERENG)*., 9501199, Compatibility in Power Electronics (CPE), Institute of Electrical and Electronics Engineers (IEEE), pp. 1-6, IEEE CPE-POWERENG 2021, Florence, Italy, 14/07/21. <https://doi.org/10.1109/CPE-POWERENG50821.2021.9501199>

[Link to publication on Research at Birmingham portal](#)

Publisher Rights Statement:

© 2021 IEEE. Personal use of this material is permitted. Permission from IEEE must be obtained for all other uses, in any current or future media, including reprinting/republishing this material for advertising or promotional purposes, creating new collective works, for resale or redistribution to servers or lists, or reuse of any copyrighted component of this work in other works.

M. Hajian and P. Tricoli, "A Mixed 1-phase and 3-phase Vehicle Charging System from AC Rail Traction Power Network," 2021 IEEE 15th International Conference on Compatibility, Power Electronics and Power Engineering (CPE-POWERENG), 2021, pp. 1-6, doi: 10.1109/CPE-POWERENG50821.2021.9501199.

General rights

Unless a licence is specified above, all rights (including copyright and moral rights) in this document are retained by the authors and/or the copyright holders. The express permission of the copyright holder must be obtained for any use of this material other than for purposes permitted by law.

- Users may freely distribute the URL that is used to identify this publication.
- Users may download and/or print one copy of the publication from the University of Birmingham research portal for the purpose of private study or non-commercial research.
- User may use extracts from the document in line with the concept of 'fair dealing' under the Copyright, Designs and Patents Act 1988 (?)
- Users may not further distribute the material nor use it for the purposes of commercial gain.

Where a licence is displayed above, please note the terms and conditions of the licence govern your use of this document.

When citing, please reference the published version.

Take down policy

While the University of Birmingham exercises care and attention in making items available there are rare occasions when an item has been uploaded in error or has been deemed to be commercially or otherwise sensitive.

If you believe that this is the case for this document, please contact UBIRA@lists.bham.ac.uk providing details and we will remove access to the work immediately and investigate.

A Mixed 1-phase and 3-phase Vehicle Charging System from AC Rail Traction Power Network

Masood Hajian

*Department of Electronic, Electrical,
and Systems Engineering
University of Birmingham
Birmingham, United Kingdom
m.hajian@bham.ac.uk*

Pietro Tricoli

*Department of Electronic, Electrical,
and Systems Engineering
University of Birmingham
Birmingham, United Kingdom
p.tricoli@bham.ac.uk*

Abstract— Electric vehicle (EV) charging will become a major challenge for distribution networks stability due to fast increasing number. Several methods have been discussed to avoid adverse impacts of EVs on power distribution grids. This paper presents a novel idea of charging EVs from surplus capacity available at AC rail traction substations. These feeders are normally designed for much higher capacity than is required to ensure continuous trains operation even in the event of a substation power outage. Separate single-phase and three-phase EV charging grids are proposed in which single-phase chargers are fed by single-phase transformers directly connected to traction supply, while three-phase chargers are fed by a power electronic converter involving a back to back connection of a single-phase and a three-phase voltage source converter (VSC). This results in reduced capital and running costs. A backup battery is also used to supply the chargers when traction supply does not have capacity to fully feed the EVs' charging demand. Therefore, an energy management system is required to ensure that the converter feeds the single-phase chargers while maintaining the power quality on the three-phase grid. The system is modelled in MATLAB/Simulink and simulation results are presented to confirm the method effectiveness.

Keywords— *Railway traction supply, Voltage Source Converter (VSC), Battery Charger, Electric Vehicle (EV), Energy Management System (EMS).*

I. INTRODUCTION

Application of plug-in hybrid electric vehicles (PHEVs) and EVs is one of the most viable solutions to address air pollution challenge in large cities. It is known that 25 – 40% of air pollution is directly related to use of traditional vehicles equipped with combustion engines [1]. Additionally, fossil-based resources employed for fuel production of combustion engines are not sustainable whereas EVs can be fueled directly from renewable and sustainable resources such as photovoltaic panels (PVs), fuel cells, or wind energy. It is envisaged that by 2050 EVs will take at least 50% of the vehicle manufacturing industry capacity [2].

Despite the above benefits, there are still challenges against widespread use of EVs. High capacity batteries are strongly needed to enable longer travels without recharging [2]. Currently a fully charged battery can travel for an average of 100 miles with a single charge which needs further improvement [3]. Controlled bi-directional charging techniques are also demanded to enable vehicle to grid (V2G) and vehicle to vehicle (V2V) power flow capability. This is of particular importance when high density of EVs are used in a relatively small geographical area such as an isolated micro-grid where simultaneous uncontrolled charging can severely impact distribution grid voltage quality [3, 4].

Additionally, fast refueling is quite important to enable EVs competition to traditional combustion engines. Note that EV can be either designed with an on-board AC charger directly connected to the wall outlet, or to take DC power from an external battery charger. In both scenarios the input power is to be provided from an upstream AC source. So far, distribution grid has been mainly used to provide the required power for EV battery charging. However, this can severely impact voltage quality and implies huge capital expenditure for reinforcing distribution network infrastructure enabling them to provide extra power required by high number of EVs appearing on the streets in near future as shown in Fig. 1a [5, 6].

Electric train technology has progressed to a mature level and has been commissioned in most countries worldwide. It is worthwhile mentioning that traction substations are normally designed for much higher power capacity than what they normally deliver most of the time. This is due to the fact that high power is only applied on the feeder when the fully loaded train is moving away from the station where the feeder is located. The longer the distance between moving trains and the substation, the lower loading on the relevant feeder. Additionally, these substations are designed to cover total load associated with all moving trains in one section when a nearby substation is out of service for any reason. This is of particular importance for AC trains where more distant substations imply higher nominal power and larger reserved power capacity. All in all, there is substantial amount of electrical power at traction substations in particular during off-peak hours which can be effectively used for EVs parked at train stations. This leads to large savings compared to EVs direct charging from distribution grids as shown in Fig. 1b.

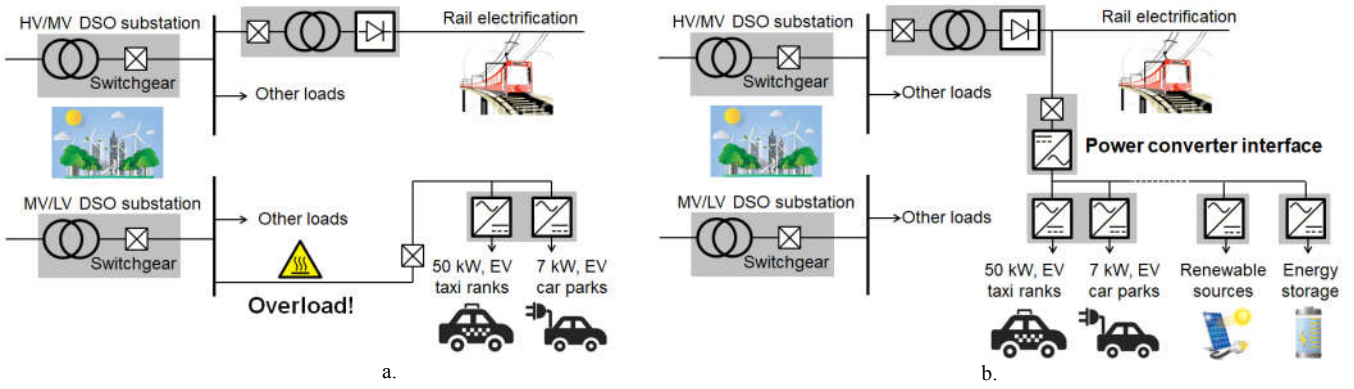

Fig. 1. EV charging system. a. Traditional connection to distribution network, b. Proposed connection to rail traction network

A system-level study of trains regenerative braking power exploitation for EV charging is presented in [7] in which different scenarios of EV charging network connection to traction supply is investigated. A local energy storage system (ESS) is used and a dead-band control is employed for charging and discharging of the ESS considering traction supply DC voltage profile. While no power electronic converter interface is included in this study, it is concluded that best outcome is achieved when ESS is not continuously connected to traction supply.

In [8], a DC micro-grid including PV panels and EV charging points interconnected to DC transmission lines of a DC tramway is investigated. High power DC transformers are used for connection of PV panels and EV chargers to the studied micro-grid and to enable controlled power flow in the system for efficient EV charging. A downscaled experimental lab prototype for EV charging from DC rail traction supply is reported in [9] in which a high capacity DC link representing DC traction network is respectively connected to a local super-capacitive ESS as well as an EV battery via bidirectional and unidirectional DC transformers. One may note that while custom designed DC/DC converters are required, the idea has no realistic implication in real world

implementation given that all AC and DC EV chargers need single-phase or three-phase input power.

This paper proposes a novel solution for EV charging system from traction network in which AC railway traction networks connection to EV charging points (EVCPs) via a power electronic converter is investigated. Using a compact and cost-effective solution, an AC charging network emulating distribution grid is generated from traction supply. Combined single-phase and three-phase EV chargers' connection to the generated grid is possible with no voltage imbalance issue thanks to special arrangement employed for power converter design. Nevertheless, this paper suggests to directly connect single-phase charges to traction supply via an isolation transformer and to employ the proposed bi-directional power converter only for three-phase chargers. While the idea can be equally applied to DC traction networks, AC supplies with higher capacity is mainly concerned in this study.

II. PROPOSED EV CHARGING SYSTEM

Figure 2 shows the schematic of the proposed EV charging system from an AC rail traction supply. It is shown that single-phase charges are directly connected to the traction network via an isolation step-down transformer and AC circuit breakers.

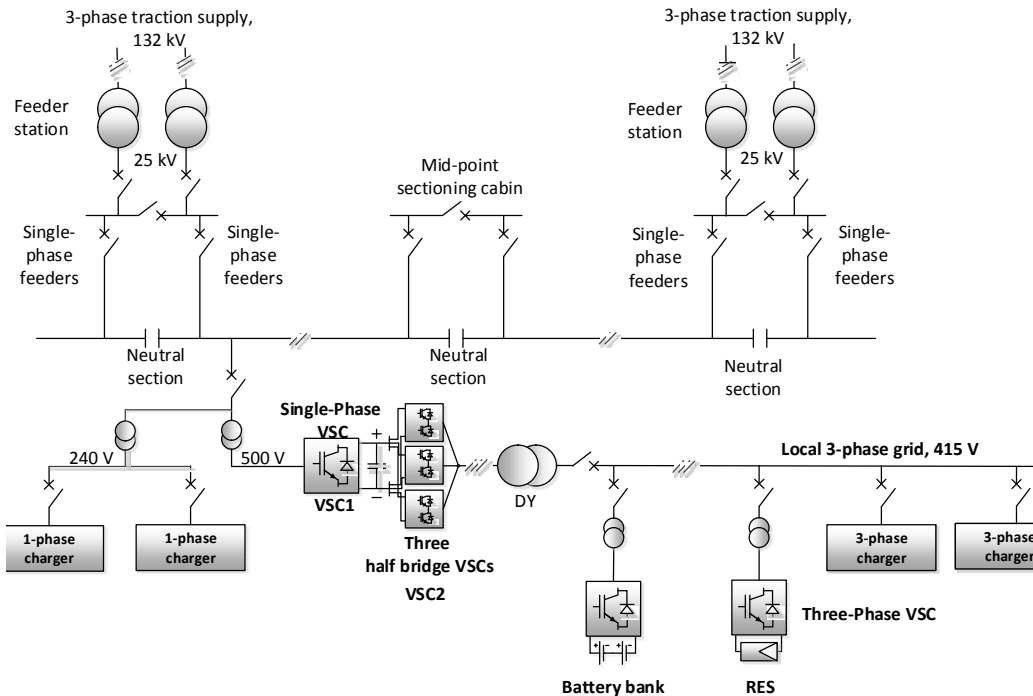

Fig. 2. EV charging from AC rail network: no converter used for single-phase EVCPs

Back to back VSCs are used to convert single-phase traction voltage to a three-phase supply required by EV chargers. Since only three-phase chargers are connected to the power converter, and given that galvanic isolation is achieved inside battery chargers, no isolation transformer is required at the converter output. This leads to further reduction in the system total cost and size. Figure 2 shows that a local ESS of a battery bank and/or renewable energy source (RES) is also considered to feed the EVCPs when not enough power is available from upstream traction network.

This might happen when a fully loaded train is leaving the station nearby the studied substation feeding EVCPs and a heavy load is demanded by EVCPs at the same time. In this way, a real time energy management system is required to continuously monitor the system status in terms of available surplus traction power and actual load demand from EV chargers. This will enable the proposed system when the backup ESS is to be used as the main EVCPs power source and/or whether EVs are needed to charge at reduced power.

It is not necessary to remind that the battery bank and/or RES connected to the local three-phase grid via an off-the-shelf available VSC can also feed single-phase chargers through bi-directional power electronic converter. In this way, the optimized design is obtained if total charging capacity is equally shared between single-phase and three-phase chargers. In normal situation when EVCPs' power is completely provided from upstream traction network, half of total charging capacity associated with three-phase chargers flow through power electronic converter. Alternatively, in the event of any deficit in traction power availability and in the worst case when no traction power is available, half of total charging load associated with single-phase chargers will flow via power electronic converter in opposite direction. This means that power converter is rated for just half of total rail charged EVCP capacity which benefits the system with reduced cost, loss, and footprint.

Conventional voltage-oriented control (VOC) technique is used for both VSCs' controller design and implementation as is shown in Fig. 3 [10]. In this way, a phase locked loop (PLL) is used to identify DQ frame attached to the traction network phasor, V_a . The single-phase VSC is used for DC voltage (V_{DC}) regulation and zero reactive power circulation with AC traction supply in order to reduce interconnected charging system impact on the upstream network. The three-phase VSC is employed for AC voltage and frequency establishment in the local grid and as such external loops are designed for regulation of direct and quadrature components of AC voltage space phasor, V_D and V_Q . Internal current regulation loops for I_D and I_Q components are also employed to provide the converter with fault tolerance property from both AC sides. Modulation indexes of M_x and M_y are obtained from internal PI regulators' outputs with additional decoupling terms dependent on AC leakage inductance L [10].

Note that if DC traction system is concerned, only a three-phase VSC in charge of local grid electrification from upstream DC network is satisfactory. The grid will feed aggregated single-phase and three-phase EV chargers in this case. Given that a weak local grid is exposed to an unbalanced load in this case, a voltage balancing mechanism is also required. This can be achieved using a four-leg VSC with additional power electronic cost and more complex control

system architecture. In this way, we propose application of three synchronized single-phase half bridge VSCs with a three-phase DY transformer to connect the charging grid neutral cable to the transformer star point. Otherwise, the same principles and properties are associated with proposed EV charging from DC traction systems and we do not present further discussion onwards for brevity.

EV charging system infrastructure costs are estimated for one large and one small train station in the UK considering both proposed rail-charge concept as well as traditional distribution system (DNO). The study shows that while similar costs are expected for large case study with more than 1500 car parks, reduced cost to about 50% of using distribution network is envisaged for small station with 50 spaces using the proposed technique. This is of great importance as it indicates that the proposed method is a cheaper solution for small train stations and statistical data shows that more than 80% of train stations in the UK have less than 50 car parks.

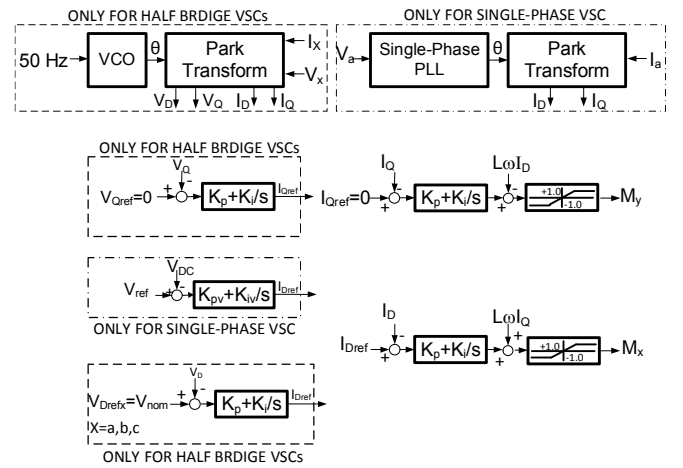

Fig. 3. Proposed power converter controller

III. SYSTEM MODELLING AND SIMULATION RESULTS

The proposed EV charging system shown in Fig. 2 is modelled in MATLAB/Simulink. A 500kW power electronic converter with 800V DC link in charge for three-phase grid electrification is concerned and is connected to traction network via a 25kV/500V step-down transformer. For simplicity EV chargers are modelled as pure resistive loads in this theoretical study but in ongoing experimental verification, real single-phase and three-phase EV chargers will be used. A 500 kW single-phase load is also connected to the system using a step-down 25kV/240V isolation transformer. Passive inductive series filters of 0.9, and 0.1 per unit are respectively used for VSC1 and VSC2 to limit harmonic current injection. Large inductive filter is used for VSC1 to avoid any disruptive interference to the rail way signaling system due to harmonic injection. A 1 MVA battery bank is also connected to the system via a three-phase VSC to support single and three-phase EVCPs in the event of power deficit in rail traction network.

Simulation results are obtained for different operating conditions. It is assumed that a three-phase EV load of 250 kW is initially connected to the system at 0.2 sec which is subsequently increased to rated 500 kW at 0.5 sec. The nominal single-phase charging load of 500 kW is applied to the system at 0.8 sec. The traction power network availability

for EVCPs is assumed to reduce due to train traction loading increase to $1.5 MW$ and $2 MW$ at $1 sec.$ and $1.3 sec.$ respectively. These events are detected by EMS and the battery bank is commanded to start power injection to the local three-phase grid initially at half rated capacity of $500 kW$. The ESS power is further increased to $1 MW$ at $1.3 sec.$ assuming that no traction power is available for EVCPs. The traction power is restored at $1.6 sec.$ and the local back-up source power infeed is terminated accordingly thanks to the proposed system EMS operation.

The performance of active front end VSC1 is depicted in Fig. 4. It is observed that a good tracking of DC link capacitor voltage is achieved. The double frequency component of capacitor voltage is obtained as a result of single phase VSC operation. A notch filter is employed to remove the voltage oscillations feedback to the controller. This figure also shows zero reactive power circulation of rail charge system with upstream traction supply over the whole course of simulation. Thus, no traction feeder capacity is occupied by reactive power and can be effectively used for trains and EV chargers. The converter internal current loops variables are additionally depicted to show active regulation of AC currents. This results in controlled AC fault current indeed from/to rail-charge infrastructure. As a result, no traction substation protection revise is required.

The local three-phase grid voltage phasor components regulated by half bridge VSCs are also shown in Fig. 5. It is shown that good tracking for both components is obtained. The internal current loops' performance is also shown to confirm AC fault current regulation property in the event of AC faults in the local three-phase grid. The time-domain generated three phase voltage and charger load current are shown in Fig. 6. Balanced operation against different EV loading patterns is observed. Although the results are obtained for separate AC charging grids used for single-phase and three-phase EV chargers, but balanced three-phase voltages are expected even with combined connection of both

types of EV chargers to power electronic converter. This will be a result of using three individual half bridge VSCs rather than a usual three-phase VSC as is shown in Fig. 2. The proposed solution enables voltage balancing in the presence of single-phase chargers connection leading to load imbalance without using complex four leg VSCs.

The train power consumption (P_{train}), traction network contribution to EVCPs demand (P_{rail}), as well as ESS power infeed ($P_{battery}$), converter power ($P_{converter}$), and single-phase chargers' powers ($P_{single-phase}$) are shown in Fig. 7.

It is observed that traction supply power shortfall is well covered by battery bank at $1 sec$ and $1.3 sec$ when train loading on traction substation is increased. Fig. 7 shows that power flow reversal is obtained through power electronic converter at $1.3 sec$ when no further capacity is left on traction supply for EVCPs and total EV charging demand is provided from local ESS. In this way, $1 MW$ power is provided from local ESS at $1.3 sec$ for $300 ms$ from which $500 MW$ is transferred to the traction network via power converter for single-phase EV chargers.

In this way, the proposed system needs a power converter rated at half nominal EVCPs power and a single local ESS located at either single-phase or three-phase charging grid. We have assumed a balanced power capacity of single-phase and three-phase EVCPs. This is due to the fact that while high power EV chargers are normally three-phase connected, their application is mainly limited to taxi ranks and electric buses. On the other hand, low power EV chargers are single-phase connected but more popular for all domestic EV users. In this way, equal power sharing between single and three-phase chargers is a likely assumption.

The proposed system gives more benefit with higher share of single-phase EVCPs leading to lower total cost and loss associated with interface power converter. In this case, local ESS must be located at the traction side of the power converter to enable appropriate support for both charging grids.

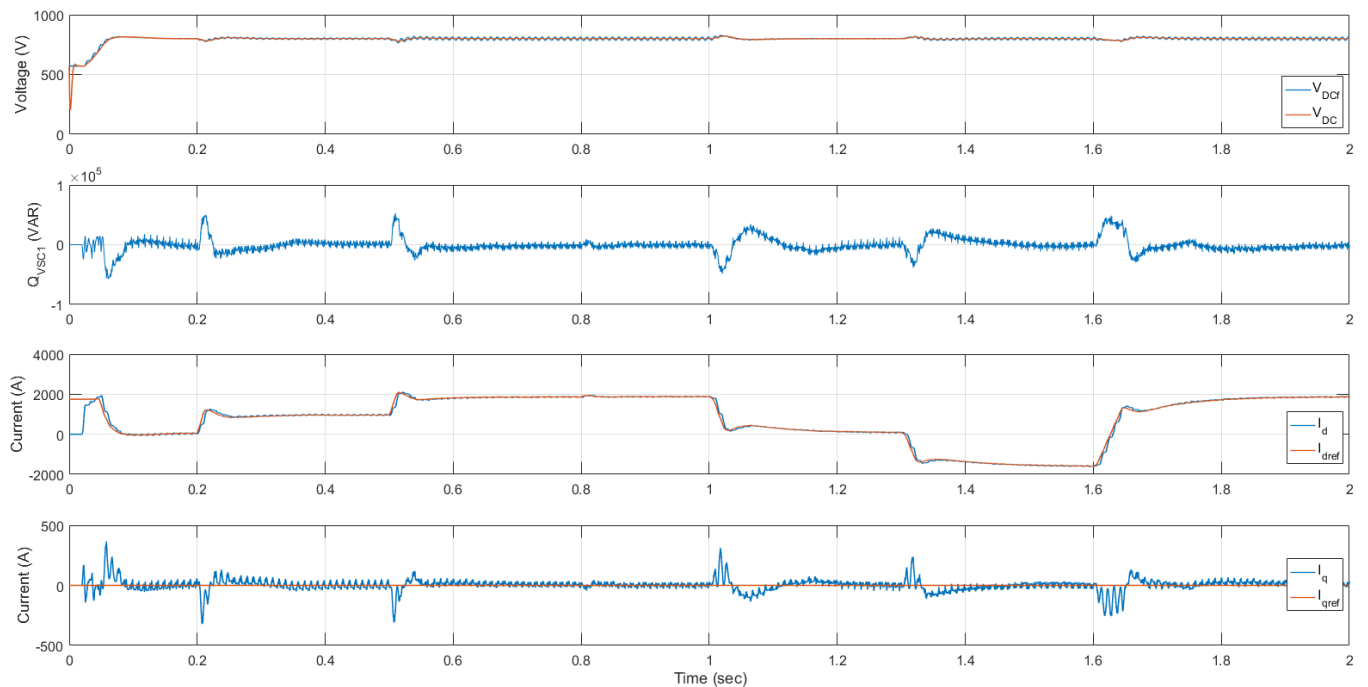

Fig. 4. Active front end VSC variables

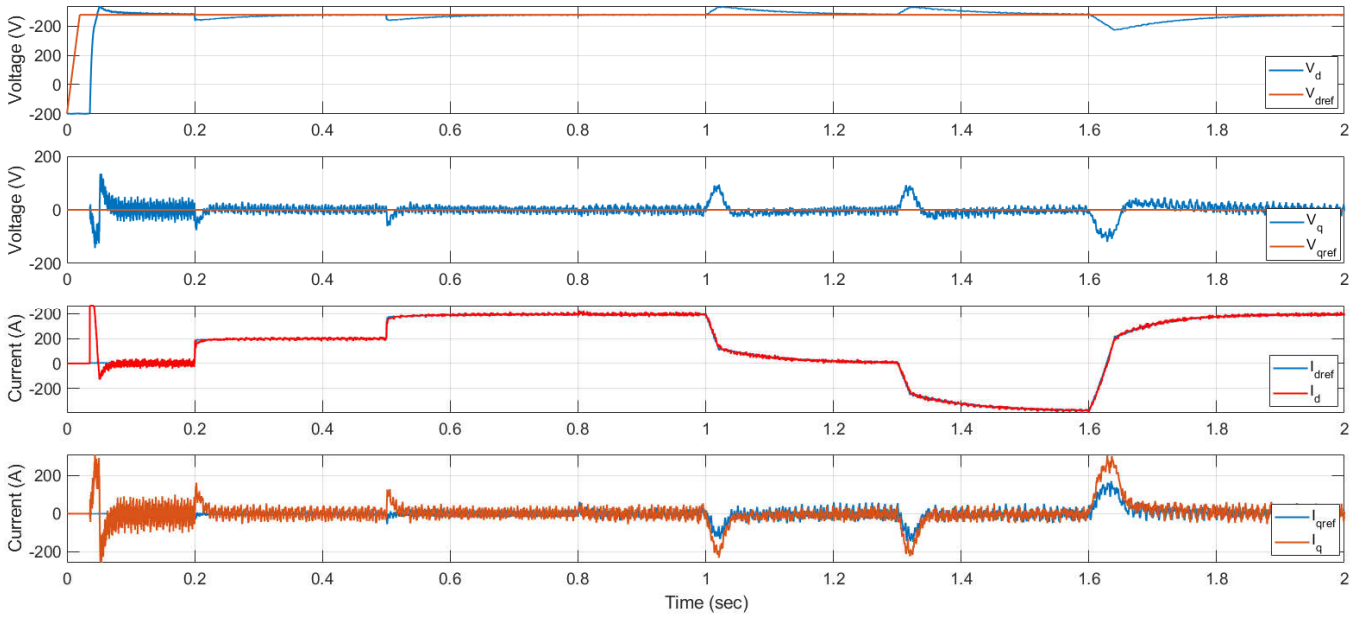

Fig. 5. Three-phase VSC variables

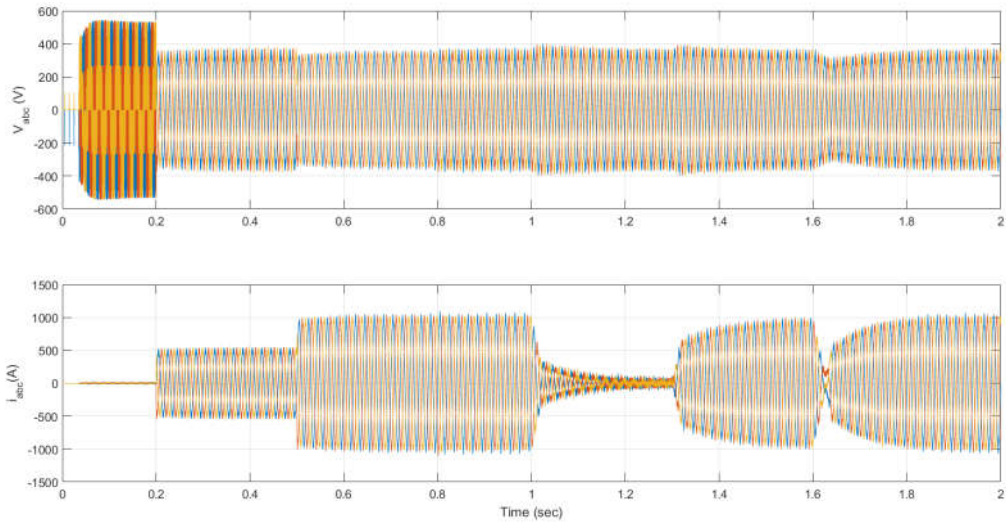

Fig. 6. Local grid three-phase voltage and converter generated current

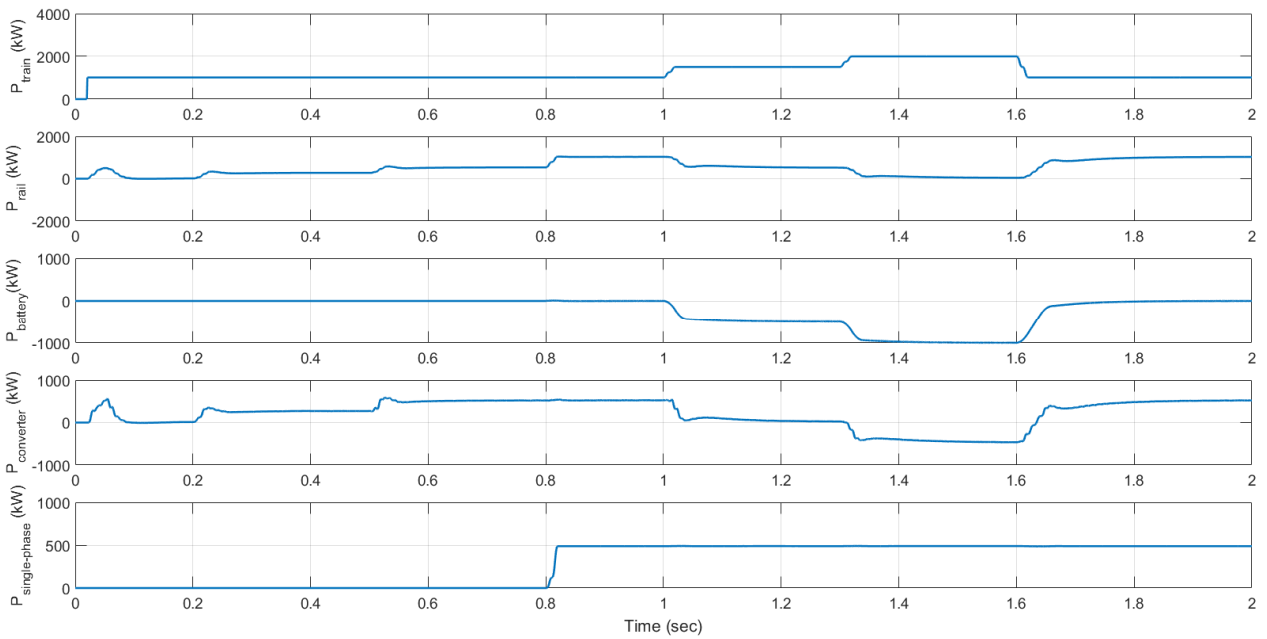

Fig. 7. Power flow variables

Alternatively, with higher power capacity of three-phase EVCPs, larger power converter is required and it is rational to connect local ESS to the three-phase charging system reducing system running costs.

The proposed technique can even be used to transiently support traction supply if the local charger demand is lower than installed capacity. Alternatively, it can be used for traction network voltage stability in the event of AC faults using reactive power injection if required. These can be considered as lateral benefits of the proposed rail-charge system in particular if latest generation of vehicle to grid (V2G) EV chargers are employed.

IV. CONCLUSION

A novel idea for EV charging system design from high capacity rail traction supply is presented. The proposed technique relies on the fact that railway substations have large unused power capacity most of the time which can be exploited for EV charging in large scale. This leads to substantially reduced cost compared to direct use of distribution networks. A power electronic converter is proposed as an interface between traction supply and local charging grid feeding EVCPs. The technique is applicable to both AC and DC rail traction networks connection to EVCPs and can equally be used for commercially available AC and fast DC EV chargers.

An effective method is also presented for separation of single-phase chargers from three-phase ones and direct connection of single-phase chargers to AC traction supply reducing converter cost and loss. A single local ESS including a battery bank or RES integrated to the charging network via an off-the-shelf available VSC converter is also suggested to support EVCPs in the event of less power availability from upstream network. A local EMS system coordinates efficient EV charging from traction network and local ESS. Proposed system simulation results presented at different operating conditions confirm the capabilities of the studied technique. Work is ongoing with a prototype 7 kW laboratory setup development and testing to confirm the effectiveness of the proposed system using experimental results.

V. REFERENCES

- [1] K. Straif, A. Cohen, and J. Samet, "Air pollution and cancer, IARC Scientific publication", no 161, 2013, pp. 49-62.
- [2] P. Kong, G. Karagiannidis, "Charging systems for plug-in hybrid electric vehicles in smart grid: A survey", IEEE Access, October 2016, pp. 6846-6875.
- [3] T. Ma, O. A. Mohammed, "Optimal charging of plug-in electric vehicles for a car-park infrastructure", IEEE Transactions on Industry Applications, Vol. 50, No. 4, July/August 2014, pp. 2323-2331.
- [4] S. Taghizadeh, M. Jahangir, N. Poursafar, J. Lu, G. Konstantinou, "A Multifunctional Single-Phase EV On-Board Charger with a New V2V Charging Assistance Capability", IEEE Access June 2020.
- [5] M. Moschella, M. Murad, E. Crisostomi, F. Milano, "Decentralized Charging of Plug-in Electric Vehicles and Impact on Transmission System Dynamics", IEEE Transactions on Smart Grid, October 2020.
- [6] X. Zhu, B. Mather, P. Mishra, "Grid Impact Analysis of Heavy-Duty Electric Vehicle Charging Stations", in IEEE ISGT 2020 Proceedings, Feb. 2020.
- [7] A.F. Rodrigues, A.F. Cardador, A.P. Cucala, A.J. Lopez, R.R. Pecharman, A.D. Laporte, C.R. Sanchez, " Charging Electric Vehicles Using Regenerated Energy from Urban Railways", in IEEE Vehicle Power and Propulsion Conference (VPPC), 11-14 Dec 2017.
- [8] J. Pouget, B. Guo, L. Bossoney, J. Coppex, D. Roggo, C. Ellert, " Energetic simulation of DC railway micro-grid interconnecting with PV solar panels, EV charger infrastructures and electrical railway network", in IEEE Vehicle Power and Propulsion Conference (VPPC), 18 Nov- 16 Dec 2020.
- [9] P.M. Torres, G. Navarro, M. Blanco, M. Lafoz, " Multifunctional test bench for the emulation and testing of electric vehicle fast-charging from urban railway power lines", in IEEE International Conference on Industrial Technology (ICIT), 17 – 19 March 2015.
- [10] M. Hajian, D. Jovcic, B. Wu, "Evaluation of Semiconductor Based Methods for Fault Isolation on High Voltage DC Grids", IEEE Transactions on Smart Grid, Vol. 4, No. 2, June 2013.