

In-vivo evaluation of microultrasound and thermometric capsule endoscopes

Lay, Holly S.; Cummins, Gerard; Cox, Benjamin F.; Qiu, Yongiang; Turcanu, Mihnea Vlad; McPhillips, Rachael; Connor, Ciaran; Gregson, Rachael; Clutton, Richard Eddie; Desmulliez, Marc Phillipe Yves; Cochran, Sandy

DOI:

[10.1109/TBME.2018.2852715](https://doi.org/10.1109/TBME.2018.2852715)

License:

Creative Commons: Attribution (CC BY)

Document Version

Publisher's PDF, also known as Version of record

Citation for published version (Harvard):

Lay, HS, Cummins, G, Cox, BF, Qiu, Y, Turcanu, MV, McPhillips, R, Connor, C, Gregson, R, Clutton, RE, Desmulliez, MPY & Cochran, S 2019, 'In-vivo evaluation of microultrasound and thermometric capsule endoscopes', *IEEE Transactions on Biomedical Engineering*, vol. 66, no. 3, pp. 632 - 639. <https://doi.org/10.1109/TBME.2018.2852715>

[Link to publication on Research at Birmingham portal](#)

General rights

Unless a licence is specified above, all rights (including copyright and moral rights) in this document are retained by the authors and/or the copyright holders. The express permission of the copyright holder must be obtained for any use of this material other than for purposes permitted by law.

- Users may freely distribute the URL that is used to identify this publication.
- Users may download and/or print one copy of the publication from the University of Birmingham research portal for the purpose of private study or non-commercial research.
- User may use extracts from the document in line with the concept of 'fair dealing' under the Copyright, Designs and Patents Act 1988 (?)
- Users may not further distribute the material nor use it for the purposes of commercial gain.

Where a licence is displayed above, please note the terms and conditions of the licence govern your use of this document.







When citing, please reference the published version.

Take down policy

While the University of Birmingham exercises care and attention in making items available there are rare occasions when an item has been uploaded in error or has been deemed to be commercially or otherwise sensitive.

If you believe that this is the case for this document, please contact UBIRA@lists.bham.ac.uk providing details and we will remove access to the work immediately and investigate.

In-Vivo Evaluation of Microultrasound and Thermometric Capsule Endoscopes

Holly S. Lay , *Member, IEEE*, Gerard Cummins , *Member, IEEE*, Benjami F. Cox, Yongqiang Qiu , Mihnea Vlad Turcanu , Rachael McPhillips, Ciaran Connor, Rachael Gregson, Eddie Clutton, Marc P. Y. Desmulliez , *Senior Member, IEEE*, and Sandy Cochran , *Member, IEEE*

Abstract—Clinical endoscopy and colonoscopy are commonly used to investigate and diagnose disorders in the upper gastrointestinal tract and colon, respectively. However, examination of the anatomically remote small bowel with conventional endoscopy is challenging. This and advances in miniaturization led to the development of video capsule endoscopy (VCE) to allow small bowel examination in a noninvasive manner. Available since 2001, current capsule endoscopes are limited to viewing the mucosal surface only due to their reliance on optical imaging. To overcome this limitation with submucosal imaging, work is under way to implement microultrasound (μ US) imaging in the same form as VCE devices. This paper describes two prototype capsules, termed Sonocap and Thermocap, which were developed respectively to assess the quality of μ US imaging and the maximum power consumption that can be tolerated for such a system. The capsules were tested *in vivo* in the oesophagus and small bowel of porcine models. Results are presented in the form of μ US B-scans as well as safe temperature readings observed up to 100 mW in both biological regions. These results demonstrate that acoustic coupling and μ US imaging can be achieved *in vivo* in the lumen of the bowel and the maximum power consumption that is possible for miniature μ US systems.

Index Terms—Capsule endoscopy, ultrasound array, microultrasound, high-frequency ultrasound, *in vivo* testing, safety testing.

I. INTRODUCTION

GASTROINTESTINAL (GI) pathologies, such as Barrett's oesophagus, coeliac disease, inflammatory bowel disease, and colorectal cancer are recognized as a significant public health issues, leading to a growing number of GI-related endoscopic procedures performed worldwide, including in the UK

Manuscript received March 23, 2018; revised May 18, 2018; accepted June 30, 2018. Date of publication July 5, 2018; date of current version February 18, 2019. This work was supported by the UK Engineering and Physical Sciences Research Council under the Grant EP/K034537/1 and entitled Sonopill. (*Corresponding author: Gerard Cummins.*)

H. S. Lay, Y. Qiu, M. V. Turcanu, R. McPhillips, C. Connor, and S. Cochran are with the School of Engineering, University of Glasgow.

G. Cummins is with the School of Engineering and Physical Sciences, Heriot-Watt University, Edinburgh EH14 4AS, U.K. (e-mail: G.Cummins@hw.ac.uk).

B. F. Cox is with the School of Medicine, University of Dundee.

R. Gregson and E. Clutton are with the Royal (Dick) School of Veterinary Studies, University of Edinburgh.

M. P. Y. Desmulliez is with the School of Engineering and Physical Sciences, Heriot-Watt University.

Digital Object Identifier 10.1109/TBME.2018.2852715

National Health Service (NHS) [1]. Endoscopic procedures such as upper GI endoscopy, terminating at the proximal duodenum, small bowel enteroscopy, and colonoscopy are required to image the luminal surface of the GI tract, i.e., the mucosa. Video capsule endoscopy (VCE) has emerged as a viable alternative to these methods for some clinical conditions since being introduced over 10 years ago [2]. The small size and shape of a VCE device, typically a cylinder with hemispherical ends with diameter 10 mm and maximum length \sim 30 mm, enables it to be swallowed by a patient without sedation and with reduced discomfort, hence obviating the need for highly trained staff. A camera in the capsule images the entire length of the small bowel, which cannot be easily reached with conventional endoscopy. However, optical imaging is the only available diagnostic capsule imaging modality and it allows observation only of the mucosal surface. Subsurface imaging is possible with conventional endoscopic ultrasound (EUS) but this is intended mainly for imaging beyond the GI tract, using it as a window into other organs. Because it is based on frequencies below the \sim 20 MHz operating limit of conventional ultrasound imaging, spatial resolution is limited and EUS devices cannot, in any case, be applied to the full length of the small bowel [3].

Integration of microultrasound (μ US) imaging, with frequency \geq 30 MHz, into a capsule endoscopy (CE) device has the potential to provide subsurface imaging of the small bowel, complementing optical imaging whilst providing additional data for clinical GI diagnoses. However, the development of microultrasound capsule endoscopy (μ USCE) must address challenges in transducer design and packaging as well as identification of translational routes into clinical practice.

Research has begun in the area of ultrasound capsule endoscopy (USCE) [4], [5] at ultrasound frequencies suitable for imaging beyond the GI tract, mimicking conventional EUS. Work has also been done on μ USCE, both in systems design [6] and experimental demonstrations [7]. However, examination of the signal quality offered by direct or fluid-mediated ultrasonic coupling between tissue and the capsule has been limited. Poor coupling has a direct negative impact on the quality of the resulting images and will particularly affect μ USCE devices. Additionally, μ USCE demands higher electronic complexity than both existing VCE devices and potential USCE at conventional frequencies because of the higher frequency of operation and larger number of imaging array elements needed to achieve the same aperture [6]. It thus has the potential to dissipate more

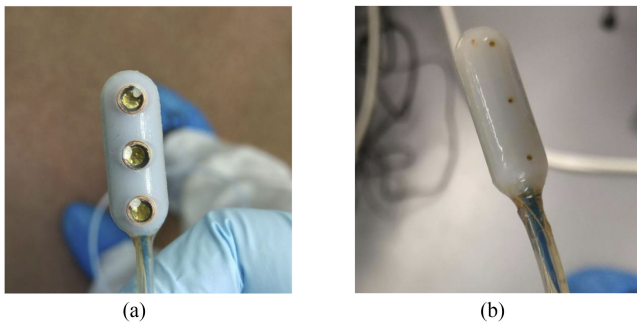

Fig. 1. (a) Sonocap μ US capsule, showing three of the four transducers it contains. (b) Thermocap capsule showing thermistors embedded in the shell.

power, raising concern that IEC safety thresholds [8] could be exceeded, causing thermal damage in the surrounding tissue. This thus requires testing of the power threshold that causes the maximum permitted heating of tissue.

To address these two issues, the tethered capsule prototypes shown in Fig. 1 were built, with the specific aims to demonstrate basic μ US imaging and to measure temperature during heating in preclinical testing with a porcine model. One capsule, termed Sonocap, was designed to assess whether coupling of tissue to the capsule endoscope was sufficient for microultrasound imaging. The other capsule, termed Thermocap, was designed to establish power limits under steady state and dynamic conditions to prevent excessive heating of surrounding tissue, as well as to determine the resulting thermal profile throughout the capsule during testing *in vivo*. Emerging from a larger, multifaceted programme of research [9], this paper outlines the design and fabrication of the Sonocap and Thermocap capsules and the results they generated during tests *in vivo*.

II. METHOD

A. Microultrasound Imaging System Design

The wall surrounding the lumen of the human GI tract is composed of four cardinal layers of specialized tissue as shown in Fig. 2, which, from the lumen outwards, comprise the mucosa, submucosa, muscularis propria and serosa.

Each layer is relatively thin (max. 1–2 mm) with respect to conventional US imaging wavelengths and frequencies making μ US in the 20–50 MHz frequency range (wavelength, $\lambda \approx 75$ – $30 \mu\text{m}$ respectively) best suited for USCE applications with the intention to image the gut wall. Previous work has shown that μ US can allow differentiation between these layers as well as quantitative analysis [10]–[12].

Sonocap contains four single-element spherically-focused μ US transducers made with $9 \mu\text{m}$ thick polyvinylidene fluoride (PVDF, Precision Acoustics, Dorchester, UK) to operate at 30 MHz, $\lambda \approx 50 \mu\text{m}$, with a focal distance of 6 mm. The diameter of the PVDF is 4 mm, $f\# = 1.5$, and a 3 mm thick backing layer is used [13], [14]. Three of the transducers were placed along the longitudinal axis of the Sonocap surface with the fourth transducer situated at a 180° rotation from the others at the front of the capsule, distally with respect to the tether. The

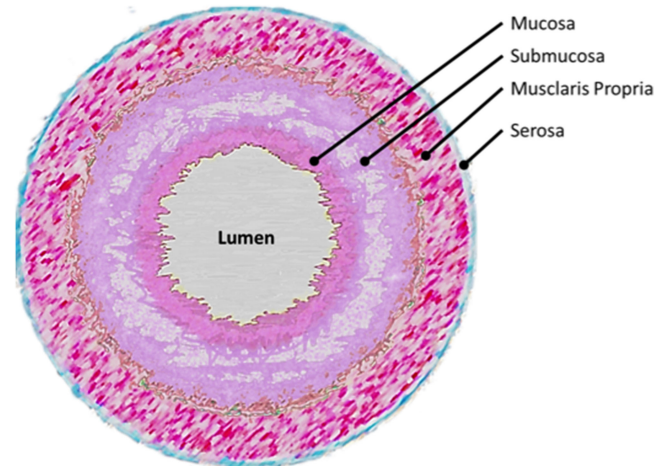

Fig. 2. Histology of the small bowel. Organization of the gastrointestinal wall is generally well conserved from distal oesophagus to rectum. Principal layers, from inner luminal surface (top) outwards, are the mucosa, submucosa, muscularis propria and serosa.

locations of the transducers were chosen to allow a comparison of image quality as a function of their position along the axis of the capsule, as well as to be able to image diametrically opposed points on the lumen at a given location along its length.

A custom printed circuit board (PCB) within the capsule housed an analogue amplification circuit for the received echoes from each transducer. This comprised a 4-channel T/R switch (MD0101, Microchip Technology, Chandler, USA) in series with a 4-channel low noise amplifier (LNA) (ADA4807, Analog Devices, Norwood, USA) configured for 12 dB of gain. The transmission signals to generate μ US from the transducers and the received echoes after amplification were transferred in and out of the capsule respectively via eight micro-coaxial cables (42 AWG core, 9442 WH033, Alpha Wire, Elizabeth, USA) with power supplied to the LNAs via two 38-gauge (0.1 mm diameter) wires, tethering Sonocap at one end.

B. Thermometry System Design

The first design for the Thermocap capsule had twelve thermistors (10 k Ω B57540G1103F000, EPCOS, Bracknell, UK) located within holes evenly spaced around the circumference and along the longitudinal axis of the capsule, with another thermistor and a humidity sensor (SHT25, Sensiron AG, Switzerland) placed inside the capsule. Initial testing *in vivo* showed that the low temperature gradient around the capsule did not justify this number of thermistors. Subsequent capsules were therefore designed to contain six external thermistors, still with one internal thermistor. The external thermistors provide a full temperature profile of the capsule under different heating and ultrasonic couplant fluid flow conditions and the internal thermistor and humidity sensor monitor the operating conditions of the electronics.

The thermistors were read using simple voltage dividers which were mounted on two miniature PCBs along with two voltage regulators to ensure stability of the readings. A power resistor (24 m Ω , 1 W, ERJ8BW, Panasonic Corporation, Osaka,

Japan) was also included as a heat source. External control was achieved via an isolated power line allowing precise control of the current to the power resistor while two other lines supplied power to the regulators. Temperature readings were achieved through probe points connected to each sensor via micro-coaxial cables the same as those used in the Sonocap capsule.

C. Capsule Construction and Assembly

The capsules for both modalities, length 30 mm, diameter 10 mm, as previously noted, had a 3.3 mm diameter port at one end for insertion of a tether. Additionally, the Thermocap capsule contained a series of equidistant cavities for the insertion of thermistors and the Sonocap capsule contained four cylindrical recesses for placement of the ultrasound transducers. All capsules were additively manufactured from Verowhite using an Objet Connex 500 (Stratasys, MN, USA). The capsules were orientated during production such that the outer surface had a smooth, gloss finish. The capsules were composed of two semi-cylindrical parts which were aligned together with a mating lip present along the outer edge. The PCBs of the modality required were placed in the internal cavity of the capsule and a USP Class VI epoxy (EPH42T-MED, Masterbond, NJ, USA) was manually dispensed with a syringe along the lip structure of the capsules before they were fitted together and left to cure at room temperature for 24 hr. Adhesive bonding was used to ensure that all assembly occurred below the Curie temperature and melting point of the PVDF transducers.

An 8 μm thick film of Parylene C was deposited onto the external surface of the Verowhite capsules using a vacuum deposition tool (SCS PDS 2010, Specialty Coating Systems, IN, USA). The surfaces were primed with A174 silane adhesion promoter before deposition. Parylene C is a USP Class VI polymer, used as a means to ensure biocompatibility for many medical devices. It is commonly deposited via vapour phase deposition to achieve a conformal coating that acts as a good moisture and dielectric barrier with excellent lubricity even for films only a few microns thick.

A perfluoroalkoxy alkane tube (PFA, Adtech, UK) with 2 mm inner diameter, 3 mm outer diameter, was used to sheath the wires connecting the capsule electronics to external driving and data-logging equipment. Before attachment to the tether port, the PFA tube was functionalized to ensure good adhesion using Fluoroetch (Acton Technologies, PA, USA) according to the manufacturer's instructions. The tether was bonded in place using EPH42T-MED. The quality of the seal, mechanical robustness and transmission of chemical leachates from empty capsules were quantified prior to insertion [15] to verify safety.

D. Data Acquisition

To facilitate experimental set-up and repeatability, the capsule control and data acquisition equipment were located on a cart suitable for use during *in-vivo* testing, Fig. 3. System control was achieved with a laptop computer running custom software coded in LabVIEW (National Instruments, Austin, USA) paired with a

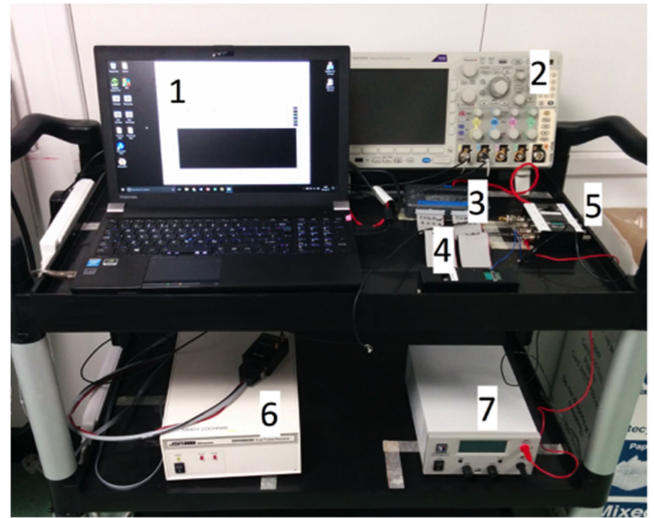

Fig. 3. Cart supporting the control and data acquisition hardware for the Sonocap and Thermocap devices: 1) Labview-based acquisition GUI, 2) Ultrasound acquisition and monitoring oscilloscope, 3) MyRIO, 4) Thermocap breakout box, 5) Sonocap breakout box, 6) DPR500 Ultrasonic Pulser/Receiver, and 7) Power resistor supply.

myRIO-1900 acquisition device (National Instruments, Austin, USA) and a commercial ultrasonic pulser/receiver (DPR500, JSR Ultrasonics, Pittsford, USA), a high current power supply (EA-PS 2084-03 B, Elektro-Automatik, Vierns, Germany) and a 2 GS/s oscilloscope (MDO3024, Tektronix, Beaverton, USA). The proximal end of the tether was attached to the myRIO device for real-time data acquisition and control as shown in Fig. 4.

A custom breakout board was designed for each capsule to interface between the appropriate ports of the myRIO and the tether. The Thermocap breakout box connected two 5 V lines from the myRIO to the voltage regulators on-board the capsule and a separate line from the on-board power resistor to the stand-alone power supply. The return lines from the thermistors were passed through a 2:1 multiplexer to reduce the channel count for digitization. Operational amplifiers with a gain of +12 dB conditioned the signal for input to the myRIO device. The breakout box also passed through the I²C channels from the myRIO device to the humidity sensor.

The Sonocap breakout box supplied ± 15 V DC drawn from the myRIO device to the on-board capsule amplifiers and allowed coaxial connections from the pulser/receiver to each of the four on-board transducers' transmit/receive lines. The beam-formed data from the transducers was logarithmically compressed post-envelope detection and normalised with respect to the strongest echoes in the image. Echoes more than 30 dB less than the highest echo were then trimmed. The resulting data set mapped to a red/blue colour map, which clinicians subjectively determined was best for quickly visualizing data.

E. Trial Setup

Porcine models were used because of the similarity of their GI tract to the human GI tract in terms of physiology and histological structure [16]. The study was conducted under Home Office (UK) License (Procedure Project Licence (PPL):

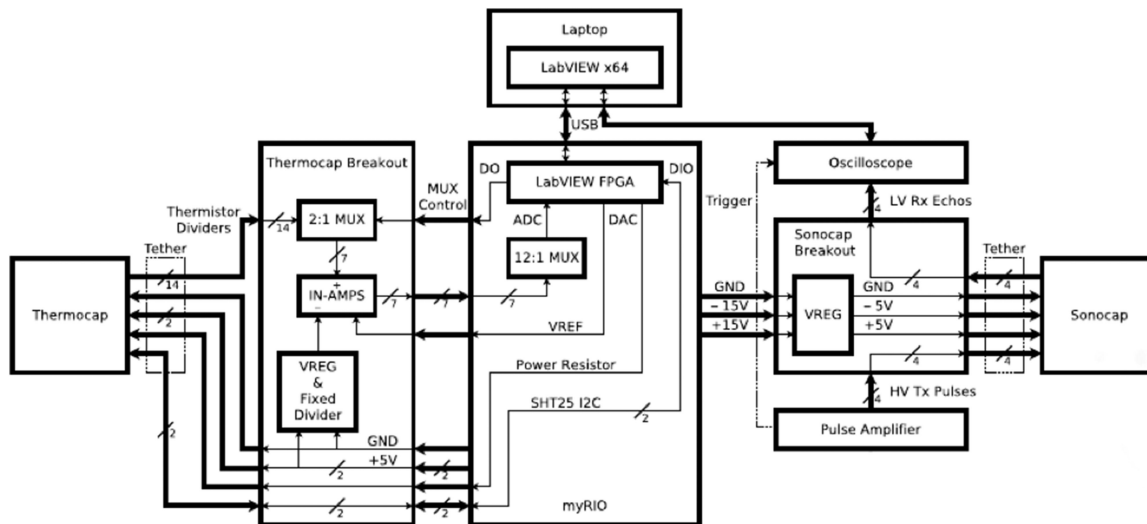

Fig. 4. Block diagram of the data acquisition system showing the LabVIEW-based PC control, myRIO, Sonocap, and Thermocap breakout boxes, pulser/receiver and oscilloscope. The software on the PC is used to initialize and control the myRIO module, which supplies DC power supplies (+5 V, ± 15 V) to both the Thermocap and Sonocap breakout boxes, as well as controlling the Thermocap multiplexers, sampling the thermistor signals which are amplified within the Thermocap breakout, and capturing data from the humidity sensor via I2C communications.

TABLE I
DETAILS OF CLINICAL ANAESTHESIA

Drug	Concentration	Full Name	Source
Azaperone	1 mgkg ⁻¹	Stresnil	Elanco Animal Health, Hampshire, UK
Ketamine	2 mgkg ⁻¹	40 mg/ml solution for injection Ketamidor	Roche, Hertfordshire, UK
Midazolam	0.5 mgkg ⁻¹	100 mg/ml Solution for Injection Hypnovel	Roche, Hertfordshire, UK
Morphine	0.25 mgkg ⁻¹	10 mg/ml Solution for Injection Morphine Sulfate 30 mg/ml	Martindale Pharmaceuticals, Buckinghamshire, UK

70/8812) in accordance with the Animal (Scientific Procedures) Act 1986. Six female Landrace pigs were anaesthetized for the experiments; they were euthanized after the experiments were complete.

The six pigs, weighing in the range 56–64 kg and aged in the range 3–4 months, were obtained from a local breeder/supplier. Before the study, the pigs were kept in licensed housing (UK Project Establishment License 60/4604), bedded on straw, and fed *ad lib* pig rearer pellets (ABN, Cupar, UK) in groups of no less than two animals. Environmental variables were maintained within the limits detailed by the Project Establishment License. Food was withheld for 12 hours before anaesthesia but access to water was maintained until pre-anesthetic medication was injected intramuscularly (Table I). Anaesthesia was induced with isoflurane (IsoFlo, Zoetis, Surrey) vaporized in oxygen and nitrous oxide administered via a Bain breathing system and facemask. A cannula was placed in the auricular vein and the trachea was intubated. Anaesthesia was maintained with isoflurane. Ringer's lactate solution (Aqupharm No 11, Animalcare, York, UK) was administered at 10 ml kg⁻¹ hr⁻¹ throughout each study to maintain fluid and electrolyte levels.

For oesophageal experiments, all the pigs were placed in a supine position as shown in Fig. 5(a). For small bowel studies four pigs were placed supine and two were placed on their

sides. The animals were draped to maintain body temperature whilst allowing access to the stomas through which the capsules were inserted into the small bowel. Because of the shared space issue with anaesthetic intubation, a modified, wide-diameter endotracheal tube was inserted transorally into the oesophagus. This allowed rapid, direct access to the proximal oesophagus as shown in Fig. 5(b). Access to the remote small bowel was gained with a stoma created under general anaesthesia immediately prior to the experiment presented in Fig. 5(c).

The anaesthetized pigs' lungs were mechanically ventilated to maintain normocapnia. Vital signs were monitored throughout the experiment by an experienced veterinary anaesthetist. When the experiments were complete, the animals were euthanized using pentobarbital.

F. Ultrasound Capsule Test

For the Sonocap device, similar protocols were used in the oesophagus and small bowel, with measurements being performed on each of the six pigs. For the oesophagus, the capsule was inserted orally, as assessed by the veterinary surgeon, and continuous pulse-echo data was captured on each transducer while the capsule was retracted to the mouth. For the small bowel, the stoma created in each animal allowed access

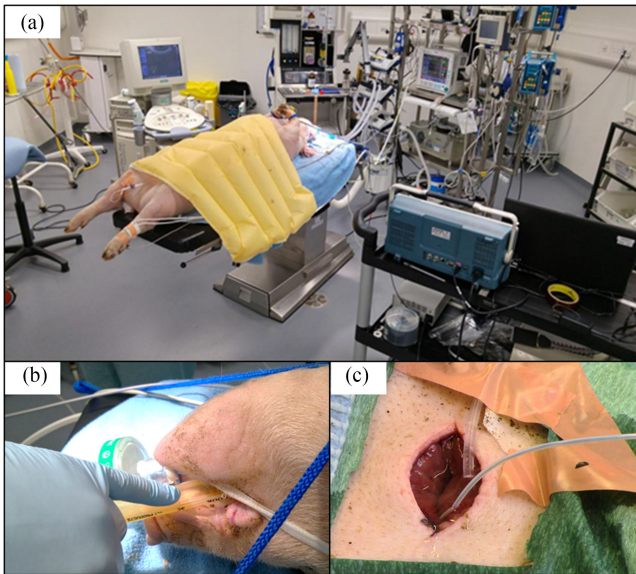

Fig. 5. Operating room set-up for porcine model trials. (a) Equipment setup including anesthetic and subject monitoring devices (upper right), standard ultrasound machine (centre left) and experimental trolley (lower right). Test subject with warming blanket centre. (b) Modified endotracheal tube (ET) allowing direct access to the oesophagus. (c) Artificial small bowel stoma with capsule inserted (tether visible). The saline drip used for ultrasound coupling is shown on the upper part of the stoma.

to both proximal and distal small bowel sections and the capsule was inserted 60 cm through the stoma. In each case, an attempt was made to insert the capsule in the antegrade (proximal to distal) direction; however, the lack of external guidance meant that this could not be guaranteed. The capsule was then manually pulled 12 cm back towards the mouth of the stoma over a 30 second duration while μ US signals were recorded. Lubrication of the capsule and coupling of the transducers to tissue was achieved with a saline drip (~ 1 -2 drips/s) located at the entrance to the oesophagus or stoma as seen in Fig. 5(c).

G. Thermometry Capsule Test

In the experiments in both the oesophagus and the small bowel, the core temperature of the pig was recorded continuously with rectal thermometry (Datex S5 Multi-parameter monitor, Datex Engstrom Inc., MA, USA). In each case, the Thermocap device was fixed in position and the current supplied to the power resistor within it was incremented in steps $\delta I = 100$ mA DC up to $I = 1$ A, when the power supplied $P = 100$ mW. The temperature of the resistor was allowed to stabilize for one minute after each step and the temperature of each thermistor was recorded using the myRIO. The thermistor temperatures were also monitored continuously to ensure that the surface temperature never exceeded 43 °C, the pre-determined tissue damage threshold [8], [17]. In case of excess temperature, a kill switch located on the external trolley allowed the current to the capsule to be shut down immediately. The capsules were run with no active heating for ten minutes between experimental repeats to allow a full return to steady-state. Finally, two heating cycles were performed in the small bowel after euthanasia to observe the effect of tissue cooling on the heating profile.

III. RESULTS

A. Oesophageal Test Results

Initial Thermocap tests were performed in the oesophagus without any coolant as a worst-case scenario. A second set of tests was performed with a saline drip to replicate the environment used in the US coupling tests. Consistent linear temperature responses were recorded as a function of temperature, Fig. 6, for all test conditions, with the slope dependent on the presence or absence of external cooling. $P = 100$ mW was used in all test runs without the capsule surface temperature exceeding 43 °C. The highest surface temperature observed was in the non-saline cooled (dry) oesophagus, where one test reached a temperature of 41.5 °C. However, *post mortem* dissection showed no visible damage to the tissue, confirming the previously established safety thresholds. With the exception of P1 T1 Therm1 and P2 T2 Therm1, all tests fell within the IEC test guidelines for initial tissue temperature ($T \geq 37$ °C) and all tests fell under the maximum temperature rise limits ($\Delta T \leq 6$ °C) [8].

Preliminary Sonocap experiments were performed with standard acoustic gel to achieve acoustic coupling in the oesophagus with the Sonocap device. However, these results showed poor coupling due to large air bubbles created during the introduction of the capsule into the oesophagus. Acoustic coupling was then changed to a saline drip directly into the oesophagus at ~ 2 drip/s, resulting in good coupling for pulse-echo tests. This drip rate was determined based on the natural capacity of the oesophagus during the testing procedure.

Images of the oesophagus were successfully captured, Fig. 7, with this second test protocol, though the quality of the oesophageal images was lower than desired due to the tissue being consistently in the near field of the focused transducer during pullback. However, this allowed imaging of characteristics of the subsurface tissue, which can be seen in Fig. 7 (red arrows). A-scans were collected through the duration of the pullback and are displayed sequentially along the x-axis, with 10 times linear interpolation applied between the numbered A-scans to smooth the image.

B. Small Bowel Test Results

The Thermocap measurements performed in the oesophagus were repeated in the small bowel, Fig. 8, though all small bowel measurements were made with a saline drip to avoid moisture loss from the exposure of the internal tissues to the external environment via the stoma. A larger variation in core body temperature was seen in these experiments because of the additional tissue cooling and limited ability to use blankets to cover the pig due to the stoma open in the abdomen. Because of this, only one trial (B1 T1, Fig. 8) began above the IEC specified starting temperature [8]. However, all tests fell well within the 6 °C temperature rise limit. To determine whether the temperature increase above the core temperature was dependent on initial temperature and overall circulation, a final set of tests was performed *post mortem*, which confirmed that the temperature - power relationship remained constant even with much lower core temperatures and no circulation.

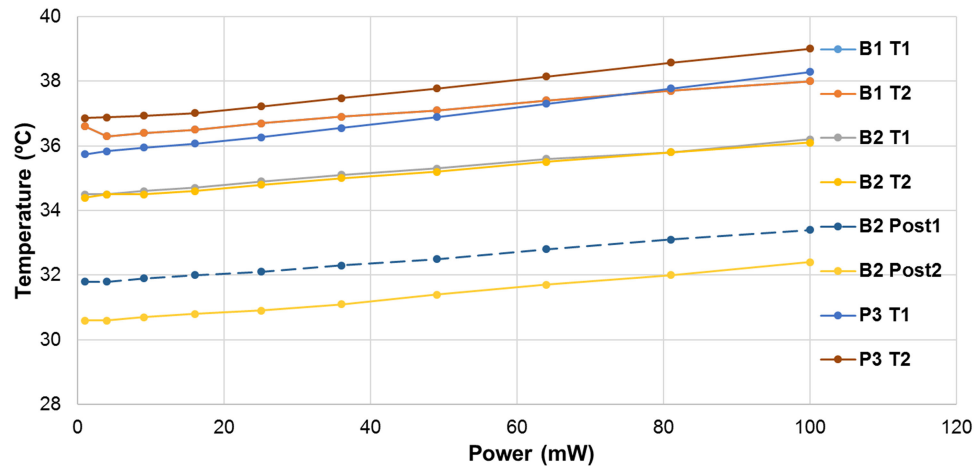

Fig. 6. Maximum external temperature readings as a function of the steady-state power delivered to an internal power resistor in the oesophagus with no saline drip (solid lines) and with saline drip (dashed lines).

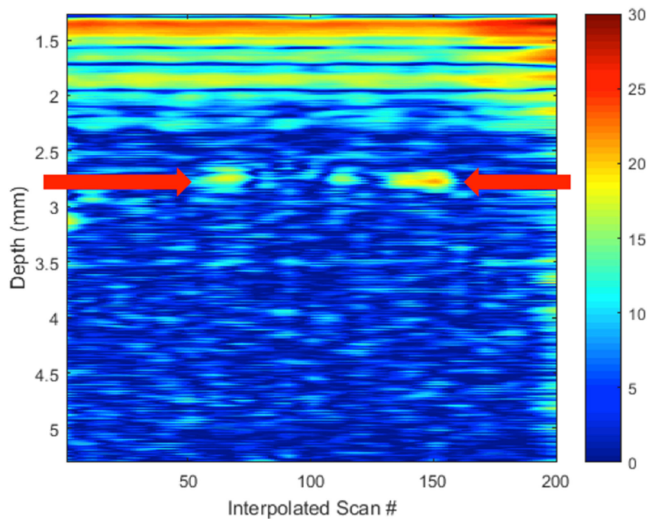

Fig. 7. 30 MHz microultrasound image of the porcine oesophagus obtained with a single element PVDF transducer. The capsule imaging was performed from the top of the image looking down onto the tissue surface. The oesophagus was scanned from just proximal to the stomach (left hand of image) to the entry to the tube used to introduce the capsule into the oesophagus (right hand side). Defocused tissue close to the transducer can be seen at the top of the image, with sub-surface tissue features visible between 2.5 and 3.5 mm (red arrows).

Based on the results from the oesophagus, all Sonocap experiments in the small bowel were performed with a saline drip at 1 drip/s. This delivery rate was less than for the oesophagus to prevent pooling of fluid in the loops of the small bowel because of the reduced natural capacity of the smaller bowel dimensions compared with the stomach and oesophagus. Good acoustic coupling was achieved with the tissue and the longer length of the small bowel allowed for longer capsule pull-backs, extending the lateral imaging range, Fig. 9. Better tissue stand-off was also observed in these trials, with the primary tissue layers falling within the focal zone of the transducers, allowing for good layer resolution.

μ US coupling with Sonocap could not be achieved without external delivery of a coupling medium. Successful coupling was achieved in both the oesophagus and small bowel using a saline drip, with images obtained in both cases for μ US at 30 MHz. This suggests that coupling may also be achieved in human clinical work if patients consume water with the capsule. Consumption of water would also reduce any concerns with heating, as seen in the temperature measurements.

It was found that the tissue in the oesophagus pressed up against the surface of the transducers to a greater degree than expected, reducing the ability of the capsule to resolve the layered tissue structure. This suggests that future devices intended for use in the oesophagus will need focal zones closer to the μ USCE device surface, either by recessing the transducer into the body of the device or by narrowing the physical focal zone during transducer fabrication. However, in the small bowel, the bowel walls generally fell into the 5–6 mm focal zone of the transducers, allowing good visualization of the tissue layers.

For future capsule development, this suggests that capsules may need customized focal zones dependent on the target anatomy. Alternatively, the use of transducer array imaging [6] will allow focal zone variation according to location. Data from the small bowel showed the tissue generally fell in the range 3–7 mm from the faces of the transducers, making that a suitable focal range for bowel work. However, the oesophagus scans all featured tissue in direct or near-direct contact with the transducers, suggesting that a better design for esophageal work would feature a recessed transducer with the focal zone beginning flush with the surface of the capsule, allowing the front tissue surface to be resolved independently of the transducer near field effects.

All Thermocap tests showed linear increases in temperature as a function of applied power. However, the slope and initial temperature readings were dependent on physical location and testing conditions. In the oesophagus, it was found that the temperature rise was much more rapid under dry conditions, which was expected, as the saline drip supplied active cooling to the surface of the capsule. In the small bowel, the rate of increase was consistent across all experiments but the base temperature

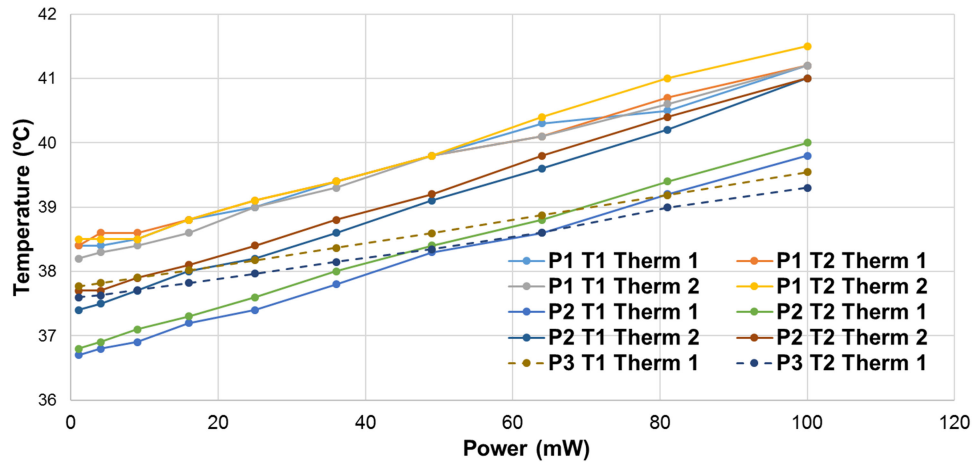

Fig. 8. Maximum external temperature readings as a function of the steady-state power delivered to an internal power resistor in the small bowel with saline drip both *in vivo* (solid lines) and *ex vivo* (dashed lines).

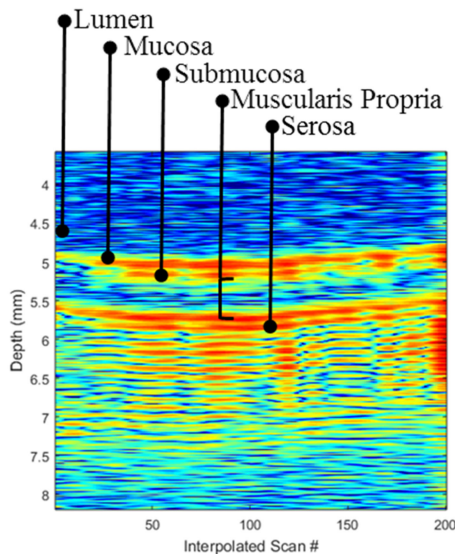

Fig. 9. μ US image of the porcine small bowel obtained with a single element PVDF transducer. The capsule imaging was performed from the top of the image looking down onto the tissue surface and the full image was obtained during a 12 cm capsule pull-back. Multiple tissue layers can be seen, with a total thickness of ~ 2.5 mm.

recordings were lower due to the necessary exposure of the bowel to the outside environment to allow experimental access. This reduction in the starting temperature was also seen in the rectal temperature readings.

In all Thermocap tests, total temperature increase over the full power range was less than 6°C , conforming to the IEC standard for continuous self-heating of ultrasonic probes [8]. However, while all but two of the tests in the oesophagus met the initial temperature requirements of the standard, the issues with temperature maintenance in the small bowel experiments led to only one test case meeting the initial temperature threshold. Additional testing will be required in the small bowel with better initial temperature control to confirm IEC conformance for this application. Nevertheless, the consistency of the temperature increase independent of initial temperature strongly suggests

that the capsules will maintain conformance at these power levels given correct starting conditions.

Based on the results, an overall power threshold of 100 mW has been established in our work for future capsule development. This is a reasonable power threshold, as current VCE designs feature a 20 mW power profile for two battery solutions [18] with some designs expanding to four batteries to double the power threshold to 40 mW [19]. The additional power budget allowed by the 100 mW threshold should be sufficient for the additional sensing modalities, provided the active duty cycle is appropriately controlled.

IV. CONCLUSIONS

Two prototype test devices, Sonocap and Thermocap, have been described along with results obtained from them in μ US and power/temperature testing in a porcine model *in vivo* to provide useful guidance for future development of USCE. μ US at 30 MHz was found to be sufficient to distinguish tissue layers in the small bowel and subsurface tissue in the oesophagus. Saline drips at 1–2 drips/s were found to achieve satisfactory coupling in our work. Thermal testing established a 100 mW power ceiling which is consistent with previous limits of ~ 500 mW [20], [21], given the smaller size and reduced tether dimensions.

REFERENCES

- [1] J. Williams *et al.*, "Gastroenterology services in the UK. The burden of disease, and the organisation and delivery of services for gastrointestinal and liver disorders: a review of the evidence," *Gut*, vol. 56, no. suppl_1, pp. 1–113, Feb. 2007.
- [2] G. Iddan *et al.*, "Wireless capsule endoscopy," *Nature*, vol. 405, pp. 417–418, 2000.
- [3] B. F. Cox *et al.*, "Ultrasound capsule endoscopy: Sounding out the future," *Ann. Transl. Med.*, vol. 5, no. 9, pp. 201–201, May 2017.
- [4] J. H. Lee *et al.*, "Towards wireless capsule endoscopic ultrasound (WCEU)," in *Proc. IEEE Int. Ultrasonics Symp.*, 2014, pp. 734–737.
- [5] F. Memon *et al.*, "Capsule ultrasound device: Further developments," in *Proc. IEEE Int. Ultrasonics Symp.*, 2016, pp. 1–4.
- [6] H. S. Lay *et al.*, "Design and Simulation of a Ring-shaped linear array for micro-ultrasound capsule endoscopy," *IEEE Trans. Ultrason. Ferroelectr. Freq. Control*, vol. 65, no. 4, pp. 589–599, Apr. 2018.

- [7] X. Wang *et al.*, "Development of a mechanical scanning device with high-frequency ultrasound transducer for ultrasonic capsule endoscopy," *IEEE Trans. Med. Imag.*, vol. 36, no. 9, pp. 1922–1929, Sep. 2017.
- [8] International Electrotechnical Commission, *Medical Electrical Equipment - Part 2-37: Particular Requirements for the Basic Safety and Essential Performance of Ultrasonic Medical Diagnostic and Monitoring Equipment*, IEC 60601-2-37:2007.
- [9] "Sonopill Website," 2018. [Online]. Available: <http://www.gla.ac.uk/research/az/sonopill/>
- [10] H. S. Lay *et al.*, "Microultrasound characterisation of ex vivo porcine tissue for ultrasound capsule endoscopy," *J. Phys. Conf. Ser.*, vol. 797, Jan. 2017, Art. no. 12003.
- [11] A. B. Le Roux *et al.*, "Ex Vivo correlation of ultrasonographic small intestinal wall layering with histology in dogs," *Vet. Radiol. Ultrasound*, vol. 57, pp. 534–454, Sep. 2016.
- [12] B. F. Cox *et al.*, "Microultrasound and small bowel inflammation: Tissue phantom studies," in *Proc. IEEE Int. Ultrasonics Symp.*, 2015, pp. 1–4.
- [13] F. S. Foster *et al.*, "A history of medical and biological imaging with polyvinylidene fluoride (PVDF) transducers," *IEEE Trans. Ultrason. Ferroelectr. Freq. Control*, vol. 47, no. 6, pp. 1363–1371, Nov. 2000.
- [14] G. R. Lockwood *et al.*, "Fabrication of high frequency spherically shaped ceramic transducers," *IEEE Trans. Ultrason. Ferroelectr. Freq. Control*, vol. 41, no. 2, pp. 231–235, Mar. 1994.
- [15] G. Cummins *et al.*, "Safety evaluation of additively manufactured ingestible capsule endoscope packaging prototypes for translational trials," *IEEE Trans. Compon. Packag. Technol.*, to be published.
- [16] M. M. Swindle *et al.*, "Swine as models in biomedical research and toxicology testing," *Vet. Pathol.*, vol. 49, no. 2, pp. 344–356, 2012.
- [17] M. W. Dewhirst *et al.*, "Thermal dose requirement for tissue effect: Experimental and clinical findings," in *Proc. SPIE*, Jun. 2003, vol. 4954.
- [18] G. Ciuti *et al.*, "Capsule endoscopy: From current achievements to open challenges," *IEEE Rev. Biomed. Eng.*, vol. 4, pp. 59–72, Jan. 2011.
- [19] M. Keuchel, F. Hagenmüller, and H. Tajiri, Eds., *Video Capsule Endoscopy - A Reference Guide and Atlas*. Berlin, Germany: Springer, 2014.
- [20] R. Lu *et al.*, "Thermal safety analysis of capsule endoscope," in *Proc. 7th Int. Conf. Electron. Packag. Technol.*, 2006, pp. 1–4.
- [21] C. Chen *et al.*, "A Prototype PZT matrix transducer with low-power integrated receive ASIC for 3-D transesophageal echocardiography," *IEEE Trans. Ultrason. Ferroelectr. Freq. Control*, vol. 63, no. 1, pp. 47–59, Jan. 2016.