

Applicability of direct reuse and recycled rare earth magnets in electro-mobility

Upadhayay, Pranshu; Awais, Muhammad; Lebouc, Afef Kedous; Garbuio, Lauric; Degri, Malik; Walton, Allan; Mipo, Jean-Claude; Dubus, Jean-Marc

DOI:

[10.1109/ICRERA.2018.8566823](https://doi.org/10.1109/ICRERA.2018.8566823)

License:

Other (please specify with Rights Statement)

Document Version

Peer reviewed version

Citation for published version (Harvard):

Upadhayay, P, Awais, M, Lebouc, AK, Garbuio, L, Degri, M, Walton, A, Mipo, J-C & Dubus, J-M 2018, Applicability of direct reuse and recycled rare earth magnets in electro-mobility. in *7th International Conference on Renewable Energy Research and Applications (ICRERA 2018)*. International Conference on Renewable Energy Research and Applications (ICRERA), vol. 2018, Institute of Electrical and Electronics Engineers (IEEE), pp. 846-852, 7th international IEEE conference on renewable energy research and applications , Paris, France, 14/10/18. <https://doi.org/10.1109/ICRERA.2018.8566823>

[Link to publication on Research at Birmingham portal](#)

Publisher Rights Statement:

Checked for eligibility: 17/12/2018

© 2018 IEEE. Personal use of this material is permitted. Permission from IEEE must be obtained for all other uses, in any current or future media, including reprinting/republishing this material for advertising or promotional purposes, creating new collective works, for resale or redistribution to servers or lists, or reuse of any copyrighted component of this work in other works.

P. Upadhayay et al., "Applicability of Direct Reuse and Recycled Rare Earth Magnets in Electro-mobility," 2018 7th International Conference on Renewable Energy Research and Applications (ICRERA), Paris, France, 2018, pp. 846-852. doi: 10.1109/ICRERA.2018.8566823

General rights

Unless a licence is specified above, all rights (including copyright and moral rights) in this document are retained by the authors and/or the copyright holders. The express permission of the copyright holder must be obtained for any use of this material other than for purposes permitted by law.

- Users may freely distribute the URL that is used to identify this publication.
- Users may download and/or print one copy of the publication from the University of Birmingham research portal for the purpose of private study or non-commercial research.
- User may use extracts from the document in line with the concept of 'fair dealing' under the Copyright, Designs and Patents Act 1988 (?)
- Users may not further distribute the material nor use it for the purposes of commercial gain.

Where a licence is displayed above, please note the terms and conditions of the licence govern your use of this document.

When citing, please reference the published version.

Take down policy

While the University of Birmingham exercises care and attention in making items available there are rare occasions when an item has been uploaded in error or has been deemed to be commercially or otherwise sensitive.

If you believe that this is the case for this document, please contact UBIRA@lists.bham.ac.uk providing details and we will remove access to the work immediately and investigate.

Applicability of Direct Reuse and Recycled Rare Earth Magnets in Electro-mobility

Pranshu Upadhayay*, Afef-Kedous Lebouc, Lauric Garbuio

*Univ. Grenoble Alpes, CNRS, Grenoble INP, G2Elab,
F-38000 Grenoble, France
e-mail: pranshulink@gmail.com

Muhammad Awais, Malik Degri, Allan Walton

School of Metallurgy and Materials
University of Birmingham
Edgbaston, UK

Jean-Claude Mipo, Jean-Marc Dubus

*Valeo - Equipements Electriques Moteur
2 rue André Boulle
94000 Créteil, France

Abstract— Volatile prices and severe supply-demand issues have led to the development of a significant research area in terms of reuse and recycle of rare earth permanent magnets. Another reason for the proliferation of this research is the increased emphasis on environmental impacts of rare earth material mining which can be substantially reduced by reuse and recycling. This paper develops a methodology and analysis tool to apply direct reuse and recycled rare earth magnets into electro-mobility. Easy assembly and disassembly of permanent magnets has been presented for a permanent magnet based claw-pole machine so as to directly reuse the recovered magnets. Secondly, utilization of recycled magnets fabricated by hydrogen decrepitation in the claw-pole machine has been analyzed and compared with a machine with virgin magnets. Energy consumption of the machine with virgin and recycled magnet have been evaluated for two vehicle drive cycles and it is observed that the consumption is almost the same for the machine with both magnet types. The results indicate that new age electrical machines for this application of electro-mobility can utilize recycled magnets which in turn lead to lesser impacts on the environment due to reduced mining of new rare earth minerals.

Keywords— *claw-pole; electrical machine; electric vehicle; drive cycle; hybrid vehicle; permanent magnet; reuse; recycle*

I. INTRODUCTION

Countries around the world have started phasing out petrol and diesel vehicles through numerous governmental policies and norms [1]. The major reason for this is due to the increase in environmental pollution and amplification of temperatures which is a direct result of polluting emissions and resulting in climate change. As a consequence, automobile manufacturers in the world are extensively working towards electro-mobility (e-mobility). With the introduction of electric vehicles (EV) and hybrid electric vehicle (HEV), e-mobility seems to dominate pure combustion engine vehicles for the next few years. The electrical machines (e-machines) utilized in these EVs and HEVs majorly use rare earth (RE) permanent magnets (PM) and especially Neodymium Iron Boron (NdFeB) magnets due to their high energy density. But due to

price fluctuations and supply-demand issues of RE materials utilized in NdFeB magnets, a lot of research is being undertaken to reduce or utilize RE free magnets in PM machines. Reuse and recycle of these NdFeB magnets is also one of the ways to reduce the stress on mining of these RE materials. Research is being carried out on the recycling of these RE PMs from magnet scrap by utilizing a range of techniques [2] & [3]. Nevertheless, there are challenges in developing methodologies for reuse or recycle of magnets in electric motors due to varying motor topologies, technologies, material characteristics, proper disposal at end-of-life (EoL) and economic/environmental implications.

This study examines the applicability of direct use and recycled RE PMs in e-mobility; with the main focus on NdFeB magnets. The e-machine utilized for this is a permanent magnet based claw-pole machine. The structure of the paper is as follows. First, the methodology for direct reuse and utilization of RE PMs in the claw-pole machine is described. Second, the process of fabricating the recycled magnets using hydrogen decrepitation (HD) is elaborated and magnetic properties of recycled and virgin magnets are compared. The next section presents the design analysis of a claw-pole machine with virgin and recycled magnets. The energy consumption is also evaluated by operating the machine at two different drive cycles i.e. New European Driving Cycle (NEDC) and Worldwide Harmonized Light Vehicles Test Procedure (WLTP). The last section provides the conclusion.

II. DIRECT REUSE AND RECYCLED RARE EARTH MAGNET CONCEPT

Motors and generators in the current generation of EVs and HEVs have been engineered for best performance and lowest price, without taking into account that these machines contain large quantities of critical RE elements that need to be recovered at the EoL stage. Increasing market penetration of EVs and HEVs involves a strong demand in high performance NdFeB magnets. Considering there is no effective recovery and recycling of these magnets in place, this augments a major

issue. Hence, this section integrates this concern from the design of machine with emphasis on reusability of the permanent magnets. While being designed with reusable magnets, the machines must also meet the stringent performance and cost requirements of EVs and HEVs. The reuse/recycle methodology can be divided into two routes, which are detailed in the following section.

A. Direct Reuse methodology

Direct reuse is defined as easy assembly and disassembly of permanent magnets after EoL of the machine and reuse in other applications or reuse as an input material in the manufacturing of new magnets. At present, in the claw-pole machine, the two claw-poles are generally identical in construction related to magnet placement between the inter-claws. The inter-claws have appropriate magnet slits so as to maintain the magnets in the desired position. Fig. 1 shows the claw-poles and magnets along with the highlighted magnet slit at the end of each claw-pole so as to maintain the magnets in the desired position. Therefore, this hinders the disassembly of magnets at EoL.

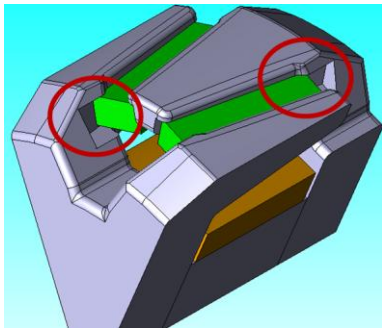

Fig. 1. Claw-poles and magnets with the appropriate magnet slit

Varnish is applied on the complete rotor assembly i.e. the claw-poles, rotor winding, magnets and shaft after manufacturing assembly is finished. In the present design, varnish is important because it helps in the mitigation of following issues:

- Vibration issues
- Corrosion issues (magnets are non-coated)
- Thermal issues (to some extent)

There are various varnish removals available in the market according to their removal capabilities and toxicity levels. Following is the list of few varnish removals as per the literature available:

- *Methylene chloride*: Toxic but very quick in removal
- *Dimethyl sulfoxide*: Medium level toxic and moderately quick in removal
- *Eco-organic solvents like terpenes from pine, citric acid, benzyl alcohol*: Less toxic but slow in removal

Fig. 2 illustrates the direct reuse methodology for assembly and disassembly of magnets in the claw-pole machine. The steps for direct reuse methodology are as follows:

During manufacturing assembly:

- a) First forged claw-pole with appropriate magnet slit is placed in the manufacturing setup.
- b) Magnets are inserted in the desired position of the inter-claw till the end of the appropriate magnet slit.
- c) It is proposed in the re-use methodology to have second forged claw-pole with complete magnet slit till the end as seen in Fig. 2. Subsequently, the second claw-pole is placed over the first claw-pole and magnets.
- d) Varnish is applied to the complete rotor assembly.

At EoL, i.e. during disassembly:

- a) Varnish remover is applied on the complete rotor assembly. Depending upon the needs, chemical based or eco-friendly varnish remover can be applied.
- b) The rotor is subjected to Curie temperature for 30 seconds so as to demagnetize the magnets before disassembly. This temperature treatment also helps in loosening of the varnish.
- c) Push the magnet out through the complete magnet slit.

B. Utilization of direct recycled magnets in electrical machine

Direct recycle is defined as utilizing directly recycled permanent magnets in designing of new electrical machines developed for automotive applications. Direct recycling of permanent magnets refer to the treatment of scrap magnets as a raw material for the production of new magnets, but using novel techniques such as HD, hydrogenation disproportionation desorption recombination (HDDR) processing, and many more, to give new, ready-to-use, magnetic materials or a new master alloy that can be processed using existing magnet production facilities. Literature has shown that the magnetic properties of recycled magnets may differ from 3% to 20% when compared to that of the original magnetic material used for the production of new magnets. Consequently, with the decrease in magnetic properties, the performance of electrical machine also changes. Hence, the direct recycle methodology for design of an electrical machine (claw-pole type) has been proposed in Fig. 3.

The steps for direct recycle methodology are as follows:

- a) Existing electrical machine designs utilizing new/virgin permanent magnets are analyzed and the performance for these machines are recorded in a dataset.
- b) In the electrical machine design of step 1, recycled magnet material properties are used for analysis and performance parameters are recorded in another dataset.
- c) The machine performances with new/virgin magnet and recycled magnets are compared using data analysis.
- d) Finally the machine design is optimized so as to achieve the best performance utilizing the recycled magnet properties.
- e) Evaluation of energy and fuel consumption to check for economic viability.

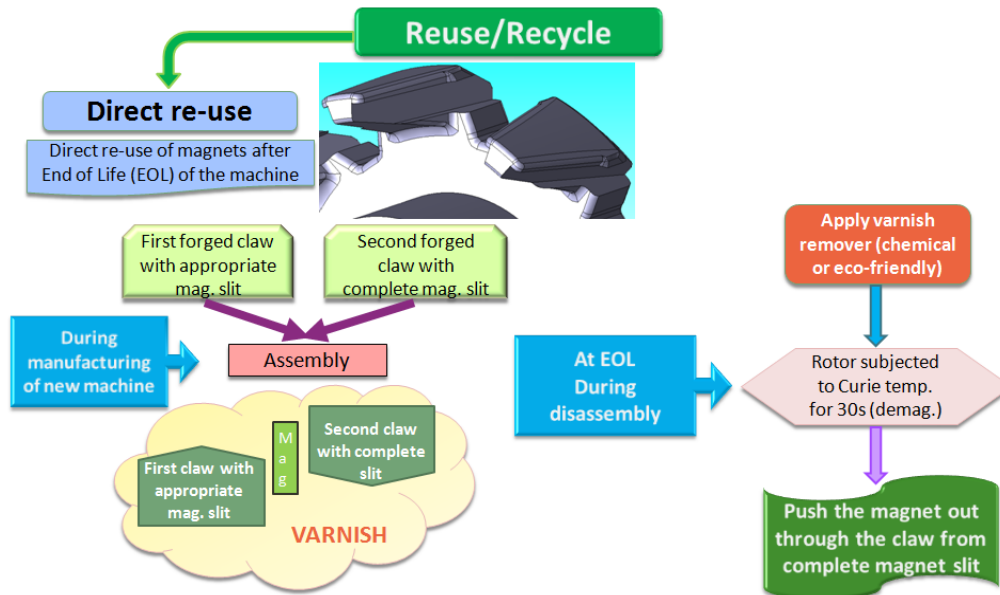

Fig. 2. Direct reuse methodology for assembly and disassembly of magnets in claw-pole machine

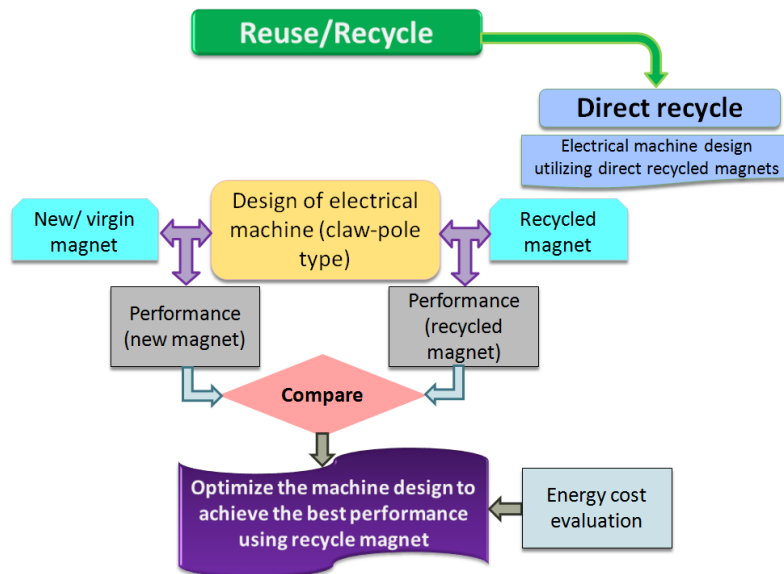

Fig. 3. Direct recycle methodology for the design of electrical machine (claw-pole type)

III. RECYCLED MAGNET FABRICATION USING HYDROGEN DEPREPITATION

Researchers at the University of Birmingham have shown that hydrogen can be used to separate NdFeB magnets from hard disk drive scrap [4]. In this work, hydrogen is used to extract NdFeB magnets from automotive motor scrap in the form of hydrogenated NdFeB powder. This powder was then purified by various separation techniques (e.g. magnetic separation and sieving) for production of sintered magnets with good magnetic properties. However, the polymeric coating on some of the magnets used in drive motors could not be fully removed by these techniques. Previous work has shown that carbon has a negative influence on the magnetic properties; however the rare earth content in the alloy

influences the threshold where the carbon has a limited effect on the coercivity [5].

In this work, the magnets were extracted from drive motors of EoL vehicles and demagnetized by heating to 350 °C in the air and the polymeric coating was removed by grinding the surfaces followed by HD. The HD powder was then milled under Argon to below 45 μm particle size using knife mill after the addition of 5at% freshly prepared neodymium hydride (NdH_{2.7}). Finally the powder was aligned in 1.3 T field using permeameter, iso-statically pressed into a green compact and sintered at 1080 °C for 1 hour under vacuum (~10⁻⁵ mbar). These recycled magnets were then compared in terms of magnetic properties and density to compare with commercially produced sintered N42SH

magnets. Fig. 4 shows the schematic of possible re-processing routes as developed in ref [4].

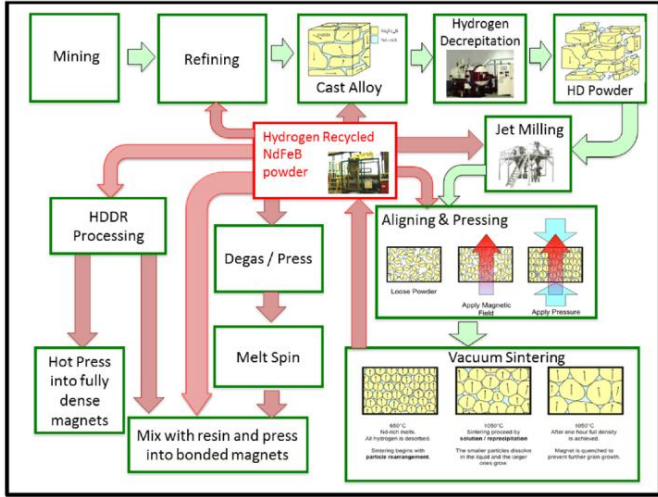

Fig. 4. Schematic of possible re-processing routes. Green boxes show primary route for manufacturing a sintered NdFeB magnet. Red boxes and arrows demonstrate where the hydrogen extracted powder can be fed back in to recycle the material [4]

Fig. 5 and Fig. 6 depict the measured magnetization BH curve of virgin N42SH and recycled magnet at 25 °C and 150 °C temperature respectively.

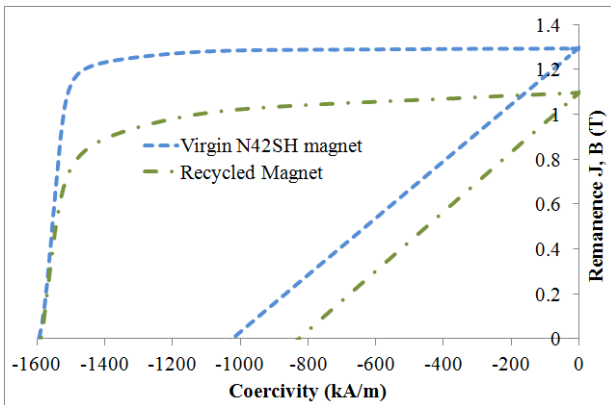

Fig. 5. Measured magnetization BH curve of virgin N42SH and recycled magnet at 25 °C temperature

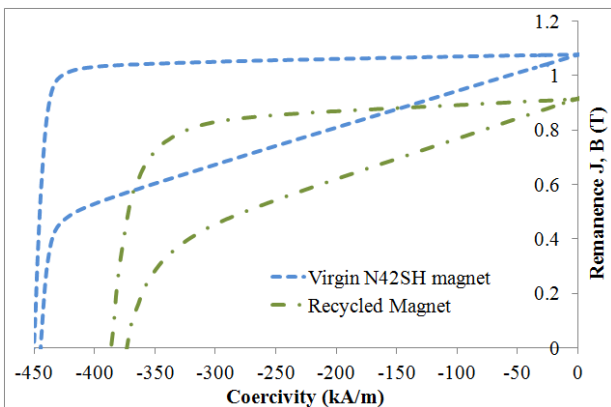

Fig. 6. Measured magnetization BH curve of virgin N42SH and recycled magnet at 150 °C temperature

Table I. illustrates the magnetic properties i.e. remanence (B_r) and coercivity (H_{cb}) of virgin and recycled magnets at 25 and 150 °C temperatures. It can be observed that the percentage difference in B_r @ 25 °C is 15.4 % and @ 150 °C is 14.8 %, and percentage difference in H_{cb} @ 25 °C is 19.0 % and @ 150 °C is 15.7 %. Hence, it is pertinent to check machine performance at higher temperatures for recycled magnets as reduction in H_{cb} is high and this could lead to irreversible demagnetization of magnets.

TABLE I. MAGNETIC PROPERTIES OF VIRGIN AND RECYCLED MAGNETS AT DIFFERENT TEMPERATURES

	Temperature	Virgin magnet	Recycled magnet	% diff.
B_r (T)	@ 25 °C	1.30	1.10	15.4
	@ 150 °C	1.08	0.92	14.8
H_{cb} (kA/m)	@ 25 °C	-1025	-830	19.0
	@ 150 °C	-445	-375	15.7

IV. DESIGN ANALYSIS WITH VIRGIN AND RECYCLED MAGNET

The PM based claw-pole machine utilized in this study is developed for a 48 V mild hybrid starter-generator automotive application. One of the advantages of utilizing PMs in a claw-pole machine is to obtain high torque during constant torque region and this study is highlighted in ref [6] & [7]. Utilization of recycled PMs in electrical machines is now being researched upon so as to explore the advantages of reuse/recyclability, i.e. less pressure on mining, fewer environmental impacts and small amount of supply-demand problems [8]. In this section, first the comparison in torque-speed at peak performance with virgin and recycled magnets is presented and secondly, energy consumption is evaluated for NEDC and WLTP drive cycles.

A. Performance comparison with virgin and recycled magnets

Virgin magnets used in this study are commercially available N42SH PMs with the magnetic properties as listed in Table I. Similarly, recycled magnets utilized are developed in a lab scale as described in Section III and with magnetic properties as listed in Table I. Three dimensional (3-D) finite element (FE) analysis and MATLAB programming was carried out to obtain the machine performance in the complete torque-speed envelop. Fig. 7 illustrates the comparison of torque-speed curve with virgin and recycled magnets at peak performance. It can be observed that there is a reduction of 5.26 % in peak torque during constant torque region, and almost negligible change in torque in constant power region. This decrease is mainly due to the reduction in recycled magnet's magnetic performance and can be overcome by optimizing the machine design.

B. Energy consumption evaluation with drive cycle incorporation

Energy consumption for a reference drive cycle requires performance parameters of the machine for the complete torque vs. speed envelop. As a result, efficiency map of the motor needs to be evaluated so as to acquire the precise torque and efficiency points for the corresponding speed values in the

reference drive cycle. The methodology to obtain the energy consumption by the machine can be seen in Fig. 8 and is studied in detail in ref. [9].

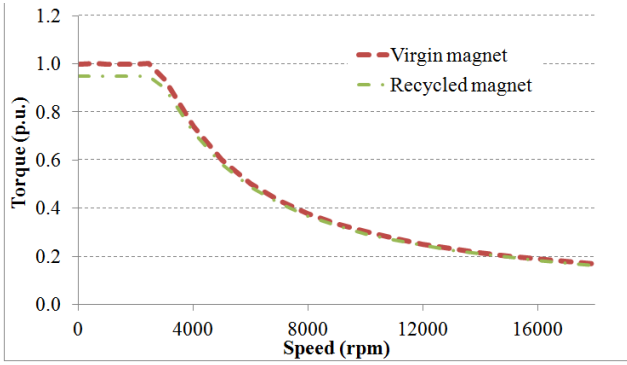

Fig. 7. Torque-speed curve at peak performance with virgin and recycled magnets for the PM based claw-pole machine

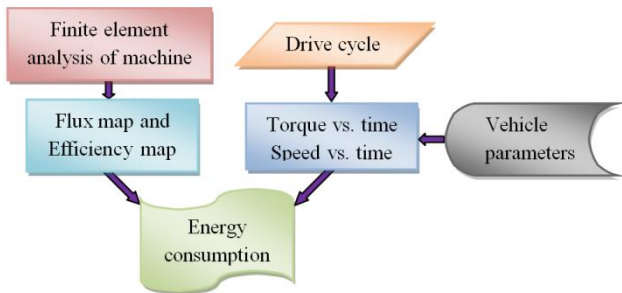

Fig. 8. Flow diagram for energy evaluation methodology [9]

Fig. 9 shows the efficiency map of the machine with recycled magnets in motor and generator mode.

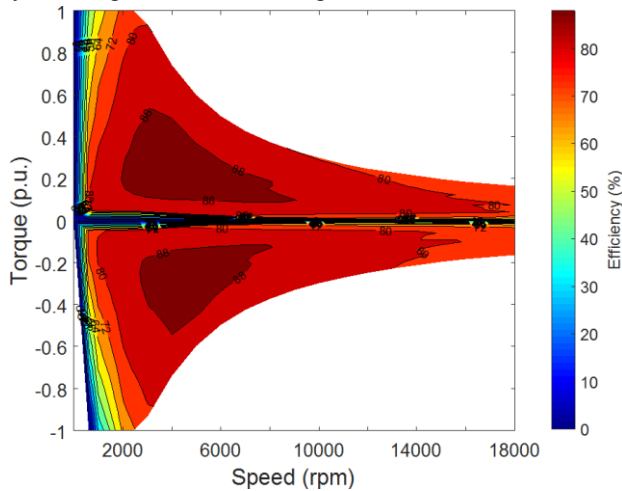

Fig. 9. Efficiency map of the machine with recycled magnets

To evaluate fuel consumption of the machine it is required to analyze the complete system simulation with an internal combustion engine (ICE), clutch and gear mechanism, etc. Hence, in this section it is assumed that the machine performs in pure EV mode and is coupled to the wheels by gear transmission. It is assumed that the vehicle is a compact 2-seater city car with the vehicle parameters as follows: vehicle weight = 500 kg, density of air = 1.25 kg/m³, frontal area = 1 m², drag coefficient = 0.3, coefficient of rolling resistance =

0.007, tyre radius = 0.273 m and gear ratio = 10:1 [10].

Two different drive cycles are utilized in this section for energy consumption evaluation viz. NEDC and WLTP. The NEDC and WLTP drive cycles can be seen in Fig. 10 (a) and (b) respectively.

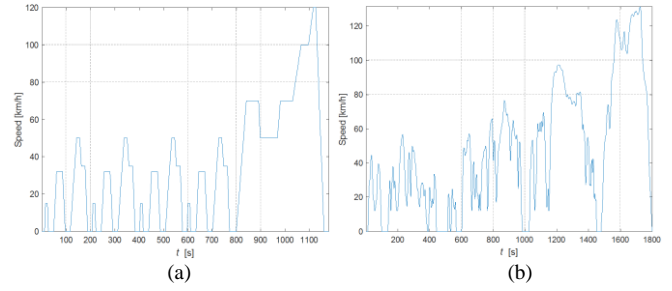

Fig. 10. (a) NEDC drive cycle (b) WLTP drive cycle

Consequently, using the vehicle parameters and NEDC & WLTP cycles, the operating points of both the drive cycles can be obtained by utilizing the flow diagram as in Fig. 8. The gear ratio of 10:1 is selected due to the fact that all the operating points of NEDC and WLTP cycle are placed nearly below the continuous performance region of the machine. This is because the machine should operate in its thermal equilibrium continuously for the complete drive cycle. Fig. 11 depicts the torque-speed envelopes of the machine for peak and continuous performance along with NEDC operating points. Similarly, Fig. 12 shows the torque-speed envelopes of the machine for peak and continuous performance along with WLTP operating points.

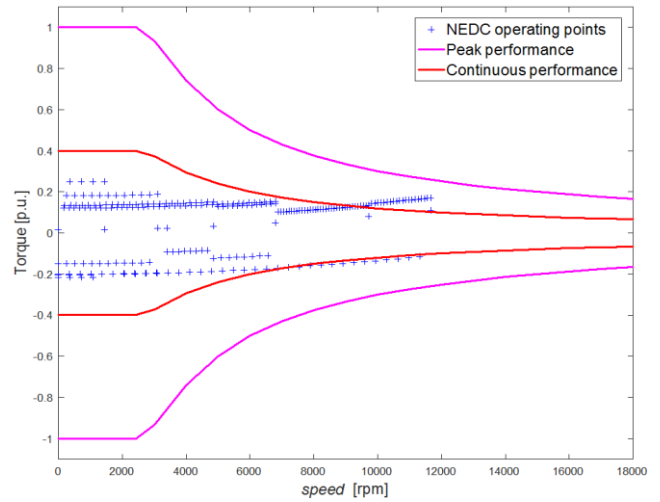

Fig. 11. Torque-speed envelop of the machine with NEDC operating points

As per the flow diagram in Fig. 8; the torque vs. speed profile and efficiency map are employed together to get the energy consumed by the machine during the lifetime of 10 years with 2 hours of daily operation. The energy consumption can be calculated as:

$$E_c = \int_0^t E(t) dt \quad (1)$$

where, E_c is total energy consumed, $E(t)$ is energy input as function of time and t is time.

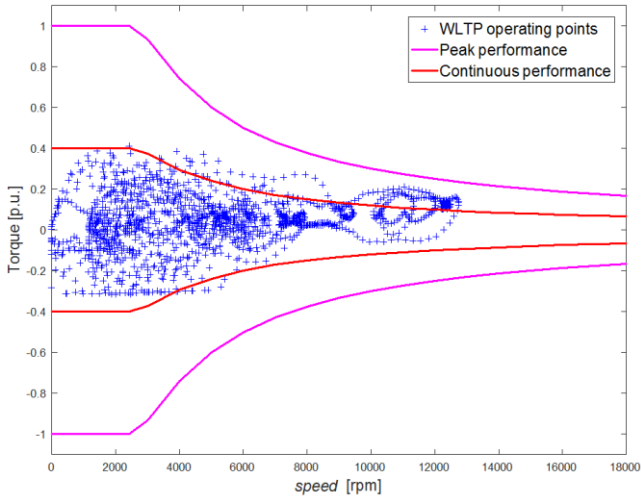

Fig. 12. Torque-speed envelop of the machine with WLTP operating points

The harmonized electricity price for Europe region is considered as 0.22 €/kWh [11]. As a result, the energy consumed by the machine with virgin and recycled magnets for NEDC and WLTP drive cycle with the above assumed lifetime is listed in Table II. It can be observed that the percentage difference in the energy cost with NEDC and WLTP drive cycle is 0.51 % and 0.38 % respectively. Hence, it can be concluded that the machine performance with recycled magnets in different drive cycles at various operating points is almost the same.

TABLE II. ENERGY AND ENERGY COST WITH VIRGIN & RECYCLED MAGNETS FOR NEDC & WLTP DRIVE CYCLE

Magnet type	Energy (kWh)		Energy cost (€)	
	NEDC	WLTP	NEDC	WLTP
Virgin magnet	9619	16353	2116	3598
Recycled magnet	9669	16415	2127	3611
	% difference			
	0.51	0.38	0.51	0.38

C. Permanent magnet demagnetization study

PM demagnetization at higher temperature operation for recycled magnets is also important as the H_{cb} for recycled magnets is low. In this section, first the machines' developed torque at base speed with peak current would be observed. Then as a worst case scenario, maximum field current and only negative d-axis current (I_d) current at 150 °C temperature would be injected and the magnet demagnetization would be observed. This demagnetized magnet would again be used to calculate the developed torque so as to compare the torque with a non-demagnetized PM and demagnetized PM. This procedure would be carried out for the machine with virgin and recycled magnets. In Fig. 13 the demagnetized virgin magnet with $I_d = -325$ A and q-axis current (I_q) = 0 A can be observed.

It can be observed that at PM corners the magnetization is above the knee point of the BH curve and only small area seems to be demagnetized. Fig. 14 depicts the developed torque with non-demagnetized and demagnetized virgin PMs. It can be observed that there is almost no change in the torque

and hence the machine is capable to handle the worst case scenario without being derated.

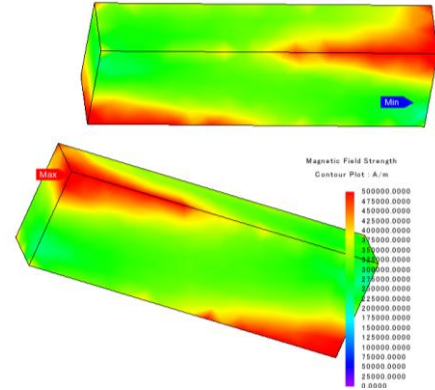

Fig. 13. Demagnetization of virgin magnets at $I_d = -325$ A and $I_q = 0$ A

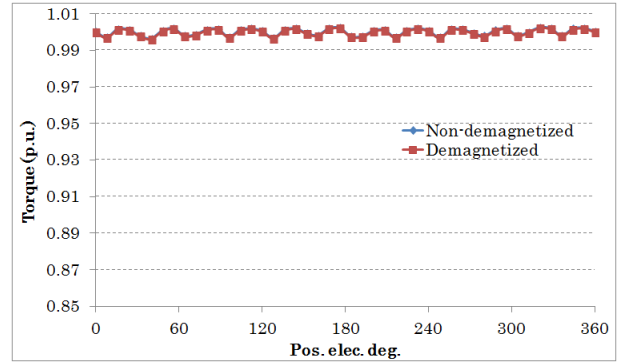

Fig. 14. Developed torque with non-demagnetized & demagnetized virgin PMs

Similarly, in Fig. 15 the demagnetized recycled magnet with $I_d = -325$ A and $I_q = 0$ A can be observed. The recycled PM gets demagnetized more towards the corners and moves inward as compared to virgin PMs as the H_{cb} for recycled PMs is around 15-19 % lower than compared to virgin PMs. The developed torque with non-demagnetized and demagnetized recycled PMs in the machine can be seen in Fig. 16.

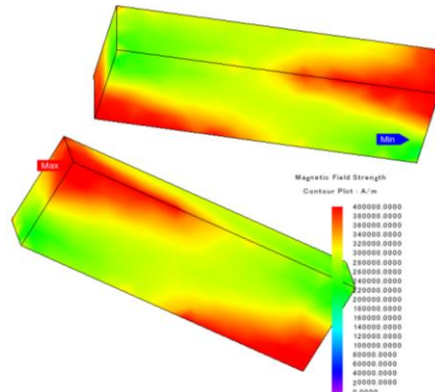

Fig. 15. Demagnetization of recycled magnets at $I_d = -325$ A and $I_q = 0$ A

It can be observed that the developed torque is reduced by 1.6 % for demagnetized PMs as compared to non-demagnetized PMs. The percentage reduction in torque is very less as the PMs are not the main source of induction in this machine but still the e-machine design needs to be taken care

for this reduction in new e-machine designs. This reduction can easily be surpassed by systematic optimization of the e-machine so as to achieve the performance and as well as take into account magnet demagnetization effects.

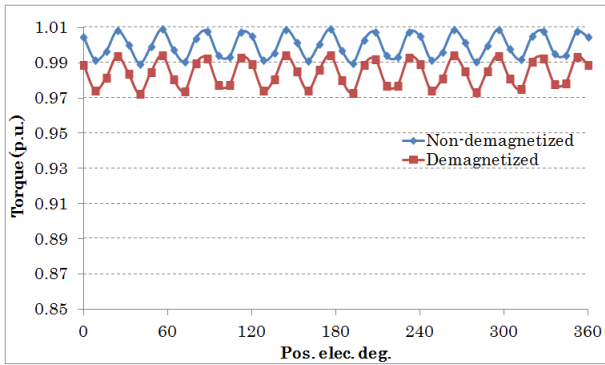

Fig. 16. Developed torque with non-demagnetized & demagnetized recycled PMs

The above investigation gives insight upon the utilization of recycled magnets in new age electrical machines of this application for these power ratings. The claw-pole machine could be easily optimized to obtain the little reduction in energy and torque-speed performance to obtain results equivalent to a machine with virgin magnets. The price of recycled magnets is assumed to be lesser than virgin magnets, hence providing cost benefits for the machine. Even if the price is similar than virgin magnets, the environmental impact of recycled magnets is much lower due to reduced mining activities. Life cycle assessment of NdFeB magnet production by magnet-to-magnet recycling for EV motors shows that PMs fabricated from magnet scrap can have up to 64-96 % lower environmental impacts, depending on the specific impact categories under investigation [12].

V. CONCLUSION

In this research work, direct reuse methodology and employment of recycled magnets in a PM based claw-pole machine for e-mobility has been investigated. The direct reuse methodology is useful in extracting the PMs easily after end-of-life of the machine and utilized for other applications or sent for re-processing to obtain recycled magnets. The direct recycle methodology uses recycled magnets in existing machine design to evaluate the performance and energy cost for NEDC and WLTP drive cycle. It has been observed that the energy cost with virgin and recycled magnets for machine operation in NEDC and WLTP drive cycles is very similar and the percentage difference is only in the range of 0.38 % to 0.51 %. This provides the motivation of utilizing recycled magnets for advanced and new PM claw-pole machines for HEV applications. The environmental impact of utilizing recycled magnets would be low and hence making the electrical machine more sustainable in nature. Future work is planned with the experimental utilization of recycled PMs in

claw-pole machine design.

Acknowledgment

The research leading to these results has received funding from European Community's Horizon 2020 Programme ([H2020/2014-2019]) under Grant Agreement no. 674973 (MSCA-ETN DEMETER). This publication reflects only the author's view, exempting the Community from any liability. Project website: <http://etn-demeter.eu/>.

References

- [1] Countries are announcing plans to phase out petrol and diesel cars. Is yours on the list? [Online] Available: <https://www.weforum.org/agenda/2017/09/countries-are-announcing-plans-to-phase-out-petrol-and-diesel-cars-is-yours-on-the-list/>
- [2] K. Binnemans, P. T. Jones, B. Blanpain, T. V. Gerven, Y. Yang, A. Walton & M. Buchert, "Recycling of rare earths: a critical review", *Journal of Cleaner Production*, vol. 51, no. 15, pp. 1-22, July 2013.
- [3] Y. Yang, A. Walton, R. Sheridan, K. Güth, R. Gauß, O. Gutfleisch, M. Buchert, B. M. Steenari, T. V. Gerven, P. T. Jones & K. Binnemans, "REE Recovery from End-of-Life NdFeB Permanent Magnet Scrap: A Critical Review", *Journal of Sustainable Metallurgy*, vol. 3, no. 1, pp. 122-149, March 2017.
- [4] A. Walton, Han Yi, N. A. Rowson, J. D. Speight, V. S. J. Mann, R. S. Sheridan, A. Bradshaw, I. R. Harris, A. J. Williams "The use of hydrogen to separate and recycle neodymium iron boron-type magnets from electronic waste," *Journal of Cleaner Production*, vol. 104, no. 1, pp. 236-241, October 2015.
- [5] L. U. Lopes, M. A. Carvalho, R. S. Chaves, M. P. Trevisan, Paulo A. P. Wendhausen, H. Takiishi, "Study of Carbon Influence on Magnetic Properties of Metal Injection Molding Nd-Fe-B Based Magnets," *Materials Science Forum*, vol. 727-728, pp. 124-129, August 2012.
- [6] P. Upadhayay, A. Kedous-Lebouc, L. Garbuio, J. C. Mipo, J. M. Dubus, "Design & comparison of a conventional and permanent magnet based claw-pole machine for automotive application," 15th International Conference on Electrical Machines, Drives and Power Systems (ELMA) 2017, pp. 1-5, June 2017.
- [7] P. Upadhayay, A. Kedous-Lebouc, L. Garbuio, J. C. Mipo, J. M. Dubus, "Impact of claw-pole geometry variations on the performance of machine used in automotive application," IECON 2017 - 43rd Annual Conference of the IEEE Industrial Electronics Society, pp. 1990-1995, October/November 2017.
- [8] M. Kimiabeigi, R. S. Sheridan, J. D. Widmer, A. Walton, M. Farr, B. Scholes, and I. R. Harris, "Production and Application of HPMS Recycled Bonded Permanent Magnets for a Traction Motor Application," *IEEE Trans. on Industrial Electronics*, vol. 65, no. 5, pp. 3795-3804, May 2018.
- [9] P. Upadhayay, A. G. Garcia, Z. Li, A. K. Jha, P. O. Rasmussen, A. Kedous-Lebouc, J. C. Mipo "Evaluation of Energy Cost Index for an Electric Vehicle Motor over a particular Drive Cycle with Recycled Magnet Concept," 23rd International Conference on Electrical Machines (ICEM) 2018, pp. 1-6, September 2018.
- [10] P. Lazari, J. Wang, and L. Chen, "A Computationally Efficient Design Technique for Electric-Vehicle Traction Machines," *IEEE Trans. on Industry Applications*, vol. 50, no. 5, pp. 3203-3213, Sep.-Oct. 2014.
- [11] Electricity price statistics, http://ec.europa.eu/eurostat/statistics-explained/index.php/Electricity_price_statistics
- [12] H. Jin, P. Afiuny, S. Dove, G. Furlan, M. Zakotnik, Y. Yih, and J. W. Sutherland, "Life Cycle Assessment of Neodymium-Iron-Boron Magnet-to-Magnet Recycling for Electric Vehicle Motors," *Environ. Sci. Technol. Journal*, 52 (6), pp 3796-3802, 2018.