

Brauer trees of unipotent blocks

Rouquier, Raphaël; Craven, David; Dudas, Olivier

DOI:
[10.4171/JEMS/978](https://doi.org/10.4171/JEMS/978)

License:
None: All rights reserved

Document Version
Peer reviewed version

Citation for published version (Harvard):
Rouquier, R, Craven, D & Dudas, O 2020, 'Brauer trees of unipotent blocks', *Journal of the European Mathematical Society*, vol. 22, no. 9, pp. 2821-2877. <https://doi.org/10.4171/JEMS/978>

[Link to publication on Research at Birmingham portal](#)

Publisher Rights Statement:

This document is the Author Accepted Manuscript version of a published work which appears in its final form in *Journal of the European Mathematical Society*, copyright © 2020 EMS Publishing House. All rights reserved. The final Version of Record can be found at: <https://doi.org/10.4171/JEMS/978>

General rights

Unless a licence is specified above, all rights (including copyright and moral rights) in this document are retained by the authors and/or the copyright holders. The express permission of the copyright holder must be obtained for any use of this material other than for purposes permitted by law.

- Users may freely distribute the URL that is used to identify this publication.
- Users may download and/or print one copy of the publication from the University of Birmingham research portal for the purpose of private study or non-commercial research.
- User may use extracts from the document in line with the concept of 'fair dealing' under the Copyright, Designs and Patents Act 1988 (?)
- Users may not further distribute the material nor use it for the purposes of commercial gain.

Where a licence is displayed above, please note the terms and conditions of the licence govern your use of this document.

When citing, please reference the published version.

Take down policy

While the University of Birmingham exercises care and attention in making items available there are rare occasions when an item has been uploaded in error or has been deemed to be commercially or otherwise sensitive.

If you believe that this is the case for this document, please contact UBIRA@lists.bham.ac.uk providing details and we will remove access to the work immediately and investigate.

BRAUER TREES OF UNIPOTENT BLOCKS

DAVID A. CRAVEN, OLIVIER DUDAS, AND RAPHAËL ROUQUIER

ABSTRACT. In this paper we complete the determination of the Brauer trees of unipotent blocks (with cyclic defect groups) of finite groups of Lie type. These trees were conjectured by the first author in [19]. As a consequence, the Brauer trees of principal ℓ -blocks of finite groups are known for $\ell > 71$.

CONTENTS

1. Introduction	2
2. Notation	5
3. Modular representations and geometry	7
3.1. Deligne–Lusztig varieties	7
3.1.1. Unipotent blocks	7
3.1.2. Harish-Chandra induction and restriction	8
3.1.3. Complex of cohomology and Frobenius action	10
3.1.4. Simple modules in the cohomology of Deligne–Lusztig varieties	11
3.2. Compactifications	12
3.3. Steinberg representation	14
3.4. Coxeter orbits	15
3.5. Generic theory	16
3.5.1. Reflection data	16
3.5.2. d -Harish-Chandra theory	17
4. Unipotent blocks with cyclic defect groups	18
4.1. Blocks with cyclic defect groups	18
4.1.1. Brauer trees and folding	18
4.1.2. Brauer tree of a block with cyclic defect	18
4.1.3. Folding	19
4.2. Structure of unipotent blocks with cyclic defect groups	19
4.2.1. Centre	20
4.2.2. Local subgroups and characters	21

Date: January 25, 2018.

The first author is supported by a Royal Society Research Fellowship. The second author gratefully acknowledges financial support by the ANR, Project No ANR-16-CE40-0010-01. The third author is partly supported by the NSF (grant DMS-1161999) and by a grant from the Simons Foundation (#376202).

4.2.3.	Genericity	22
4.2.4.	Determination of the trees	24
4.3.	Properties of the trees	25
4.3.1.	Harish-Chandra branches	25
4.3.2.	Real stem	27
4.3.3.	Exceptional vertex	27
4.3.4.	In the stable category	28
4.3.5.	Coxeter orbits	28
4.4.	Summary of the algebraic methods	32
5.	Determination of the trees	33
5.1.	Groups of type E_7	34
5.1.1.	$d = 14$	34
5.1.2.	$d = 9$	35
5.1.3.	$d = 10$	36
5.2.	Groups of type E_8	36
5.2.1.	$d = 9$	36
5.2.2.	$d = 12$	37
5.2.3.	$d = 18$	37
5.2.4.	$d = 15$	41
5.2.5.	$d = 20$	43
5.2.6.	$d = 24$	47
5.3.	Other exceptional groups	49
5.3.1.	$E_6(q)$, ${}^2E_6(q)$, $F_4(q)$ and $G_2(q)$	49
5.3.2.	${}^2B_2(q^2)$ and ${}^2G_2(q^2)$	50
5.3.3.	${}^2F_4(q^2)$	50
Appendix A.	Brauer trees for $E_7(q)$ and $E_8(q)$	53
References		59

1. INTRODUCTION

A basic problem in the modular representation theory of finite groups is to determine decomposition matrices. The theory of blocks with cyclic defect groups that originated with Brauer [5] and was completed by Dade [21], encodes the Morita equivalence class of a block in a planar embedded tree. Its vertices correspond to ordinary irreducible representations, its edges to modular irreducible representations, and the edges containing a given vertex correspond to the composition factors of a modular reduction of the ordinary irreducible representation.

The prospect of determining all Brauer trees associated to finite groups is a fundamental challenge in modular representation theory. In 1984, Feit [32, Theorem 1.1] proved that, up to *unfolding* — broadly speaking, taking a graph consisting of several copies of a given Brauer tree and then identifying all exceptional vertices — the

collection of Brauer trees of all finite groups coincides with that of the quasisimple groups.

For alternating groups and their double covers, the Brauer trees are known [62], and for all but the two largest sporadic groups all Brauer trees are known (see [50] for most of the trees). The remaining quasisimple groups, indeed the ‘majority’ of quasisimple groups, are groups of Lie type $G(q)$: if ℓ is a prime dividing $|G(q)|$ then either $\ell \nmid q$ or $\ell \mid q$ — in the latter case, for there to be an ℓ -block with cyclic defect group we must have that $G/Z(G) = \mathrm{PSL}_2(\ell)$ and the Brauer tree is a line.

Thus the major outstanding problem is to determine the Brauer trees of ℓ -blocks of groups of Lie type when $\ell \nmid q$. Conjecturally, all such blocks are Morita equivalent to unipotent blocks ("Jordan decomposition of blocks"). It is known that every block is Morita equivalent to an isolated block of a possibly non-connected reductive group [1], and the case of isolated blocks with cyclic defect is currently under investigation by the first author and Radha Kessar.

Here we complete the determination of the Brauer trees of *unipotent blocks* of $G(q)$. We determine in particular the trees occurring in principal blocks. Our main theorem is the following.

Theorem 1.1. *Let G be a finite group of Lie type and let ℓ be a prime distinct from the defining characteristic. If B is a unipotent ℓ -block of G with cyclic defect groups then the planar-embedded Brauer tree of B is known. Furthermore, the labelling of the vertices by unipotent characters in terms of Lusztig’s parametrization is known.*

Theorem 1.1 has the following corollary.

Corollary 1.2. *Let G be a finite group with cyclic Sylow ℓ -subgroups. If $\ell \neq 29, 41, 47, 59, 71$, then the (unparametrized) Brauer tree of the principal ℓ -block of G is known.*

Note that a solution of the Jordan decomposition conjecture for isolated blocks with cyclic defect would extend the previous corollary to all blocks with cyclic defect groups of all finite groups (for $\ell > 71$ so that no sporadic groups are involved).

A basic method to determine decomposition matrices of finite groups is to induce projective modules from proper subgroups. In the case of modular representations of finite groups of Lie type in non-defining characteristic, Harish-Chandra induction from standard Levi subgroups has similarly been a very useful tool to produce projective modules. Here, we introduce a new method, based on the construction, via Deligne–Lusztig induction, of bounded complexes of projective modules with few non-zero cohomology groups. This is powerful enough to allow us to determine the decomposition matrices of all unipotent blocks with cyclic defect groups of finite groups of Lie type.

In [30], the second and third authors used Deligne–Lusztig varieties associated to Coxeter elements to analyse representations modulo ℓ , where the order d of q modulo

ℓ is the Coxeter number. Here, we consider cases where that order is not the Coxeter number, but we use nevertheless the geometry of Coxeter Deligne–Lusztig varieties, as they are the best understood, and have certain remarkable properties not shared by other Deligne–Lusztig varieties.

Our main result is the proof of the first author’s conjecture [19], in the case of blocks with cyclic defect groups. That conjecture is about the existence of a perverse equivalence with a specific perversity function. Using the algorithm that determines the Brauer tree from the perversity function [17], the first author had proposed conjectural Brauer trees and proved that his conjecture held in many cases. We complete here the proof of that conjecture.

The methods we use for determining the Brauer trees are a combination of standard arguments and more recent methods developed in [28, 29, 30]. We start with the subtrees corresponding to various Harish-Chandra series, giving a disjoint union of lines providing a first approximation of the tree. The difficulty lies in connecting those lines with edges labelled by cuspidal modules. Many possibilities can be ruled out by looking at the degrees of the characters and of some of their tensor products. These algebraic methods have proved to be efficient for determining most of the Brauer trees of unipotent blocks (see for instance [48, 49]), but were not sufficient for groups of type E_7 and E_8 . We overcome this problem by using the mod- ℓ cohomology of Deligne–Lusztig varieties and their smooth compactifications. This is done by analysing well-chosen Frobenius eigenspaces on the cohomology complexes of these varieties and extracting

- projective covers of cuspidal modules, giving the missing edges in the tree,
- Ext-spaces between simple modules, yielding the planar-embedded tree.

This strategy requires some control on the torsion part of the cohomology groups, and for that reason we must focus on small-dimensional Deligne–Lusztig varieties only (often associated with Coxeter elements).

The simplest statement is obtained when the order of a Coxeter torus and the order of proper Levi subgroups are prime to ℓ . In that case, we are able to determine part of the tree (Corollary 4.23). The most delicate part is the last statement below. It involves the planar embedding of the tree and unipotent representations corresponding to conjugate eigenvalues of the Frobenius. We show that

- there is a line L starting with the trivial module $L_0 = K$, continuing with r (= \mathbb{F}_q -rank of the group) principal series unipotent representations L_1, \dots, L_r , the last of which L_r is the Steinberg representation St .
- St is connected to the non-unipotent (usually exceptional) vertex by the edge corresponding to the modular Steinberg module St_ℓ .
- If a vertex not in L is connected to L by an edge, then it must be connected to the Steinberg representation or the non-unipotent vertex.

- The (irreducible) representation V corresponding to the part of the r -th cohomology group with compact support of the Coxeter Deligne-Lusztig variety on which the Frobenius acts by an eigenvalue congruent to q^r modulo ℓ is attached to St by an edge. That edge comes after the edge connecting St to L_{r-1} and before the edge connecting St to the non-unipotent vertex, in the cyclic ordering of edges around St .

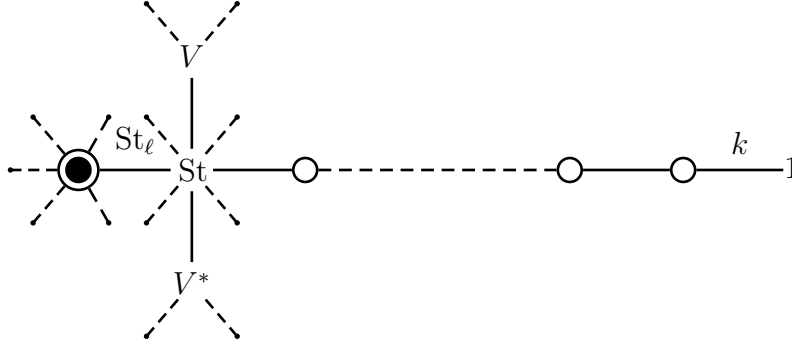

We now briefly describe the structure of the article. Section 3 is devoted to general results on unipotent blocks of modular representations of finite groups of Lie type, using algebraic and geometrical methods. In Section 4, we deal specifically with unipotent blocks with cyclic defect groups. After recalling in §4.1 the basic theory of Brauer trees, we consider in §4.2 the local structure of the blocks. In §4.3, we establish general properties of the trees, and in particular we relate properties of the complex of cohomology of Coxeter Deligne–Lusztig varieties with properties of the Brauer tree. A key result is Lemma 4.20 about certain perfect complexes for blocks with cyclic defect groups with only two non-zero rational cohomology groups. In §5 we complete the determination of the trees, which are collected in the appendix. The most complicated issues arise from differentiating the cuspidal modules $E_8[\theta]$ and $E_8[\theta^2]$ when $d = 18$ (§5.2.3) and ordering cuspidal edges around the Steinberg vertex for $d = 20$ (§5.2.5).

Acknowledgements: We thank Cédric Bonnafé, Frank Lübeck and Jean Michel for some useful discussions, and Gunter Malle for his comments on a preliminary version of the manuscript.

2. NOTATION

Let R be a commutative ring. Given two elements a and r of R with r prime, we denote by a_r the largest power of r that divides a . If M is an R -module and R' is a commutative R -algebra, we write $R'M = R' \otimes_R M$.

Let ℓ be a prime number, \mathcal{O} the ring of integers of a finite extension K of \mathbb{Q}_ℓ and k its residue field. We assume that K is large enough so that the representations

of finite groups considered are absolutely irreducible over K , and the Frobenius eigenvalues on the cohomology groups over K considered are in K .

Given a ring A , we denote by $A\text{-mod}$ the category of finitely generated A -modules, by $A\text{-proj}$ the category of finitely generated projective A -modules and by $\text{Irr}(A)$ the set of isomorphism classes of simple A -modules. When A is a finite-dimensional algebra over a field, we identify $K_0(A\text{-mod})$ with $\mathbb{Z}\text{Irr}(A)$ and we denote by $[M]$ the class of an A -module M . Given two complexes C and C' of A -modules, we denote by $\text{Hom}_A^\bullet(C, C') = \bigoplus_{i,j} \text{Hom}_A(C^i, C'^j)$ the total Hom-complex.

Let Λ be either k , \mathcal{O} or K and let A be a symmetric Λ -algebra: A is finitely generated and free as a Λ -module and A^* is isomorphic to A as an (A, A) -bimodule. An A -lattice is an A -module that is free of finite rank as a Λ -module.

Given $M \in A\text{-mod}$, we denote by P_M a projective cover of M . We denote by $\Omega(M)$ the kernel of a surjective map $P_M \twoheadrightarrow M$ and we define inductively $\Omega^i(M) = \Omega(\Omega^{i-1}(M))$ for $i \geq 1$, where $\Omega^0(M)$ is a minimal submodule of M such that $M/\Omega^0(M)$ is projective. Note that $\Omega^i(M)$ is unique up to isomorphism. When M is an A -lattice, we define $\Omega^{-i}(M)$ as $(\Omega^i(M^*))^*$, using the right A -module structure on $M^* = \text{Hom}_\Lambda(M, \Lambda)$.

We denote by $\text{Ho}^b(A)$ and $D^b(A)$ the homotopy and derived categories of bounded complexes of finitely generated A -modules. Given a bounded complex of finitely generated A -modules C , there is a complex C^{red} of A -modules, unique up to (non-unique) isomorphism, such that C is homotopy equivalent to C^{red} and C^{red} has no non-zero direct summand that is homotopy equivalent to 0.

Suppose that $\Lambda = k$. We denote by $A\text{-stab}$ the stable category of $A\text{-mod}$, i.e., the additive quotient by the full subcategory of finitely generated projective A -modules. Note that the canonical functor $A\text{-mod} \rightarrow D^b(A)$ induces an equivalence from $A\text{-stab}$ to the quotient of $D^b(A)$ by the thick subcategory of perfect complexes of A -modules, making $A\text{-stab}$ into a triangulated category with translation functor Ω^{-1} .

Suppose that $\Lambda = \mathcal{O}$. We denote by $d : K_0(KA) \rightarrow K_0(kA)$ the decomposition map. It is characterized by the property $d([KM]) = [kM]$ for an A -lattice M .

Let G be a finite group and $A = KG$. We identify $\text{Irr}(A)$ with the set of K -valued irreducible characters of G . Given $\chi \in \text{Irr}(KG)$, we denote by b_χ the block idempotent of $\mathcal{O}G$ that is not in the kernel of χ . We put $e_G = \frac{1}{|G|} \sum_{g \in G} g$.

Let Q be an ℓ -subgroup of G . We denote by $\text{Br}_Q : \mathcal{O}G\text{-mod} \rightarrow kN_G(Q)\text{-mod}$ the Brauer functor: $\text{Br}_Q(M)$ is the image of M^Q in the coinvariants $(kM)_Q := k \otimes_{\mathcal{O}Q} M$. We denote by $\text{br}_Q : (\mathcal{O}G)^Q \rightarrow kC_G(Q)$ the algebra morphism that is the restriction of the linear map defined by $g \mapsto \delta_{g \in C_G(Q)} g$, where $\delta_{g \in H}$ equals 1 if $g \in H$ and 0 otherwise.

3. MODULAR REPRESENTATIONS AND GEOMETRY

3.1. Deligne–Lusztig varieties.

3.1.1. *Unipotent blocks.* Let \mathbf{G} be a connected reductive algebraic group defined over an algebraic closure of a finite field of characteristic p , together with an endomorphism F , a power of which is a Frobenius endomorphism. In other words, there exists a positive integer δ such that F^δ defines a split \mathbb{F}_{q^δ} -structure on \mathbf{G} for a certain power q^δ of p , where $q \in \mathbb{R}_{>0}$. We will assume that δ is minimal for this property. Given an F -stable closed subgroup \mathbf{H} of \mathbf{G} , we will denote by H the finite group of fixed points \mathbf{H}^F . The group G is a finite group of Lie type. We are interested in the modular representation theory of G in non-defining characteristic, so that we shall always work under the assumption $\ell \neq p$.

Let $\mathbf{T} \subset \mathbf{B}$ be a maximal torus contained in a Borel subgroup of \mathbf{G} , both of which are assumed to be F -stable. Let $W = N_{\mathbf{G}}(\mathbf{T})/\mathbf{T}$ be the Weyl group of \mathbf{G} and S be the set of simple reflections of W associated to \mathbf{B} . We denote by $r = r_G$ the F -semisimple rank of (\mathbf{G}, F) , i.e., the number of F -orbits on S .

Given $w \in W$, the *Deligne–Lusztig variety* associated to w is

$$X_{\mathbf{G}}(w) = X(w) = \{g\mathbf{B} \in \mathbf{G}/\mathbf{B} \mid g^{-1}F(g) \in \mathbf{B}w\mathbf{B}\}.$$

It is a smooth quasi-projective variety endowed with a left action of G by left multiplication.

Let Λ be either K or k . Recall that a simple ΛG -module is *unipotent* if it is a composition factor of $H_c^i(X(w), \Lambda)$ for some $w \in W$ and $i \geq 0$. We denote by $\text{Uch}(G) \subset \text{Irr}(KG)$ the set of unipotent irreducible KG -modules (up to isomorphism).

A *unipotent block* of $\mathcal{O}G$ is a block containing at least one unipotent character.

Given \mathbf{P} a parabolic subgroup of \mathbf{G} with unipotent radical \mathbf{U} and an F -stable Levi complement \mathbf{L} , we have a *Deligne–Lusztig variety*

$$Y_{\mathbf{G}}(\mathbf{L} \subset \mathbf{P}) = \{g\mathbf{U} \in \mathbf{G}/\mathbf{U} \mid g^{-1}F(g) \in \mathbf{U} \cdot F(\mathbf{U})\},$$

a variety with a left action of G and a free right action of L by multiplication. The *Deligne–Lusztig induction* is defined by

$$R_{\mathbf{L}\mathbf{C}\mathbf{P}}^{\mathbf{G}} : \mathbb{Z}\text{Irr}(KL) \rightarrow \mathbb{Z}\text{Irr}(KG), [M] \mapsto \sum_{i \geq 0} (-1)^i [H_c^i(Y_{\mathbf{G}}(\mathbf{L} \subset \mathbf{P})) \otimes_{KL} M].$$

We also write $R_L^G = R_{\mathbf{L}\mathbf{C}\mathbf{P}}^{\mathbf{G}}$. We denote by ${}^*R_{\mathbf{L}\mathbf{C}\mathbf{P}}^{\mathbf{G}} : \mathbb{Z}\text{Irr}(KG) \rightarrow \mathbb{Z}\text{Irr}(KL)$ the adjoint map. We have $R_{\mathbf{L}\mathbf{C}\mathbf{P}}^{\mathbf{G}}(\text{Uch}(L)) \subset \mathbb{Z}\text{Uch}(G)$ and ${}^*R_{\mathbf{L}\mathbf{C}\mathbf{P}}^{\mathbf{G}}(\text{Uch}(G)) \subset \mathbb{Z}\text{Uch}(L)$.

Let $w \in W$ and let $h \in \mathbf{G}$ such that $h^{-1}F(h)\mathbf{T} = w$. The maximal torus $\mathbf{L} = h\mathbf{T}h^{-1}$ is F -stable. It is contained in the Borel subgroup $\mathbf{P} = h\mathbf{B}h^{-1}$ with

unipotent radical \mathbf{U} . In that case, the map $g\mathbf{U} \mapsto g\mathbf{U}h = gh(h^{-1}\mathbf{U}h)$ identifies $Y(\mathbf{L} \subset \mathbf{P})$ with the variety

$$Y_{\mathbf{G}}(w) = Y(w) = \{g\mathbf{V} \in \mathbf{G}/\mathbf{V} \mid g^{-1}F(g) \in \mathbf{V}\dot{w}\mathbf{V}\}$$

where $\mathbf{V} = h^{-1}\mathbf{U}h$ is the unipotent radical of \mathbf{B} and $\dot{w} = h^{-1}F(h) \in N_{\mathbf{G}}(\mathbf{T})$. Furthermore, there is a morphism of varieties

$$Y(w) \rightarrow X(w), \quad g\mathbf{V} \mapsto g\mathbf{B}$$

corresponding to the quotient by $\mathbf{T}^{wF} \simeq L$.

3.1.2. Harish-Chandra induction and restriction. Given an F -stable subset I of S , we denote by W_I the subgroup of W generated by I and by \mathbf{P}_I and \mathbf{L}_I the standard parabolic subgroup and standard Levi subgroup respectively of \mathbf{G} corresponding to I . In that case, the maps $R_{\mathbf{L}_I}^{\mathbf{G}}$ and $*R_{\mathbf{L}_I}^{\mathbf{G}}$ are induced by the usual Harish-Chandra induction and restriction functors. A ΛG -module V is *cuspidal* if $*R_{\mathbf{L}_I}^{\mathbf{G}}(V) = 0$ for all proper F -stable subsets I of S .

The following result is due to Lusztig when \mathbf{L} is a torus [54, Corollary 2.19]. The same proof applies, using Mackey's formula for the Deligne–Lusztig restriction to a torus.

Proposition 3.1. *Let \mathbf{L} be an F -stable Levi subgroup of \mathbf{G} and ψ an irreducible character of L such that $(-1)^{r_G+r_L}R_{\mathbf{L}}^{\mathbf{G}}(\psi)$ is an irreducible character of G .*

If ψ is cuspidal and \mathbf{L} is not contained in a proper F -stable parabolic subgroup of \mathbf{G} , then $(-1)^{r_G+r_L}R_{\mathbf{L}}^{\mathbf{G}}(\psi)$ is cuspidal.

Proof. Let \mathbf{T} be an F -stable maximal torus contained in a proper F -stable parabolic subgroup \mathbf{P} of \mathbf{G} . The Mackey formula (see [22, 7.1]) provides a decomposition

$$*R_{\mathbf{T}}^{\mathbf{G}}R_{\mathbf{L}}^{\mathbf{G}}(\psi) = \frac{1}{|L|} \sum_{\substack{x \in G \\ \mathbf{T} \subset {}^x\mathbf{L}}} *R_{\mathbf{T}}^{x\mathbf{L}}(x\psi)$$

where $x\psi := \psi \circ \text{ad}x^{-1}$. Let $x \in G$ with $\mathbf{T} \subset {}^x\mathbf{L}$. By assumption, ${}^x\mathbf{L} \not\subset \mathbf{P}$, hence \mathbf{T} lies in the proper F -stable parabolic subgroup ${}^x\mathbf{L} \cap \mathbf{P}$ of ${}^x\mathbf{L}$. Since ψ is cuspidal, ψ^x is a cuspidal character of ${}^x\mathbf{L}$, hence $*R_{\mathbf{T}}^{x\mathbf{L}}(x\psi) = 0$ by [54, Proposition 2.18]. It follows that $*R_{\mathbf{T}}^{\mathbf{G}}((-1)^{r_G+r_L}R_{\mathbf{L}}^{\mathbf{G}}(\psi)) = 0$, hence $(-1)^{r_G+r_L}R_{\mathbf{L}}^{\mathbf{G}}(\psi)$ is cuspidal by [54, Proposition 2.18]. \square

Let $A = \mathcal{O}Gb$ be a block of $\mathcal{O}G$. Let \mathbf{P} be an F -stable parabolic subgroup of \mathbf{G} with unipotent radical \mathbf{U} and an F -stable Levi complement \mathbf{L} . Let $A' = \mathcal{O}Lb'$ be a block of $\mathcal{O}L$. We say that A is *relatively Harish-Chandra A' -projective* if the multiplication map $b\mathcal{O}Ge_Ub' \otimes_{\mathcal{O}Le_Ub'} \mathcal{O}Gb \rightarrow \mathcal{O}Gb$ is a split surjection as a morphism of (A, A) -bimodules. This implies in particular that any projective A -module is a direct summand of the Harish-Chandra induction of a projective A' -module.

The first part of the following lemma follows from [24, Proposition 1.11] (see [1, Proposition 3.4.(b)] for the general case of a p' -solvable group), while the second part is immediate.

Lemma 3.2. *Let \mathbf{P} be an F -stable parabolic subgroup of \mathbf{G} with unipotent radical \mathbf{U} and an F -stable Levi complement \mathbf{L} . Let Q be an ℓ -subgroup of L .*

Then $\mathbf{P} \cap C_{\mathbf{G}}(Q)^\circ$ is a parabolic subgroup of $C_{\mathbf{G}}(Q)^\circ$ with unipotent radical $\mathbf{V} = \mathbf{U} \cap C_{\mathbf{G}}(Q)$ and Levi complement $\mathbf{L} \cap C_{\mathbf{G}}(Q)^\circ$.

Given b and b' , block idempotents of $\mathcal{O}G$ and $\mathcal{O}L$ respectively, we have an isomorphism of $(kC_G(Q), kC_L(Q))$ -bimodules $\mathrm{Br}_{\Delta_Q}(b\mathcal{O}Ge_U b') \simeq \mathrm{br}_Q(b)kC_G(Q)e_V \mathrm{br}_Q(b')$.

Let D be a defect group of A and let $\mathbf{H} = C_{\mathbf{G}}^\circ(D)$. Assume that $H = C_G(D)$. Let λ be a character of H that is trivial on $Z(D)$ and such that $\mathrm{br}_D(b)b_\lambda = b_\lambda$.

The following lemma is a variation on [53, Proposition 4.2].

Lemma 3.3. *Let \mathbf{P} be an F -stable parabolic subgroup of \mathbf{G} with unipotent radical \mathbf{U} and an F -stable Levi complement \mathbf{L} .*

*Assume that $D \leq L$ and let λ' be a character of $C_L(D)$ such that $\langle {}^*R_{H \cap L}^H(\lambda), \lambda' \rangle \neq 0$ and such that λ' is the lift to $C_L(D)$ of a defect zero character of $C_L(D)/Z(D)$. Let $A' = \mathcal{O}b'$ be the block of $\mathcal{O}L$ of defect group D such that $\mathrm{br}_D(b')b_{\lambda'} = b_{\lambda'}$.*

Then the block A is relatively Harish-Chandra A' -projective.

Proof. Let \mathbf{V} be the unipotent radical of $\mathbf{H} \cap \mathbf{P}$ and let $\mathbf{M} = \mathbf{H} \cap \mathbf{L}$, a Levi complement of \mathbf{V} in $\mathbf{H} \cap \mathbf{P}$. Note that $D \subset M = C_L(D)$.

Recall that $H = C_G(D)$. The condition $\langle {}^*R_{H \cap L}^H(\lambda), \lambda' \rangle \neq 0$ implies that the multiplication map

$$b_\lambda k(H/Z(D))e_V b_{\lambda'} \otimes_{kM/Z(D)} e_V b_{\lambda'} k(H/Z(D))b_\lambda \rightarrow k(H/Z(D))b_\lambda$$

is surjective. It follows from Nakayama's Lemma that the multiplication map

$$b_\lambda kHb_{\lambda'} \otimes_{kM} kHb_{\lambda'} b_\lambda \rightarrow kHb_\lambda$$

is also surjective.

Since $\mathrm{br}_D(e_U) = e_V$, the commutativity of the diagram

$$\begin{array}{ccccc}
 kH \otimes_{kM} kH & \xrightarrow{\mathrm{can}} & (kG \otimes_{kL} kG)^{\Delta D} & \xrightarrow{\mathrm{mult}} & (kG)^{\Delta D} \\
 & & \downarrow \mathrm{can} & & \downarrow \mathrm{can} \\
 & & \mathrm{Br}_{\Delta D}(kG \otimes_{kL} kG) & \xrightarrow{\mathrm{Br}_{\Delta D}(\mathrm{mult})} & \mathrm{Br}_{\Delta D}(kG) \\
 & & & & \uparrow \sim \\
 & & & & kH \\
 & \searrow \mathrm{mult} & & & \nearrow \mathrm{can}
 \end{array}$$

together with Lemma 3.2 shows that the multiplication map induces a surjection

$$\mathrm{Br}_{\Delta D}(bkGe_U b' \otimes_{kL} b'e_U kGb) \twoheadrightarrow \mathrm{Br}_{\Delta D}(bkG).$$

We deduce from [1, Lemma A.1] that the multiplication map gives a split surjective morphism of $(\mathcal{O}Gb, \mathcal{O}Gb)$ -bimodules $b\mathcal{O}Ge_U b' \otimes_{\mathcal{O}L} b'e_U \mathcal{O}Gb \twoheadrightarrow b\mathcal{O}G$. \square

3.1.3. *Complex of cohomology and Frobenius action.* Following [30, Theorem 1.14], given a variety X defined over \mathbb{F}_{q^δ} with the action of a finite group H , there is a bounded complex $\tilde{\mathrm{R}}\Gamma_c(X, \mathcal{O})$ of $\mathcal{O}(H \times \langle F^\delta \rangle)$ -modules with the following properties:

- $\tilde{\mathrm{R}}\Gamma_c(X, \mathcal{O})$ is unique up to isomorphism in the quotient of the homotopy category of complexes of $\mathcal{O}(H \times \langle F^\delta \rangle)$ -modules by the thick subcategory of complexes whose restriction to $\mathcal{O}H$ is homotopic to 0;
- the terms of $\mathrm{Res}_{\mathcal{O}H} \tilde{\mathrm{R}}\Gamma_c(X, \mathcal{O})$ are direct summands of finite direct sums of modules of the form $\mathcal{O}(H/L)$, where L is the stabilizer in H of a point of X ;
- the image of $\tilde{\mathrm{R}}\Gamma_c(X, \mathcal{O})$ in the derived category of $\mathcal{O}(H \times \langle F^\delta \rangle)$ is the usual complex $\mathrm{R}\Gamma_c(X, \mathcal{O})$.

Note that in [30] such a complex was constructed over k instead of \mathcal{O} , but the same methods lead to a complex over \mathcal{O} . Indeed, note first that there is a bounded complex of $\mathcal{O}(H \times \langle F^\delta \rangle)$ -modules C constructed in [63, §2.5.2], whose restriction to $\mathcal{O}H$ has terms that are direct summands of possibly infinite direct sums of modules of the form $\mathcal{O}(H/L)$, where L is the stabilizer in L of a point of X . Furthermore, that restriction is homotopy equivalent to a bounded complex whose terms are direct summands of finite direct sums of modules of the form $\mathcal{O}(H/L)$, where L is the stabilizer in H of a point of X . One can then proceed as in [30] to construct $\tilde{\mathrm{R}}\Gamma_c(X, \mathcal{O})$.

Given $\lambda \in k^\times$, we denote by $L(\lambda)$ the inverse image of λ in \mathcal{O} . Given an $\mathcal{O}\langle F^\delta \rangle$ -module M that is finitely generated as an \mathcal{O} -module, we denote by

$$M_{(\lambda)} = \{m \in M \mid \exists \lambda_1, \dots, \lambda_N \in L(\lambda) \text{ such that } (F^\delta - \lambda_1) \cdots (F^\delta - \lambda_N)(m) = 0\}$$

the ‘generalized λ -eigenspace mod ℓ ’ of F^δ .

The image of $\tilde{\mathrm{R}}\Gamma_c(X, k)_{(\lambda)}$ in $D^b(kH)$ will be denoted by $\mathrm{R}\Gamma_c(X, k)_{(\lambda)}$ and we will refer to it as the generalized λ -eigenspace of F^δ on the cohomology complex of X .

When $\ell \nmid |\mathbf{T}^{wF}|$, the stabilizers of points of $X(w)$ under the action of G are ℓ' -groups and the terms of the complex of $\mathcal{O}G$ -modules $\tilde{\mathrm{R}}\Gamma_c(X(w), \mathcal{O})$ are projective.

Lemma 3.4. *Given $\zeta \in k^\times$, we have*

$$\mathrm{R}\Gamma_c(X(w), k)_{(q^{-\delta}\zeta)} \simeq \mathrm{R}\Gamma_c(X(w), k)_{(\zeta)}[2] \quad \text{in } kG\text{-stab}.$$

Proof. Recall (§3.1.1) that there is a variety $Y(w)$ acted on by $G = \mathbf{G}^F$ on the left and acted on freely by \mathbf{T}^{wF} on the right such that $Y(w)/\mathbf{T}^{wF} \simeq X(w)$. Consider the automorphism φ of \mathbf{T}^{wF} given by the action of $F^{-\delta}$. We have a right action of $\mathbf{T}^{wF} \rtimes \langle \varphi \rangle$ on $Y(w)$ where φ acts as F^δ . We have $\mathrm{R}\Gamma_c(Y(w), k) \otimes_{k\mathbf{T}^{wF}}^{\mathbb{L}} k \simeq \mathrm{R}\Gamma_c(X(w), k)$.

Let t be a generator of the Sylow ℓ -subgroup D of \mathbf{T}^{wF} and let $I = (t-1) \cdot kD$. We have $\varphi(t-1) = q^{-\delta}(t-1) \pmod{I^2}$, hence there is an exact sequence of $k(D \rtimes \langle \varphi \rangle)$ -modules

$$0 \rightarrow \ker f \rightarrow kD \otimes k_{-q^\delta} \xrightarrow{f} kD \rightarrow k \rightarrow 0$$

where k_{-q^δ} is the one-dimensional module with trivial D -action and where φ acts by multiplication by $q^{-\delta}$. The kernel of f is the socle $k((1+t+\dots+t^{|D|-1}) \otimes 1)$ of $kD \otimes k_{-q^\delta}$. Since φ acts on that line by multiplication by $q^{-\delta}$, the exact sequence above gives a φ -equivariant distinguished triangle $k \rightarrow k_{q^{-\delta}}[2] \rightarrow C \rightsquigarrow$ in $D^b(k\mathbf{T}^{wF})$, where C is perfect.

Applying $\mathrm{R}\Gamma_c(Y(w), k) \otimes_{k\mathbf{T}^{wF}}^{\mathbb{L}} -$, we obtain a distinguished triangle in $D^b(kG)$, equivariant for the action of F^δ

$$\mathrm{R}\Gamma_c(X(w), k) \rightarrow \mathrm{R}\Gamma_c(X(w), k) \otimes k_{q^{-\delta}}[2] \rightarrow C' \rightsquigarrow,$$

where C' is perfect. The lemma follows by taking generalized $q^{-\delta}\zeta$ -eigenspaces. \square

3.1.4. Simple modules in the cohomology of Deligne–Lusztig varieties. By definition, every simple unipotent kG -module occurs in the cohomology of some Deligne–Lusztig variety $X(w)$. If w is minimal for the Bruhat order, this module only occurs in middle degree. This will be an important property to compute the cohomology of $X(w)$ over \mathcal{O} from the cohomology over K . Let us now recall the precise result [3, Propositions 8.10 and 8.12]. We adapt the result to the varieties $X(w)$.

Recall that there is a pairing $K_0(kG\text{-proj}) \times K_0(kG\text{-mod}) \rightarrow \mathbb{Z}$ defined by

$$\langle [P]; [M] \rangle = \dim_k \mathrm{Hom}_{kG}(P, M)$$

for $P \in kG\text{-proj}$ and $M \in kG\text{-mod}$. The Cartan map $K_0(kG\text{-proj}) \rightarrow K_0(kG\text{-mod})$ is injective and we identify $K_0(kG\text{-proj})$ with its image. It is a submodule of finite index. In other words, for any $f \in K_0(kG\text{-proj})$, there is a positive integer N such that $Nf \in K_0(kG\text{-mod})$. Consequently the pairing above can be extended to a pairing $K_0(kG\text{-mod}) \times K_0(kG\text{-mod}) \rightarrow \mathbb{Q}$.

Proposition 3.5. *Let M be a simple unipotent kG -module and let $w \in W$. The following properties are equivalent:*

- (a) w is minimal such that $\mathrm{RHom}_{kG}^\bullet(\mathrm{R}\Gamma_c(X(w), k), M) \neq 0$;
- (b) w is minimal such that $\mathrm{RHom}_{kG}^\bullet(M, \mathrm{R}\Gamma_c(X(w), k)) \neq 0$;
- (c) w is minimal such that $\langle [\mathrm{R}\Gamma_c(X(w), k)], [M] \rangle \neq 0$.

Assume that w is such a minimal element. We have $\mathrm{Hom}_{kG}(M, \mathrm{H}_c^{\ell(w)}(X(w), k)) \neq 0$. If $\ell \nmid |\mathbf{T}^{wF}|$, then $\mathrm{Hom}_{D^b(kG)}(\mathrm{R}\Gamma_c(X(w), k), M[-i]) = \mathrm{Hom}_{D^b(kG)}(M, \mathrm{R}\Gamma_c(X(w), k)[i]) = 0$ for $i \neq \ell(w)$.

Proof. We use the variety $Y(w)$ as in the proof of Lemma 3.4. Since the stabilizers for the action of G on $Y(w)$ are p -groups (and hence ℓ' -groups), the complex $\mathrm{R}\Gamma_c(Y(w), k)$ is perfect (see §3.1.3) and therefore $[\mathrm{R}\Gamma_c(Y(w), k)] \in K_0(kG\text{-proj})$.

Let $\mathbf{T}_{\ell'}^{wF}$ be the subgroup of elements of \mathbf{T}^{wF} of order prime to ℓ and

$$b_w = \frac{1}{|\mathbf{T}_{\ell'}^{wF}|} \sum_{t \in \mathbf{T}_{\ell'}^{wF}} t$$

be the principal block idempotent of $k\mathbf{T}^{wF}$.

All composition factors of $b_w k\mathbf{T}^{wF}$ are trivial, hence $\mathrm{R}\Gamma_c(Y(w), k)b_w$ is an extension of $N = |\mathbf{T}^{wF}|_{\ell}$ copies of $\mathrm{R}\Gamma_c(X(w), k)$. As a consequence, $[\mathrm{R}\Gamma_c(Y(w), k)b_w] = N \cdot [\mathrm{R}\Gamma_c(X(w), k)]$.

We deduce that $\langle [\mathrm{R}\Gamma_c(X(w), k)], [M] \rangle \neq 0$ if and only if $\langle [\mathrm{R}\Gamma_c(Y(w), k)b_w], [M] \rangle \neq 0$. It follows also that an integer r is minimal such that $\mathrm{Hom}_{D^b(kG)}(M, \mathrm{R}\Gamma_c(X(w), k)[r]) \neq 0$ if and only if it is minimal such that $\mathrm{Hom}_{D^b(kG)}(M, \mathrm{R}\Gamma_c(Y(w), k)b_w[r]) \neq 0$. It follows that w is minimal such that $\mathrm{RHom}_{kG}^{\bullet}(M, \mathrm{R}\Gamma_c(Y(w), k)b_w) \neq 0$ if and only if (b) holds. Similarly, w is minimal such that $\mathrm{RHom}_{kG}^{\bullet}(\mathrm{R}\Gamma_c(Y(w), k)b_w, M) \neq 0$ if and only if (a) holds.

Note also that the statements above with $\mathrm{R}\Gamma_c(Y(w), k)b_w$ are equivalent to the same statements with $\mathrm{R}\Gamma_c(Y(w), k)$ since M is unipotent. The equivalence between (a), (b) and (c) follows now from [3, Proposition 8.12].

Suppose that w is minimal with the equivalent properties (a), (b) and (c). It follows from [3, Proposition 8.10] that the cohomology of $\mathrm{RHom}_{kG}^{\bullet}(M, \mathrm{R}\Gamma_c(Y(w), k)b_w)$ is concentrated in degree $\ell(w)$. The last assertions of the lemma follow. \square

Proposition 3.5 shows that for a minimal w , if $\ell \nmid |\mathbf{T}^{wF}|$, then the complex of kG -modules $\widetilde{\mathrm{R}}\Gamma_c(X(w), k)^{\mathrm{red}}$ is isomorphic to a bounded complex of projective modules such that a projective cover P_M of M appears only in degree $\ell(w)$ as a direct summand of a term of this complex.

3.2. Compactifications. Let \underline{S} be a set together with a bijection $S \xrightarrow{\sim} \underline{S}$, $s \mapsto \underline{s}$. Given $\underline{s} \in \underline{S}$, we put $\mathbf{B}_{\underline{s}}\mathbf{B} = \mathbf{B}s\mathbf{B} \cup \mathbf{B}$. The *generalized Deligne–Lusztig variety* associated to a sequence (t_1, \dots, t_d) of elements of $S \cup \underline{S}$ is

$$X(t_1, \dots, t_d) = \left\{ (g_0\mathbf{B}, \dots, g_d\mathbf{B}) \in (\mathbf{G}/\mathbf{B})^{d+1} \mid \begin{array}{l} g_i^{-1}g_{i+1} \in \mathbf{B}t_i\mathbf{B} \text{ for } i = 0, \dots, d-1 \\ g_d^{-1}F(g_0) \in \mathbf{B}t_d\mathbf{B} \end{array} \right\}.$$

If $w = s_1 \cdots s_d$ is a reduced expression of $w \in W$ then $X(s_1, \dots, s_d)$ is isomorphic to $X(w)$ and $X(\underline{s}_1, \dots, \underline{s}_d)$ is a smooth compactification of $X(w)$. It will be denoted by $\overline{X}(w)$ (even though it depends on the choice of a reduced expression of w).

Remark 3.6. Proposition 3.5 also holds for $X(w)$ replaced by $\overline{X}(w)$ (and the assertions for $X(w)$ are equivalent to the ones for $\overline{X}(w)$), with the assumption ‘ $\ell \nmid |\mathbf{T}^{wF}|$ ’ replaced by ‘ $\ell \nmid |\mathbf{T}^{vF}|$ for all $v \leq w$ ’ for the last statement. This follows from the fact that

$$\mathrm{RHom}_{kG}^{\bullet}(\mathrm{R}\Gamma_c(\overline{X}(w), k), M) \simeq \mathrm{RHom}_{kG}^{\bullet}(\mathrm{R}\Gamma_c(X(w), k), M)$$

whenever $\mathrm{RHom}_{kG}^{\bullet}(\mathrm{R}\Gamma_c(X(v), k), M) = 0$ for all $v < w$.

The cohomology of $\overline{X}(w)$ over K is known [25]. We provide here some partial information in the modular setting. Recall that two elements $w, w' \in W$ are F -conjugate if there exists $v \in W$ such that $w' = v^{-1}wF(v)$.

Proposition 3.7. *Let $w, w' \in W$. If $\ell \nmid |\mathbf{T}^{vF}|$ for all $v \leq w$ or for all $v \leq w'$, then $\mathrm{H}_c^*(\overline{X}(w) \times_G \overline{X}(w'), \mathcal{O})$ is torsion-free.*

Proof. Given $w, w' \in W$, Lusztig defined in [56] a decomposition of $\overline{X}(w) \times \overline{X}(w')$ as a disjoint union of locally closed subvarieties $Z_{\mathbf{a}}$ stable under the diagonal action of G . The quotient by G of each of these varieties has the same cohomology as an affine space. More precisely, given \mathbf{a} , there exists:

- a finite group \mathcal{T} , isomorphic to \mathbf{T}^{vF} for some $v \leq w$ and to $\mathbf{T}^{v'F}$ for some $v' \leq w'$ (F -conjugate to v), and a quasi-projective variety Z_0 acted on by $G \times \mathcal{T}$, where \mathcal{T} acts freely, together with a G -equivariant isomorphism $Z_0/\mathcal{T} \xrightarrow{\sim} Z_{\mathbf{a}}$;
- a quasi-projective variety Z_1 acted on freely by G and \mathcal{T} , such that $\mathrm{R}\Gamma_c(G \backslash Z_1, \mathcal{O})[2 \dim Z_1] \simeq \mathcal{O}$;
- a $(G \times \mathcal{T})$ -equivariant quasi-isomorphism

$$\mathrm{R}\Gamma_c(Z_0, \mathcal{O})[2 \dim Z_{\mathbf{a}}] \xrightarrow{\sim} \mathrm{R}\Gamma_c(Z_1, \mathcal{O})[2 \dim Z_1].$$

From these properties and [3, Lemma 3.2] we deduce that if \mathcal{T} is an ℓ' -group then

$$\begin{aligned} \mathrm{R}\Gamma_c(G \backslash Z_{\mathbf{a}}, \mathcal{O}) &\simeq \mathrm{R}\Gamma_c(G \backslash Z_0, \mathcal{O}) \otimes_{\mathcal{O}\mathcal{T}} \mathcal{O} \\ &\simeq \mathrm{R}\Gamma_c(G \backslash Z_1, \mathcal{O}) \otimes_{\mathcal{O}\mathcal{T}} \mathcal{O}[2 \dim Z_1 - 2 \dim Z_{\mathbf{a}}] \\ &\simeq \mathcal{O}[-2 \dim Z_{\mathbf{a}}]. \end{aligned}$$

As a consequence, the cohomology groups of $\overline{X}(w) \times_G \overline{X}(w')$ are the direct sums of the cohomology groups of the varieties $G \backslash Z_{\mathbf{a}}$ and the proposition follows. \square

Proposition 3.8. *Let I be an F -stable subset of S such that $\ell \nmid |L_I|$. If M is a simple kG -module such that ${}^*R_{L_I}^G(M) \neq 0$, then M is not a composition factor in the torsion of $\mathrm{H}_c^*(\overline{X}(w), \mathcal{O})$ for any $w \in W$.*

Proof. Let V be a simple kL_I -module such that $\mathrm{Hom}_{kL_I}(V, {}^*R_{L_I}^G(M)) \neq 0$. Let $v \in W_I$ be minimal such that V^* occurs as a composition factor, or equivalently as a direct summand, of $\mathrm{H}_c^*(X_{L_I}(v), k)$. By Remark 3.6, it follows that V^* occurs only in $\mathrm{H}_c^{\ell(v)}(\overline{X}_{L_I}(v), k)$. Since $\mathcal{O}_{L_I}\text{-mod}$ is a hereditary category, it follows that there is a projective \mathcal{O}_{L_I} -module V' such that $V' \otimes_{\mathcal{O}} k \simeq V^*$ and V' is a direct summand of $\mathrm{R}\Gamma_c(\overline{X}_{L_I}(v), \mathcal{O})$.

Since a projective cover P_{M^*} of M^* occurs as a direct summand of $R_{L_I}^G(V^*)$, we deduce that it occurs as a direct summand of $R_{L_I}^G(\mathrm{R}\Gamma_c(\overline{X}_{L_I}(v), \mathcal{O})) \simeq \mathrm{R}\Gamma_c(\overline{X}(v), \mathcal{O})$. It follows from the Künneth formula that the complex $P_M^* \otimes_{\mathcal{O}G} \mathrm{R}\Gamma_c(\overline{X}(w), \mathcal{O})$ is

a direct summand of the complex $\mathrm{R}\Gamma_c(\overline{X}(v) \times_G \overline{X}(w), \mathcal{O})$. By Proposition 3.7 applied to $\overline{X}(v) \times_G \overline{X}(w)$, we deduce that the cohomology of $P_M^* \otimes_{\mathcal{O}G} \mathrm{R}\Gamma_c(\overline{X}(w), \mathcal{O})$ is torsion-free, and hence M does not appear as a composition factor of the torsion of $\mathrm{H}_c^*(\overline{X}(w), \mathcal{O})$. \square

Remark 3.9. Note two particular cases of the previous proposition:

- if G is an ℓ' -group (i.e. if $\ell \nmid |G|$) then so is every subgroup, therefore $\mathrm{H}_c^*(\overline{X}(w), \mathcal{O})$ is torsion-free;
- if $\ell \nmid |L_I|$ for all F -stable $I \subsetneq S$, then the torsion in $\mathrm{H}_c^*(\overline{X}(w), \mathcal{O})$ is cuspidal.

Lemma 3.10. *Let Λ be one of k , \mathcal{O} and K . Let J be a subset of W such that if $w \in J$ and $w' < w$, then $w' \in J$ and such that given $w \in W$ and $s \in S$ with $l(sw) > l(w)$ and $l(wF(s)) > l(w)$, then $sw \in J$ if and only if $wF(s) \in J$.*

Let \mathcal{Z} be a thick subcategory of $D^b(\Lambda G)$ such that $\mathrm{R}\Gamma_c(X(v), \Lambda) \in \mathcal{Z}$ for all elements $v \in J$ that are of minimal length in their F -conjugacy class.

We have $\mathrm{R}\Gamma_c(X(v), \Lambda) \in \mathcal{Z}$ for all $v \in J$ and $\mathrm{R}\Gamma_c(\overline{X}(w), \Lambda) \in \mathcal{Z}$ for all $w \in J$.

Proof. Consider $s \in S$ and $v, v' \in W$ with $v = sv'F(s)$ and $v \neq v'$.

Assume that $\ell(v) = \ell(v')$, and furthermore that $\ell(sv) < \ell(v)$. We have $v = sv''$ where $\ell(v) = \ell(v'') + 1$ and $v' = v''F(s)$. The G -varieties $X(v)$ and $X(v')$ have the same étale site, hence isomorphic complexes of cohomology [22, Theorem 1.6]. If $\ell(sv) > \ell(v)$, then $\ell(vF(s)) < \ell(v)$ [51, Lemma 7.2] and $v = v''F(s)$ with $\ell(v) = \ell(v'') + 1$ and $v' = sv''$. We conclude as above.

Assume now that $\ell(v) = \ell(v') + 2$. It follows from [25, Proposition 3.2.10] that there is a distinguished triangle

$$\mathrm{R}\Gamma_c(X(sv'), \Lambda)[-2] \oplus \mathrm{R}\Gamma_c(X(sv'), \Lambda)[-1] \rightarrow \mathrm{R}\Gamma_c(X(v), \Lambda) \rightarrow \mathrm{R}\Gamma_c(X(v'), \Lambda)[-2] \rightsquigarrow .$$

So, if $\mathrm{R}\Gamma_c(X(v'), \Lambda) \in \mathcal{Z}$ and $\mathrm{R}\Gamma_c(X(sv'), \Lambda) \in \mathcal{Z}$, then $\mathrm{R}\Gamma_c(X(v), \Lambda) \in \mathcal{Z}$.

By [43, 45], any element $v \in W$ can be reduced to an element of minimal length in its F -conjugacy class by applying one of the transformations $v \rightarrow v'$ above. Note that if $v \in J$, then $v' \in J$. The lemma follows from the discussion above. \square

3.3. Steinberg representation. We denote by \mathbf{U} the unipotent radical of the Borel subgroup \mathbf{B} . Let ψ be a regular character of U (see [4, §2.1]), e_ψ be the corresponding central idempotent in $\mathcal{O}U$ and $\Gamma_\psi = \mathrm{Ind}_U^G(e_\psi \mathcal{O}U)$ be the Gelfand-Graev module attached to ψ . It is a projective $\mathcal{O}G$ -module. Since $K\Gamma_\psi$ has only one unipotent constituent (namely the Steinberg character, which we denote by St), the projection of Γ_ψ onto the sum of unipotent blocks is indecomposable and does not depend on ψ . Indeed, it is proved in the proof of [46, Theorem 3.2] that any projective module in a unipotent block has a unipotent constituent in its character (this does not use the connectedness of the center of \mathbf{G}). Consequently, Γ_ψ has a unique unipotent simple quotient St_ℓ . It is called the *modular Steinberg representation*. It is cuspidal if $\ell \nmid |L_I|$ for all F -stable $I \subsetneq S$ [42, Theorem 4.2].

Statement (i) of the proposition below is a result of [27].

Proposition 3.11. *Let t_1, \dots, t_d be elements of $S \cup \underline{S}$.*

- (i) *If $t_i \in S$ for all i , then $\mathrm{Hom}_{\mathcal{O}G}^{\bullet}(\Gamma_{\psi}, \mathrm{R}\Gamma_c(X(t_1, \dots, t_d), \mathcal{O})) \simeq \mathcal{O}[-\ell(w)]$ in $D^b(\mathcal{O})$, and hence St_{ℓ} does not occur as a composition factor of $\mathrm{H}_c^i(X(t_1, \dots, t_d), k)$ for $i \neq \ell(w)$.*
- (ii) *If $t_i \notin S$ for some i , then $\mathrm{Hom}_{\mathcal{O}G}^{\bullet}(\Gamma_{\psi}, \mathrm{R}\Gamma_c(X(t_1, \dots, t_d), \mathcal{O}))$ is acyclic, and hence St_{ℓ} does not occur as a composition factor of $\mathrm{H}_c^*(X(t_1, \dots, t_d), k)$.*
- (iii) *St_{ℓ} does not occur as a composition factor of the torsion part of $\mathrm{H}_c^*(X(t_1, \dots, t_d), \mathcal{O})$.*

Proof. (i) follows from [27] when $t_1 \cdots t_d$ is reduced, and the general case follows by changing \mathbf{G} and F as in [25, Proposition 2.3.3].

Assume now that $t_i \in \underline{S}$ for all i . Using the decomposition of $X(t_1, \dots, t_d)$ into Deligne–Lusztig varieties associated to sequences of elements of S , we deduce from the first part of the proposition that the cohomology of $\mathrm{Hom}_{kG}^{\bullet}(k\Gamma_{\psi}, \mathrm{R}\Gamma_c(X(t_1, \dots, t_d), k))$ is zero outside degrees $0, \dots, d$. Since $X(t_1, \dots, t_d)$ is a smooth projective variety and $(\Gamma_{\psi})^* = \Gamma_{\psi^*}$, we deduce that the cohomology is also zero outside the degrees $d, \dots, 2d$ and therefore it is concentrated in degree d . As a consequence, the cohomology of $\mathrm{Hom}_{\mathcal{O}G}^{\bullet}(\Gamma_{\psi}, \mathrm{R}\Gamma_c(X(t_1, \dots, t_d), \mathcal{O}))$ is free over \mathcal{O} and concentrated in degree d . By [25, Proposition 3.3.15], we have $\mathrm{Hom}_{KG}^{\bullet}(K\Gamma_{\psi}, \mathrm{R}\Gamma_c(X(t_1, \dots, t_d), K)) = 0$, and hence $\mathrm{Hom}_{\mathcal{O}G}^{\bullet}(\mathcal{O}\Gamma_{\psi}, \mathrm{R}\Gamma_c(X(t_1, \dots, t_d), \mathcal{O})) = 0$.

(ii) follows now by induction on the number of i such that t_i is in S : if one of the t_i is in S , say t_1 , we use the distinguished triangle

$$\mathrm{R}\Gamma_c(X(t_1, t_2, \dots, t_d), \mathcal{O}) \longrightarrow \mathrm{R}\Gamma_c(X(\underline{t_1}, t_2, \dots, t_d), \mathcal{O}) \longrightarrow \mathrm{R}\Gamma_c(X(t_2, \dots, t_d), \mathcal{O}) \rightsquigarrow$$

and use induction. Note that the assumption that one of the t_i is in \underline{S} ensures that we never reach $X(1) = G/B$.

Note finally that (iii) follows from (i) and (ii). □

Proposition 3.12. *If $\ell \nmid |L_I|$ for all F -stable $I \subsetneq S$, then $K \otimes_{\mathcal{O}} \Omega^r \mathcal{O} \simeq \mathrm{St}$.*

Proof. Given $i \in \{1, \dots, r\}$, let $M_i = \bigoplus_I R_{L_I}^G \circ^* R_{L_I}^G(\mathcal{O})$, where I runs over F -stable subsets of S such that $|I/F| = i$. By the Solomon–Tits Theorem [20, Theorem 66.33], there is an exact sequence of $\mathcal{O}G$ -modules

$$0 \rightarrow M \rightarrow M^0 \rightarrow \dots \rightarrow M^r \rightarrow 0,$$

where $KM \simeq \mathrm{St}$.

By assumption, M^i is projective for $i \neq r$, while $M^r = \mathcal{O}$. We deduce that $M \simeq \Omega^r \mathcal{O}$. □

3.4. Coxeter orbits. Let s_1, \dots, s_r be a set of representatives of F -orbits of simple reflections. The product $c = s_1 \cdots s_r$ is a *Coxeter element* of (W, F) . Throughout this section and §4.3.5, we will assume that $\ell \nmid |\mathbf{T}^{cF}|$, and hence $\widetilde{\mathrm{R}}\Gamma_c(X(c), \mathcal{O})$ is a bounded complex of finitely generated projective $\mathcal{O}G$ -modules.

If $v \in W$ satisfies $\ell(v) < \ell(c)$ then v lies in a proper F -stable parabolic subgroup, forcing $\mathrm{Hom}_{kG}^\bullet(\mathrm{R}\Gamma_c(\mathrm{X}(v), k), M)$ to be zero for every cuspidal module kG -module M . Therefore Proposition 3.5 has the following corollary for Coxeter elements.

Corollary 3.13. *Let c be a Coxeter element and M be a cuspidal kG -module. If $\ell \nmid |\mathbf{T}^{cF}|$, then the cohomology of $\mathrm{RHom}_{kG}^\bullet(\mathrm{R}\Gamma_c(\mathrm{X}(c), k), M)$ and of $\mathrm{RHom}_{kG}^\bullet(M, \mathrm{R}\Gamma_c(\mathrm{X}(c), k))$ vanishes outside degree r .*

Lemma 3.14. *Assume that $\ell \nmid |\mathbf{T}^{cF}|$. Let C be a direct summand of $\widetilde{\mathrm{R}}\Gamma_c(\mathrm{X}(c), \mathcal{O})$ in $\mathrm{Ho}^b(\mathcal{O}G\text{-mod})$ such that*

- (i) *the torsion part of $\mathrm{H}^*(C)$ is cuspidal, and*
- (ii) *$\mathrm{H}^i(kC) = 0$ for $i \neq r$.*

Then $\mathrm{H}^r(C)$ is a projective $\mathcal{O}G$ -module and $\mathrm{H}^i(C) = 0$ for $i \neq r$.

Proof. Since $r = \ell(c)$, the complex C can be chosen, up to isomorphism in $\mathrm{Ho}^b(\mathcal{O}G\text{-mod})$, to be a complex with projective terms in degrees $r, \dots, 2r$ and zero terms outside those degrees. Let i be maximal such that $\mathrm{H}^i(C) \neq 0$ (or equivalently such that $\mathrm{H}^i(kC) \neq 0$). There is a non-zero map $kC \rightarrow \mathrm{H}^i(kC)[-i]$ in $D^b(kG)$. From Corollary 3.13 and the assumption (i) we deduce that $i = r$. It follows that the cohomology of C is concentrated in degree r . Since C is a bounded complex of projective modules, it follows that $\mathrm{H}^r(C)$ is projective. \square

Proposition 3.15. *Let $I \subset S$ be an F -stable subset and let c_I be a Coxeter element of W_I .*

- (i) *If $\ell \nmid |L_I|$, then $\mathrm{H}_c^*(\mathrm{X}(c_I), \mathcal{O})$ is torsion-free.*
- (ii) *If $\mathrm{H}_c^*(\mathrm{X}(c_I), \mathcal{O})$ is torsion-free, then the torsion of $\mathrm{H}_c^*(\mathrm{X}(c), \mathcal{O})$ is killed by ${}^*R_{L_I}^G$.*

Proof. The first statement follows from [29, Corollary 3.3] using $\mathrm{H}_c^*(\mathrm{X}(c_I), \mathcal{O}) = R_{L_I}^G(\mathrm{H}_c^*(\mathrm{X}_{L_I}(c_I), \mathcal{O}))$.

The image by ${}^*R_{L_I}^G$ of the torsion of $\mathrm{H}_c^*(\mathrm{X}(c), \mathcal{O})$ is the torsion of $\mathrm{H}_c^*(U_I \setminus \mathrm{X}(c), \mathcal{O})$. By [55, Corollary 2.10], the variety $U_I \setminus \mathrm{X}(c)$ is isomorphic to $(\mathbb{G}_m)^{r-r_I} \times \mathrm{X}_{L_I}(c_I)$. The second statement follows. \square

3.5. Generic theory. We recall here constructions of [7, 8, 9], the representation theory part being based on Lusztig's theory.

3.5.1. Reflection data. Let $K = \mathbb{Q}(q)$ and $V = K \otimes_{\mathbb{Z}} Y$, where Y is the cocharacter group of \mathbf{T} . We denote by φ the finite order automorphism of V induced by the action of $q^{-1}F$.

We denote by $|(W, \varphi)| = x^N \prod_{i=1}^{\dim V} (x^{d_j} - \zeta_j)$ the *polynomial order* of (W, φ) . Here, N is the number of reflections of W and we have fixed a decomposition into a direct sum of $(\mathbf{G}_m \times \langle \varphi \rangle)$ -stable lines $L_1 \oplus \dots \oplus L_{\dim V}$ of the tangent space at 0 of V/W , so that d_j is the weight of the action of \mathbf{G}_m on L_j and ζ_j is the eigenvalue of φ on L_j .

Recall that there is some combinatorial data associated with W (viewed as a reflection group on V) and φ :

- a finite set $\text{Uch}(W, \varphi)$;
- a map $\text{Deg} : \text{Uch}(W, \varphi) \rightarrow \mathbb{Q}[x]$.

We endow $\mathbb{Z}\text{Uch}(W, \varphi)$ with a symmetric bilinear form making $\text{Uch}(W, \varphi)$ an orthonormal basis.

In addition, given W' a parabolic subgroup of W and $w \in W$ such that $\text{ad}(w)\varphi(W') = W'$, there is a linear map $R_{W', \text{ad}(w)\varphi}^{W, \varphi} : \mathbb{Z}\text{Uch}(W', \text{ad}(w)\varphi) \rightarrow \mathbb{Z}\text{Uch}(W, \varphi)$.

We will denote by ${}^*R_{W', \text{ad}(w)\varphi}^{W, \varphi}$ the adjoint map to $R_{W', \text{ad}(w)\varphi}^{W, \varphi}$.

The data associated with W and φ depends only on the class of φ in $\text{GL}(V)/W$. The corresponding pair $\mathbb{G} = (W, W\varphi)$ is called a *reflection datum*.

A pair $\mathbb{L} = (W', \text{ad}(w)\varphi)$ as above is called a *Levi subdatum* of (W, φ) . We put $W_{\mathbb{L}} = W'$.

There is a bijection

$$\text{Uch}(\mathbb{G}) \xrightarrow{\sim} \text{Uch}(G), \boldsymbol{\chi} \mapsto \boldsymbol{\chi}_q$$

such that $\text{Deg}(\boldsymbol{\chi})(q) = \boldsymbol{\chi}_q(1)$.

There is a bijection from the set of W -conjugacy classes of Levi subdata of \mathbb{G} to the set of G -conjugacy classes of F -stable Levi subgroups of \mathbf{G} .

Those bijections have the property that given \mathbf{L} an F -stable Levi subgroup of \mathbf{G} with associated Levi subdatum $\mathbb{L} = (W', \text{ad}(w)\varphi)$, we have $(R_{\mathbb{L}}^{\mathbf{G}}(\boldsymbol{\chi}))_q = R_L^{\mathbf{G}}(\boldsymbol{\chi}_q)$ for all $\boldsymbol{\chi} \in \text{Uch}(W, \varphi)$ (assuming $q > 2$ if (\mathbf{G}, F) has a component of type 2E_6 , E_7 or E_8 , in order for the Mackey formula to be known to hold [2]).

3.5.2. d -Harish-Chandra theory. Let Φ be a cyclotomic polynomial over K , i.e., a prime divisor of $X^n - 1$ in $K[X]$ for some $n \geq 1$. Let V' be a subspace of V and let $w \in W$ such that $w\varphi$ stabilizes V' and the characteristic polynomial of $w\varphi$ acting on V' is a power of Φ . Let $W' = C_W(V')$. Then $(W', \text{ad}(w)\varphi)$ is called a Φ -split Levi subdatum of (W, φ) .

An element $\boldsymbol{\chi} \in \text{Uch}(W, \varphi)$ is Φ -cuspidal if ${}^*R_{\mathbb{L}}^{\mathbf{G}}(\boldsymbol{\chi}) = 0$ for all proper Φ -split Levi subdata \mathbb{L} of \mathbb{G} (when \mathbf{G} is semisimple, this is equivalent to the requirement that $\text{Deg}(\boldsymbol{\chi})_{\Phi} = |\mathbf{G}|_{\Phi}$).

A pair $(\mathbb{L}, \boldsymbol{\lambda})$ is a Φ -cuspidal pair of \mathbb{G} if $\mathbb{L} = (W', \text{ad}(w)\varphi)$ is a Φ -split Levi subdata of \mathbb{G} and $\boldsymbol{\lambda} \in \text{Uch}(W', \text{ad}(w)\varphi)$ is Φ -cuspidal. Given such a pair $(\mathbb{L}, \boldsymbol{\lambda})$, we denote by $\text{Uch}(\mathbb{G}, (\mathbb{L}, \boldsymbol{\lambda}))$ the set of $\boldsymbol{\chi} \in \text{Uch}(\mathbb{G})$ such that $\langle R_{\mathbb{L}}^{\mathbf{G}}(\boldsymbol{\lambda}), \boldsymbol{\chi} \rangle \neq 0$. We denote by $W_{\mathbb{G}}(\mathbb{L}, \boldsymbol{\lambda}) = N_W(W_{\mathbb{L}})/W_{\mathbb{L}}$ the relative Weyl group.

The Φ -Harish-Chandra theory states that:

- $\text{Uch}(\mathbb{G})$ is the disjoint union of the sets $\text{Uch}(\mathbb{G}, (\mathbb{L}, \boldsymbol{\lambda}))$, where $(\mathbb{L}, \boldsymbol{\lambda})$ runs over W -conjugacy classes of Φ -cuspidal pairs;
- there is an isometry

$$I_{(\mathbb{L}, \boldsymbol{\lambda})}^{\mathbf{G}} : \mathbb{Z} \text{Irr}(W_{\mathbb{G}}(\mathbb{L}, \boldsymbol{\lambda})) \xrightarrow{\sim} \mathbb{Z}\text{Uch}(\mathbb{G}, (\mathbb{L}, \boldsymbol{\lambda}));$$

- those isometries have the property that $R_{\mathbb{M}}^{\mathbb{G}} I_{(\mathbb{L}, \boldsymbol{\lambda})}^{\mathbb{M}} = I_{(\mathbb{L}, \boldsymbol{\lambda})}^{\mathbb{G}} \text{Ind}_{W_{\mathbb{M}}(\mathbb{L}, \boldsymbol{\lambda})}^{W_{\mathbb{G}}(\mathbb{L}, \boldsymbol{\lambda})}$ for all Φ -split Levi subdata \mathbb{M} of \mathbb{G} containing \mathbb{L} .

The sets $\text{Uch}(\mathbb{G}, (\mathbb{L}, \boldsymbol{\lambda}))$ are called the Φ -blocks of \mathbb{G} . The *defect* of the Φ -block $\text{Uch}(\mathbb{G}, (\mathbb{L}, \boldsymbol{\lambda}))$ is the integer $i \geq 0$ such that the common value of $\text{Deg}(\boldsymbol{\chi})_{\Phi}$ for $\boldsymbol{\chi} \in \text{Uch}(\mathbb{G}, (\mathbb{L}, \boldsymbol{\lambda}))$ is Φ^i (see §4.2.3 for the relation with unipotent ℓ -blocks).

4. UNIPOTENT BLOCKS WITH CYCLIC DEFECT GROUPS

4.1. Blocks with cyclic defect groups. We recall some basic facts on blocks with cyclic defect groups (cf. [33] and [32] for the folding).

4.1.1. *Brauer trees and folding.*

Definition 4.1. A *Brauer tree* is a planar tree T with at least one edge together with a positive integer m (the ‘multiplicity’) and, if $m \geq 2$, the data of a vertex v_x , the ‘exceptional vertex’.

Note that the data of an isomorphism class of planar trees is the same as the data of a tree together with a cyclic ordering of the vertices containing a given vertex.

Let $d > 1$ be a divisor of m . We define a new Brauer tree $\wedge^d T$. It has a vertex \tilde{v}_x , and the oriented graph $(\wedge^d T) \setminus \{\tilde{v}_x\}$ is the disjoint union $(T \setminus \{v_x\}) \times \mathbb{Z}/d$ of d copies of $T \setminus \{v_x\}$. Let l_1, \dots, l_r be the edges of T containing v_x , in the cyclic ordering. The edges of the tree $\wedge^d T$ containing \tilde{v}_x are, in the cyclic ordering, $(l_1, 0), \dots, (l_1, d-1), (l_2, 0), \dots, (l_2, d-1), \dots, (l_r, 0), \dots, (l_r, d-1)$. Finally, for every $i \in \mathbb{Z}/d$, we have an embedding of oriented trees of T in $\wedge^d T$ given on edges by $l \mapsto (l, i)$, on non-exceptional vertices by $v \mapsto (v, i)$ and finally $v_x \mapsto \tilde{v}_x$. The multiplicity of $\wedge^d T$ is m/d . When $m \neq d$, the exceptional vertex of $\wedge^d T$ is \tilde{v}_x .

There is an automorphism σ of $\wedge^d T$ given by $\sigma(\tilde{v}_x) = \tilde{v}_x$ and $\sigma(v, i) = (v, i+1)$ for $v \in T \setminus \{v_x\}$. Let X be the group of automorphisms of $\wedge^d T$ generated by σ . There is an isomorphism of planar trees

$$\kappa : (\wedge^d T)/X \xrightarrow{\sim} T, \quad \tilde{v}_x \mapsto v_x, \quad X \cdot (v, i) \mapsto v \text{ for } v \in T \setminus \{v_x\}.$$

In particular the Brauer tree $T' = \wedge^d T$ together with the automorphism group X determine T .

Remark 4.2. Given another planar embedding T' of $\wedge^d T$ compatible with the automorphism σ above and such that κ induces an isomorphism of planar trees $T'/X \xrightarrow{\sim} T$, then there is an isomorphism of planar trees $T' \xrightarrow{\sim} \wedge^d T$ compatible with σ .

4.1.2. *Brauer tree of a block with cyclic defect.* Let H be a finite group and $A = b\mathcal{O}H$ be a block of $\mathcal{O}H$. Let D be a defect group of A and let b_D be a block idempotent of the Brauer correspondent of b in $\mathcal{O}N_H(D)$. We assume D is cyclic and non-trivial. Let $E = N_H(D, b_D)/C_H(D)$, a cyclic subgroup of $\text{Aut}(D)$ of order e dividing $\ell - 1$.

When $e = 1$, the block A is Morita equivalent to $\mathcal{O}D$. We will be discussing Brauer trees only when $e > 1$, an assumption we make for the remainder of §4.1.

We define a Brauer tree T associated to A . We put $m = (|D| - 1)/e$. An irreducible character χ of KA is called *non-exceptional* if $d(\chi) \neq d(\chi')$ for all $\chi' \in \text{Irr}(KA)$ for $\chi' \neq \chi$ (here d is the decomposition map). When $m > 1$, we denote by χ_x the sum of the exceptional irreducible characters of KA (those that are not non-exceptional). We define the set of vertices of T as the union of the non-exceptional characters together, when $m > 1$, with an exceptional vertex corresponding to χ_x . The set of edges is defined to be $\text{Irr}(kA)$. An edge ϕ has vertices χ and χ' if $\chi + \chi'$ is the character of the projective cover of the simple A -module with Brauer character ϕ . Note that the tree T has e edges.

The cyclic ordering of the edges containing a given vertex is defined as follows: the edge ϕ_2 comes immediately after the edge ϕ_1 if $\text{Ext}_A^1(L_1, L_2) \neq 0$, where L_i is the simple A -module with Brauer character ϕ_i .

Recall that the full subgraph of T with vertices the real-valued non-exceptional irreducible characters and the exceptional vertex if $m > 1$ is a line (the ‘real stem’ of the tree). There is an embedding of the tree T in \mathbb{C} where the intersection of T with the real line is the real stem and taking duals of irreducible characters corresponds to reflection with respect to the real line.

4.1.3. Folding. Let H' be a finite group containing H as a normal subgroup and let b' be a block idempotent of $\mathcal{O}H'$ such that $bb' \neq 0$. We put $A' = b'\mathcal{O}H'$ and we denote by T' the Brauer tree of A' , with multiplicity m' . We assume D is a defect group of b' . Let b'_D be the block idempotent of $\mathcal{O}N_{H'}(D)$ that is the Brauer correspondent of b' and let $E' = N_{H'}(D, b'_D)/C_{H'}(D)$, an ℓ' -subgroup of $\text{Aut}(D)$. Note that E is a subgroup of E' . Let H'_b be the stabilizer of b in H' . We have $H'_b = HN_{H'}(D, b'_D)$ and there is a Morita equivalence between $b\mathcal{O}H'_b$ and $b'\mathcal{O}H'$ induced by the bimodule $b\mathcal{O}H'_b$.

Suppose that $E' \neq E$, i.e., $m' \neq m$, since $[E' : E] = m/m'$. The group X of 1-dimensional characters of $E'/E \simeq H'_b/H$ acts on $\text{Irr}(KA')$ and on $\text{Irr}(kA')$ and this induces an action on T' , the Brauer tree associated to A' .

The result below is a consequence of [32, proof of Lemma 4.3] (the planar embedding part follows from Remark 4.2).

Proposition 4.3. *There is an isomorphism of Brauer trees $\wedge^d T \xrightarrow{\sim} T'$ such that (χ, i) maps to a lift of χ , for χ a non-exceptional vertex.*

The previous proposition shows that the data of T' and of the action of X on T determine the tree T (up to parametrization).

4.2. Structure of unipotent blocks with cyclic defect groups. We assume in §4.2 that the simple factors of $[\mathbf{G}, \mathbf{G}]$ are F -stable. Note that every finite reductive group can be realized as \mathbf{G}^F for such a \mathbf{G} .

From now on, we assume that ℓ is an odd prime.

4.2.1. *Centre.* We show here that a Brauer tree of a unipotent block of a finite reductive group (in non-describing characteristic) is isomorphic to one coming from a simple simply connected algebraic group.

Lemma 4.4. *Assume that \mathbf{G} is simple and simply connected. Let A be a unipotent block of $k\mathbf{G}^F$ whose image in $k(\mathbf{G}^F/(Z(\mathbf{G})^F)_\ell)$ has cyclic defect. Then, A has cyclic defect and $Z(\mathbf{G})^F_\ell = 1$.*

Proof. Since ℓ is odd, it divides $|Z(\mathbf{G})^F|$ only in the following cases [60, Corollary 24.13]:

- $(\mathbf{G}, F) = \mathrm{SL}_n(q)$, $n \geq 2$ and $\ell \mid (n, q - 1)$;
- $(\mathbf{G}, F) = \mathrm{SU}_n(q)$, $n \geq 3$ and $\ell \mid (n, q + 1)$;
- $(\mathbf{G}, F) = E_6(q)$ and $\ell \mid (3, q - 1)$;
- $(\mathbf{G}, F) = {}^2E_6(q)$ and $\ell \mid (3, q + 1)$.

Let $H = \mathbf{G}^F/(Z(\mathbf{G})^F)_\ell$. Suppose that the image of A in kH has non-trivial defect groups.

Assume that $(\mathbf{G}, F) = \mathrm{SL}_n(q)$, $n \geq 2$ and $\ell \mid (n, q - 1)$ or $(\mathbf{G}, F) = \mathrm{SU}_n(q)$, $n \geq 3$ and $\ell \mid (n, q + 1)$. In those cases, the only unipotent block A is the principal block [14, Theorem 13], so H has cyclic Sylow ℓ -subgroups: this is impossible.

Assume that $(\mathbf{G}, F) = E_6(q)$ and $\ell \mid (3, q - 1)$. Note that A cannot be the principal block, as H does not have cyclic Sylow 3-subgroups. There is a unique non-principal unipotent block b , and its unipotent characters are the ones in the Harish-Chandra series with Levi subgroup \mathbf{L} of type D_4 [31, ‘‘Données cuspidales 7,8,9’’, p.352–353]. Those three unipotent characters are trivial on $Z(\mathbf{G})^F$. It is easily seen that there is no equality between their degrees nor is the sum of two degrees equal the third one. As a consequence, they cannot belong to a block of kH with cyclic defect and inertial index at most 2.

The same method (replacing q by $-q$) shows also that b cannot have cyclic defect when $(\mathbf{G}, F) = {}^2E_6(q)$ and $\ell \mid (3, q + 1)$. \square

Let H be a finite simple group of Lie type. Then there is a simple simply connected reductive algebraic group \mathbf{G} endowed with an isogeny F such that $H \simeq \mathbf{G}^F/Z(\mathbf{G})^F$, unless H is the Tits group, $(\mathbf{G}, F) = {}^2F_4(2)$ and we have $H = [\mathbf{G}^F/Z(\mathbf{G})^F, \mathbf{G}^F/Z(\mathbf{G})^F]$, a subgroup of index 2 of $\mathbf{G}^F/Z(\mathbf{G})^F$.

The previous lemma shows that if the image in kH of a unipotent ℓ -block of $k\mathbf{G}^F$ has cyclic defect groups, then the block of $k\mathbf{G}^F$ already has cyclic defect groups. By folding (§4.1.3), the Brauer tree of a unipotent block of $\mathcal{O}\mathbf{G}^F$ determines the Brauer tree of the corresponding block of $\mathcal{O}H$.

Proposition 4.5. *Let A be a unipotent block of $\mathcal{O}\mathbf{G}^F$ with cyclic defect group D . We have $C_{\mathbf{G}}^\circ(x) = C_{\mathbf{G}}^\circ(D)$ and $C_G(x) = C_{\mathbf{G}}^\circ(x)^F$ for all non trivial elements $x \in D$. Furthermore, one of the two following statements hold:*

- D is the Sylow ℓ -subgroup of $Z^\circ(\mathbf{G})^F$ and there is a finite subgroup H of G containing $[\mathbf{G}, \mathbf{G}]^F$ such that $G = D \times H$;

- $|Z(\mathbf{G})^F|_\ell = 1$, $D \neq 1$ and A is Morita equivalent to a unipotent block of a simple factor of $\mathbf{G}/Z(\mathbf{G})$ with cyclic defect groups isomorphic to D .

In particular, $Z(\mathbf{G})^F/Z^\circ(\mathbf{G})^F$ is an ℓ' -group.

Proof. Let \mathbf{H} be a simple factor of $[\mathbf{G}, \mathbf{G}]$. Consider a simply connected cover \mathbf{H}_{sc} of \mathbf{H} . The restriction of unipotent characters in A to H and then to \mathbf{H}_{sc}^F are sums of unipotent characters, and the blocks that contain them have a defect group that is cyclic modulo $Z(\mathbf{H}_{\text{sc}})^F$. It follows from Lemma 4.4 that $\ell \nmid Z(\mathbf{H}_{\text{sc}})^F$, and therefore $\ell \nmid Z(\mathbf{G}_{\text{sc}})^F$, where \mathbf{G}_{sc} is a simply connected cover of $[\mathbf{G}, \mathbf{G}]$. Note that as a consequence, both $(Z(\mathbf{G})/Z^\circ(\mathbf{G}))^F$ and $(Z(\mathbf{G}^*)/Z^\circ(\mathbf{G}^*))^F$ are ℓ' -groups, where \mathbf{G}^* is a Langlands dual of \mathbf{G} .

Let $\mathbf{G}_{\text{ad}} = \mathbf{G}/Z(\mathbf{G})$. By [16, Theorem 17.7], we have $A \simeq \mathcal{O}Z(\mathbf{G})_\ell^F \otimes A'$, where A' is the unipotent block of G_{ad} containing the unipotent characters of A . Also, $D \simeq Z(\mathbf{G})_\ell^F \times D'$, where D' is a defect group of A' . So, if ℓ divides $|Z(\mathbf{G})^F|$, then ℓ divides $|Z^\circ(\mathbf{G})^F|$, $D' = 1$ and D is the Sylow ℓ -subgroup of $Z(\mathbf{G})^F$. Otherwise, consider a decomposition $\mathbf{G}_{\text{ad}} = \mathbf{G}_1 \times \cdots \times \mathbf{G}_r$ where the \mathbf{G}_i are simple and F -stable factors. There is a corresponding decomposition $A' = A_1 \otimes \cdots \otimes A_r$ where A_i is a unipotent block of G_i . So, there is a unique i such that A_i does not have trivial defect groups, and A is Morita equivalent to A_i .

Let us now prove the first statement of the proposition. We have $C_{\mathbf{G}}^\circ(x)^F = C_G(x)$ by [16, Proposition 13.16]. The block idempotent $\text{br}_x(b)$ gives a (nilpotent) block of $\mathcal{O}C_G(x)$ with defect group D . By [10, Theorem 3.2], this is a unipotent block. We deduce from the other part of the proposition that $D \subset Z(C_{\mathbf{G}}^\circ(x))^F$, and hence $C_{\mathbf{G}}^\circ(x) = C_{\mathbf{G}}^\circ(D)$. \square

4.2.2. *Local subgroups and characters.* Let A be a unipotent block of $\mathcal{O}G$ with a non-trivial cyclic defect group D . Let (D, b_D) be a maximal b -subpair as in §4.1.2 and let $E = N_G(D, b_D)/C_G(D)$. Recall that we assume that ℓ is odd.

Let Q be the subgroup of order ℓ of D and let $\mathbf{L} = C_{\mathbf{G}}^\circ(Q)$.

Theorem 4.6. • $\mathbf{L} = C_{\mathbf{G}}^\circ(D)$ is a Levi subgroup of \mathbf{G} .

- D is the Sylow ℓ -subgroup of $Z^\circ(\mathbf{L})^F$ and $L = D \times H$ for some subgroup H of L containing $[\mathbf{L}, \mathbf{L}]^F$.
- There is a (unique) unipotent character λ of L such that $R_L^G(\lambda) = \sum_{\chi \in \text{Uch}(KA)} \varepsilon_\chi \chi$ for some $\varepsilon_\chi \in \{\pm 1\}$.
- We have $|\text{Uch}(KA)| = |E|$ and $\text{Irr}(KA)$ is the disjoint union of $\text{Uch}(KA)$ and of $\{(-1)^{r_G+r_L} R_L^G(\lambda \otimes \xi)\}_{\xi \in (\text{Irr}(KD) - \{1\})/E}$.
- If $|E| \neq |D| - 1$, then $\text{Uch}(KA)$ is the set of non-exceptional characters of A .

Proof. Let A' be the block of $\mathcal{O}L$ corresponding to A . This is a unipotent block with defect group D . By Proposition 4.5, we have $Q \leq Z^\circ(\mathbf{L}) \neq 1$, hence \mathbf{L} is a Levi subgroup of \mathbf{G} , since it is the centralizer of the torus $Z^\circ(\mathbf{L})$. Also, D is the Sylow ℓ -subgroup of $Z^\circ(\mathbf{L})^F$ and $L = D \times H$ for some subgroup H of L containing $[\mathbf{L}, \mathbf{L}]^F$.

There is a (unique) unipotent irreducible representation λ in $\text{Irr}(KA')$ and $\text{Irr}(KA') = \{\lambda \otimes \xi\}_{\xi \in \text{Irr}(KD)}$.

Let $\xi \in \text{Irr}(KD) - \{1\}$. The character $\chi_\xi = (-1)^{r_G+r_L} R_L^G(\lambda \otimes \xi)$ is irreducible and it depends only on $\text{Ind}_D^{D \times E} \xi$ [23, Theorem 13.25]. Furthermore, $\chi_\xi = \chi_{\xi'}$ implies $\xi' \in E \cdot \xi$.

Assume that $|E| \neq |D| - 1$. There are at least two E -orbits on the set of non-trivial characters of D , so the χ_ξ for $\xi \in (\text{Irr}(KD) - \{1\})/E$ are exceptional characters. Since A and A' have the same number of exceptional characters, we have found all exceptional characters of A .

Let $\chi_1 = (-1)^{r_G+r_L} R_L^G(\lambda)$. We have $d(\chi_1) = d(\chi_\xi)$ for any $\xi \in \text{Irr}(KD) - \{1\}$. There are integers $n_\chi \in \mathbb{Z}$ such that $\chi_1 = \sum_{\psi \in \text{Uch}(KA)} n_\psi \psi$. The restriction of the decomposition map to $\mathbb{Z}\text{Uch}(KA)$ is injective, since we have removed exceptional characters (if $|E| \neq |D| - 1$, otherwise one character) from $\text{Irr}(KA)$. It follows that χ_1 is the unique linear combination of unipotent characters of A such that $d(\chi_1) = d(\xi)$ for some $\xi \in \text{Irr}(D) - \{1\}$. On the other hand, this unique solution satisfies $n_\psi = \pm 1$ and the number of unipotent characters in A' is $|E|$. \square

Remark 4.7. Choose a bijection $\text{Irr}(KE) \xrightarrow{\sim} \text{Uch}(KA')$, $\phi \mapsto \chi_\phi$. Define $I : \mathbb{Z}\text{Irr}(KD \rtimes E) \xrightarrow{\sim} \mathbb{Z}\text{Irr}(KA')$ by $I(\text{Ind}_D^{D \times E} \xi) = R_L^G(\xi)$ if $\xi \in \text{Irr}(KD) - \{1\}$ and $I(\phi) = \varepsilon_{\chi_\phi} \chi_\phi$ for $\phi \in \text{Irr}(KE)$. The proof of Theorem 4.6 above shows that I is an isotypy, with local isometries $I_x : \mathbb{Z}\text{Irr}(KD) \xrightarrow{\sim} \mathbb{Z}\text{Irr}(KA')$, $\xi \mapsto \lambda \otimes \xi$ for $x \in D - \{1\}$.

4.2.3. *Genericity.* We assume in §4.2.3 that F is a Frobenius endomorphism. Let A be a unipotent block of $\mathcal{O}G$ with a non-trivial cyclic defect group D and let $\mathbf{L} = C_{\mathbf{G}}^\circ(D)$.

Let d be the order of q modulo ℓ . Note that ℓ divides $\Phi_e(q)$ if and only if $e = d\ell^j$ for some $j \geq 0$.

Broué–Michel [11] and Cabanes–Enguehard [15] showed that under a mild additional assumption on ℓ (for quasisimple groups not of type A , ℓ good is enough), unipotent characters in ℓ -blocks with abelian defect groups are Φ_d -blocks. We show below that this results holds for ℓ -blocks with cyclic defect groups without assumptions on ℓ . Using the knowledge of generic degrees, the unipotent Φ_d -blocks with defect 1 for simple \mathbf{G} can be easily determined, using for example Chevie [61].

Theorem 4.8. *With the notations of §4.2.2, we have the following assertions:*

- \mathbf{L} is a Φ_d -split Levi subgroup of \mathbf{G} ;
- D has order $|\Phi_d(q)|_\ell$;
- $\lambda = \lambda_q$ for a unipotent Φ_d -cuspidal character λ of \mathbf{L} and there is a bijection $\text{Uch}(\mathbf{G}, (\mathbf{L}, \lambda)) \xrightarrow{\sim} \text{Uch}(KA)$ given by $\chi \mapsto \chi_q$;
- the Φ_d -block $\text{Uch}(\mathbf{G}, (\mathbf{L}, \lambda))$ has defect 1;
- if ℓ is a bad prime for \mathbf{G} or $\ell = 3$ and (\mathbf{G}, F) has type 3D_4 , then we are in one of the cases listed in Table 1.

(\mathbf{G}, F)	ℓ	d	(\mathbf{L}, λ)
$E_6(q)$	3	2	$(A_5(q) \cdot (q-1), \phi_{321})$
${}^2E_6(q)$	3	1	$({}^2A_5(q) \cdot (q+1), \phi_{321})$
$E_8(q)$	3, 5	1	$(E_7(q) \cdot (q-1), E_7[\pm i])$
$E_8(q)$	3, 5	2	$(E_7(q) \cdot (q+1), \phi_{512,11} \text{ or } \phi_{512,12})$

TABLE 1. Unipotent blocks with cyclic defect for ℓ bad

Proof. By Proposition 4.5, we can assume that \mathbf{G} is simple and simply connected. When ℓ is good and different from $\ell = 3$ for type 3D_4 , the theorem is [15].

Otherwise, the result follows from [31, Théorème A], by going through the list of d -cuspidal pairs with ℓ -central defect and checking if the defect groups given in [31, §3.2] are cyclic. We list the unipotent blocks with cyclic defect for ℓ bad in Table 1, following [31, §3.2]. Note that in [31, p.358, No 29], ‘ $E_7[\pm\xi]$ ’ should be replaced by ‘ $\phi_{512,11}, \phi_{512,12}$ ’, as in [8, Table 1, Cases 42, 43]. \square

Broué [6] conjectured that there is a parabolic subgroup \mathbf{P} with an F -stable Levi complement \mathbf{L} such that $b\mathrm{R}\Gamma_c(Y_{\mathbf{G}}(\mathbf{L} \subset \mathbf{P}), \mathcal{O})$ induces a derived equivalence between A and the corresponding block of $\mathcal{O}N_G(D, b_D)$. In [17], it is conjectured that such an equivalence should be perverse. It is further shown there how the Brauer tree of A could then be combinatorially constructed from the perversity function. The perversity function can be encoded in the data of a function $\pi : \mathrm{Uch}(KA) \rightarrow \mathbb{Z}$ that describes the (conjecturally) unique i such that $V \in \mathrm{Uch}(KA)$ occurs in $H_c^i(Y_{\mathbf{G}}(\mathbf{L} \subset \mathbf{P}), K)$.

In [19], the first author gave a conjectural description γ of the function π , depending on Φ_d and not on ℓ (this is defined for Φ_d -blocks with arbitrary defect). Using this function, and the combinatorial procedure to recover a Brauer tree from a perversity function, [19] associates a *generic Brauer tree* to a Φ_d -block of defect 1. This is a planar-embedded tree, together with an exceptional vertex (but no multiplicity) and the non-exceptional vertices are parametrized by the unipotent characters in the given Φ_d -block. The Brauer tree of A is conjectured in [19] to be obtained from the generic Brauer tree, by associating the appropriate multiplicity if it is greater than 1, and turning the exceptional vertex into a non-exceptional one if the multiplicity is 1. The trees we construct in this paper in §5 match the generic trees constructed in [19], and hence we prove the following theorem.

Theorem 4.9. *Let A be a unipotent ℓ -block with cyclic defect of G . Then the unipotent characters of KA form a unipotent Φ_d -block and the Brauer tree of A is obtained from the generic Brauer tree of that Φ_d -block.*

Since the trees constructed in §5 match the conjectural trees in [19] that would result from a perverse equivalence between $D \rtimes E$ and A , we get the following corollary.

G	d	$([\mathbf{L}, \mathbf{L}], \lambda)$	$\ell \mid L_I $
2E_6	12		
E_7	9		E_6
	10	$({}^2A_2(q), \phi_{21})$	D_6
	14		
E_8	9	$(A_2(q), \phi_3)$	E_6
		$(A_2(q), \phi_{21})$	E_6
		$(A_2(q), \phi_{13})$	E_6
	12	$({}^3D_4(q), {}^3D_4[1])$	E_6, D_7
	15		
	18	$({}^2A_2(q), \phi_{21})$	E_7
	20		
	24		

TABLE 2. Blocks with unknown Brauer tree

Corollary 4.10. *There is a perverse derived equivalence between A and $D \rtimes E$ with perversity function γ .*

4.2.4. *Determination of the trees.* Let us now discuss the known Brauer trees. The Brauer trees for classical groups were determined by Fong and Srinivasan [35, 36]. The Brauer trees for the following exceptional groups are known: Burkhart [13] for 2B_2 , Shamash [64] for G_2 , Geck [38] for 3D_4 , Hiss [47] for 2G_2 and 2F_4 , Hiss–Lübeck [48] for F_4 and 2E_6 (building on earlier work on F_4 by Wings [66]) and Hiss–Lübeck–Malle [49] for E_6 .

More recently, the second and third authors determined in [30] the Brauer trees of the principal Φ_h -block of E_7 and E_8 for h the Coxeter number, using new geometric methods which are also at the heart of this paper. Also, the first author determined in [19] the Brauer trees of several unipotent blocks with cyclic defect of E_7 and E_8 .

We determine the remaining unknown trees. They correspond to certain unipotent blocks of 2E_6 (cf. Remark 5.1), E_7 (§5.1) and E_8 (§5.2). We list in Table 2 the group G , the order d of q modulo ℓ and the d -cuspidal pair (when the block is not principal) associated to each of these blocks. We also indicate the type of the minimal proper standard F -stable Levi subgroups \mathbf{L}_I with $\ell \mid |L_I|$.

Let us note that the Brauer trees of other blocks of exceptional groups were determined up to choices of fields of character values in each block. Using Lusztig’s parametrization of unipotent characters we can remove this ambiguity by choosing appropriate roots of unity in $\overline{\mathbb{Q}}_\ell$ with respect to q .

Corollary 4.11. *Let G be a finite group with cyclic Sylow ℓ -subgroups. If $\ell \neq 29, 41, 47, 59, 71$, then the (unparametrized) Brauer tree of the principal ℓ -block of G is known.*

Proof. Let G be a finite group with a non-trivial cyclic Sylow ℓ -subgroup. Since the principal block of G is isomorphic to that of $G/O_{\ell'}(G)$, we can assume that $O_{\ell'}(G) = 1$. If G has a normal Sylow ℓ -subgroup, then the Brauer tree is a star. So, we assume G does not have a normal Sylow ℓ -subgroup. It follows from the classification of finite simple groups [34, §5] that G has a normal simple subgroup H with G/H an ℓ' -subgroup of $\text{Out}(H)$.

If H is an alternating group, the Brauer trees are foldings of those of symmetric groups, which are lines as all characters are real. If H is a sporadic group, then the Brauer tree of the principal block of H is known under the assumptions of ℓ , [50, 18].

Assume now H is a finite group of Lie type. If ℓ is the defining characteristic, then $H = \text{PSL}_2(\mathbb{F}_{\ell})$ and the Brauer tree of the principal block is well known. Otherwise, the Brauer tree is known by Theorem 4.9. \square

4.3. Properties of the trees. We assume here that \mathbf{G} is simple and we denote by A a unipotent block with cyclic defect group D of $\mathcal{O}G$. Let $E = N_G(D, b_D)/C_G(D)$, where (D, b_D) is a maximal A -subpair. We assume $|E| > 1$. We denote by T the Brauer tree of A . Recall (Theorem 4.6) that its $|E|$ unipotent vertices are non-exceptional. We define the *non-unipotent vertex* of T to be the one corresponding to the sum of the non-unipotent characters in KA . It is exceptional if $|E| \neq |D| - 1$.

4.3.1. Harish-Chandra branches. Let I be an F -stable subset of S and X be a cuspidal simple unipotent KL_I -module with central ℓ -defect, i.e., such that $(\dim X)_{\ell} = [L_I : Z(L_I)]_{\ell}$. Since the centre acts trivially on simple unipotent modules, the ℓ -block b_I of L_I containing X has central defect group, and X is the unique unipotent simple module in b_I . This yields the following three facts.

- (a) There exists a unique (up to isomorphism) $\mathcal{O}L_I$ -lattice \tilde{X} such that $X \simeq K\tilde{X}$. The kL_I -module $k\tilde{X}$ is irreducible.
- (b) X is the unique unipotent module that lifts $k\tilde{X}$. In particular $N_G(L_I, X) = N_G(L_I, k\tilde{X})$.
- (c) If P is a projective cover of \tilde{X} , then $K\text{Ker}(P \twoheadrightarrow \tilde{X})$ has only non-unipotent constituents, therefore $R_{L_I}^G(X)$ and $K\text{Ker}(R_{L_I}^G(P) \twoheadrightarrow R_{L_I}^G(\tilde{X}))$ have no irreducible constituents in common.

Under the properties (a) and (b), Geck showed in [37, 2.6.9] that the endomorphism algebra $\text{End}_{\mathcal{O}G}(R_{L_I}^G(\tilde{X}))$ is reduction-stable, i.e.

$$k\text{End}_{\mathcal{O}G}(R_{L_I}^G(\tilde{X})) \simeq \text{End}_{kG}(R_{L_I}^G(k\tilde{X})).$$

Property (c) was used by Dipper (see [26, 4.10]) to show that the decomposition matrix of $\text{End}_{\mathcal{O}G}(R_{L_I}^G(\tilde{X}))$ embeds in the decomposition matrix of b .

It follows from [39] that the full subgraph of T whose vertices are in the Harish-Chandra series defined by (L_I, X) is a union of lines. Note that [39] proves a corresponding result for blocks of Hecke algebras at roots of unity, in characteristic 0. The fact that the tree does not change when reducing modulo ℓ follows from the following two facts:

- a symmetric algebra over a discrete valuation ring that is an (indecomposable) Brauer tree algebra over the field of fractions and over the residue field has the same Brauer tree over those two fields;
- the blocks of the Hecke algebra $\text{End}_{\mathcal{O}G}(R_{L_I}^G(\tilde{X}))$ correspond to blocks of the Hecke algebra in characteristic 0 for a suitable specialization at roots of unity.

Each such line in T is called a Harish-Chandra branch. In particular, the *principal series part* of T is the full subgraph whose vertices are in the Harish-Chandra series of the trivial representation of a quasi-split torus.

Proposition 4.12. *Let N be an edge of T and let V_1 and V_2 be its vertices. Let I be a minimal F -stable subset of S such that $*R_{L_I}^G(N) \neq 0$.*

*If $\ell \nmid |L_I|$, then given $i \in \{1, 2\}$, the F -stable subset I is also minimal with respect to the property that $*R_{L_I}^G(V_i) \neq 0$.*

Proof. Let M be an $\mathcal{O}L_I$ -lattice such that KM is simple and N is a quotient of $R_{L_I}^G(M)$. Note that M is projective, hence it follows by Harish-Chandra theory that KM is cuspidal. Since $R_{L_I}^G(M)$ is projective, it follows that V_1 and V_2 are direct summands of $KR_{L_I}^G(M)$. The proposition follows by Harish-Chandra theory. \square

Corollary 4.13. *Suppose that $\ell \nmid |L_I|$ for all F -stable $I \subsetneq S$. Then the edges that are not in a Harish-Chandra branch are cuspidal.*

The following result is a weak form of [46, Theorem 3.5].

Proposition 4.14. *If St is a vertex of T , then the edge corresponding to St_ℓ connects St and the non-unipotent vertex.*

Proof. Recall that $b\Gamma_\psi$ is the projective cover of St_ℓ . Since St is the unique unipotent component of $K\Gamma_\psi$, the proposition follows. \square

Proposition 4.15. *Assume that A is the principal block and $\ell \nmid |L_I|$ for any F -stable $I \subsetneq S$. Let L be the full subgraph of T whose vertices are at distance at most r from 1. Then L is a line whose leaves are 1 and St .*

Proof. The tables in [44, Appendix F] show that the Brauer tree of the principal block of the Hecke algebra $\text{End}_{\mathcal{O}G}(R_T^G(\mathcal{O}))$ is a line with $r + 1$ vertices, with leaves corresponding to the trivial and sign characters. So, T has a full subgraph L that is a line with $r + 1$ vertices and with leaves 1 and St . Using Proposition 3.12 and duality, we deduce that all vertices at distance at most r from 1 are in L . \square

4.3.2. *Real stem.* We fix a square root of q^δ in K (specific choices will be made in Section 5). Let V be a unipotent irreducible KG -module. Let $w \in W$ such that V occurs in $H_c^i(X(w), K)$. The eigenvalues of F^δ on the V -isotypic component of $H_c^i(X(w), K)$ are of the form $\lambda_V q^{\delta j}$ where λ_V is a root of unity (depending only on V , not on w nor i), for some $j \in \frac{1}{2}\mathbb{Z}$. Note that $\lambda_{V^*} = \lambda_V^{-1}$.

So, the vertices of the real stem of T consist of the non-unipotent vertex and the unipotent vertices corresponding to the V such that $\lambda_V = \pm 1$. For classical groups, all unipotent characters have this property, and are real valued, and for exceptional groups, the unipotent characters with this property are principal-series characters and D_4 -series characters, which are real-valued by [41, Proposition 5.6], and cuspidal characters $G[\pm 1]$, which are rational-valued by [41, Table 1].

4.3.3. *Exceptional vertex.* Recall from Theorem 4.6 that the ℓ -block A is attached to a cuspidal pair (\mathbf{L}, λ) . A non-unipotent character in A is obtained by Deligne–Lusztig induction from an irreducible non-unipotent character of L . We give here a condition for that character to be cuspidal.

Proposition 4.16. *Assume that λ is cuspidal and \mathbf{L} is not contained in any proper F -stable parabolic subgroup of \mathbf{G} . Let \mathbf{P}' be a proper F -stable parabolic subgroup of \mathbf{G} with unipotent radical \mathbf{U}' and an F -stable Levi complement \mathbf{L}' . The $(\mathcal{O}G, \mathcal{O}L')$ -bimodule $b\mathcal{O}Ge_{U'}$ is projective and its restriction to $\mathcal{O}G$ is a direct sum of projective indecomposable A -modules corresponding to edges that do not contain the non-unipotent vertex.*

In particular, the non-unipotent characters of A are cuspidal.

Proof. Let Q be the subgroup of order ℓ of D and let $g \in G$ such that $Q^g \leq L$. Let $\Delta_g Q = \{(x, g^{-1}xg) | x \in Q\}$. We have $\text{Br}_{\Delta_g Q}(b\mathcal{O}Ge_{U'}) \simeq \text{Br}_{\Delta Q}(b\mathcal{O}Ge_{gU'g^{-1}}) = b_\lambda kLe_V$ where $V = gU'g^{-1} \cap L$ (Lemma 3.2). By assumption, λ is cuspidal and $\mathbf{P}' \cap \mathbf{L}$ is a proper F -stable parabolic subgroup of \mathbf{L} , hence $b_\lambda kLe_V = 0$, hence $\text{Br}_{\Delta_g Q}(b\mathcal{O}Ge_{U'}) = 0$. Since the $((\mathcal{O}G) \otimes (\mathcal{O}L')^{\text{opp}})$ -module $b\mathcal{O}G$ is a direct sum of indecomposable modules with vertices trivial or containing $\Delta_g Q$ for some $g \in G$, we deduce that the $(\mathcal{O}G, \mathcal{O}L')$ -bimodule $b\mathcal{O}Ge_{U'}$ is projective.

Let $\xi \in \text{Irr}(KD) - \{1\}$. Since $\text{Res}_{[\mathbf{L}, \mathbf{L}]^F}^L(\lambda \otimes \xi) = \text{Res}_{[\mathbf{L}, \mathbf{L}]^F}^L(\lambda)$, it follows that $\lambda \otimes \xi$ is cuspidal. Theorem 4.6 shows that every non-unipotent character of b is of the form $(-1)^{r_G + r_L}(R_L^G(\lambda \otimes \xi))$ for some $\xi \in \text{Irr}(KD) - \{1\}$. Proposition 3.1 shows that such a character is cuspidal. \square

The assumptions of Proposition 4.16 are satisfied in the following cases:

- $\mathbf{L} = \mathbf{T}$ contains a Sylow Φ_d -torus of G and d is not a reflection degree of a proper parabolic subgroup of W (e.g. $G = E_7(q)$ and $d = 14$ or $G = E_8(q)$ and $d \in \{15, 20, 24\}$). In that case the trivial character of L is cuspidal, and no proper F -stable parabolic subgroup of \mathbf{G} can contain a Sylow Φ_d -torus.
- $G = E_8(q)$, $d = 12$ and $([\mathbf{L}, \mathbf{L}]^F, \lambda) = ({}^3D_4(q), {}^3D_4[1])$ or $d = 18$ and $([\mathbf{L}, \mathbf{L}]^F, \lambda) = ({}^2A_2(q), \phi_{21})$.

Lemma 4.17. *Let $w \in W$ and let M be a simple A -module corresponding to an edge containing χ_{exc} .*

If w has minimal length such that $\text{RHom}_{kG}^\bullet(\text{R}\Gamma_c(X(w), k), M) \neq 0$, then $\ell \mid |\mathbf{T}^{wF}|$.

If $\ell \nmid |\mathbf{T}^{vF}|$ for all $v \leq w$, then $\text{RHom}_{kG}^\bullet(\text{R}\Gamma_c(X(\bar{w}), k), M) = 0$.

Proof. Let M be as in the lemma and w be minimal such that $\text{RHom}_{kG}^\bullet(\text{R}\Gamma_c(X(w), k), M) \neq 0$. Assume that $\ell \nmid |\mathbf{T}^{wF}|$. We have $(-1)^{\ell(w)}[b\text{R}\Gamma_c(X(w), k)] = \sum_{\eta} a_{\eta}[P_{\eta}]$, where η runs over the edges of T and $a_{\eta} \in \mathbb{Z}$. By Proposition 3.5 we have $a_{\mu} > 0$ where μ is the edge corresponding to M . Since χ_{exc} does not occur in $[\text{R}\Gamma_c(X(w), K)]$, it follows that there is an edge ν containing χ_{exc} such that $a_{\nu} < 0$. Let N be the simple A -module corresponding to ν . The complex $\text{RHom}_{kG}^\bullet(\text{R}\Gamma_c(X(w), k), N)$ has non-zero cohomology in a degree other than $-\ell(w)$, hence there is $v < w$ such that $\text{RHom}_{kG}^\bullet(\text{R}\Gamma_c(X(v), k), N) \neq 0$ by Proposition 3.5, a contradiction. The lemma follows. \square

4.3.4. *In the stable category.* Assume in §4.3.4 that $\delta = 1$ and \mathbf{L} is a maximal torus of \mathbf{G} . This is a Φ_d -torus. Let $w \in W$ be a d -regular element. The next result follows from [30, Corollary 2.11 and its proof].

Proposition 4.18. *Let $m \in \{0, \dots, d-1\}$. The complex $\text{R}\Gamma_c(X(w), k)_{(q^m)}$ is isomorphic in kG -stab to $\Omega^{2m}k$.*

Remark 4.19. If \mathbf{T}^{vF} is an ℓ' -group for all $v < w$, then Proposition 4.18 holds with $X(w)$ replaced by $\bar{X}(w)$.

4.3.5. *Coxeter orbits.* The following lemma holds for general symmetric \mathcal{O} -algebras A such that kA is a Brauer tree algebra.

Lemma 4.20. *Let C be a bounded complex of finitely generated projective A -modules. Assume that T has a subtree of the form*

$$V_t \xrightarrow{S_{t-1}} V_{t-1} \text{ --- } V_2 \xrightarrow{S_1} V_1 \xrightarrow{S_0} V_0$$

all of whose vertices are non-exceptional, and:

- (i) $\text{KH}^i(C) = 0$ for $i \notin \{0, -t\}$, $\text{H}^i(kC) = 0$ for $i < -t$ and $\text{KH}^0(C) \simeq V_0$;
- (ii) *given an edge M of T , given an integer $i < t$ and given a map $f \in \text{Hom}_{D^b(A)}(C, M[i])$, the induced map from the torsion part of $\text{H}^{-i}(C)$ to M vanishes;*
- (iii) *letting M be an edge of T that contains V_i , and assuming that M is strictly between S_{i-1} and S_i in the cyclic ordering of edges at V_i (for $0 < i \leq t-1$) or $M \neq S_0$ (for $i = 0$), then $\text{Hom}_{D^b(A)}(C, M[j]) = 0$ for $j \in \{i, i+1\} \cap \{0, \dots, t-1\}$;*
- (iv) S_i is not a composition factor of the torsion part of $\text{H}^{-i+1}(C)$ for $1 \leq i \leq t-1$.

Then C is homotopy equivalent to

$$0 \rightarrow P \rightarrow P_{S_{t-1}} \xrightarrow{\delta_{t-1}} P_{S_{t-2}} \rightarrow \dots \xrightarrow{\delta_1} P_{S_0} \rightarrow 0$$

where P is a projective A -module in degree $-t$ with $KP \simeq KH^{-t}(C) \oplus V_t$ and $\text{Hom}_A(P_{S_i}, P_{S_{i-1}}) = \mathcal{O}\delta_i$. Furthermore, given $i \in \{0, \dots, t-2\}$, the composition factors of the torsion part of $H^{-i}(C)$ correspond to the edges strictly between S_i and S_{i+1} in the cyclic ordering of edges at V_i .

If $V = KH^{-t}(C)$ is simple and distinct from V_{t-1} , then there is an edge S_t between V and V_t and $P \simeq P_{S_t}$. Furthermore, the composition factors of the torsion part of $H^{-t+1}(C)$ correspond to the edges strictly between S_{t-1} and S_t in the cyclic ordering of edges at V_t .

Proof. We can assume that C has no non-zero direct summand homotopic to zero. Since $H^{<-t}(kC) = 0$, it follows that $C^{<-t} = 0$. Let m be maximal such that $C^m \neq 0$. Suppose that $m > 0$. By (i), $H^m(C)$ is a non-zero torsion A -module. Let M be a simple quotient of $H^m(C)$. Assumption (ii) gives a contradiction. We deduce that $m = 0$.

By (iii), any simple quotient of $H^0(C)_{\text{free}} = H^0(C)/H^0(C)_{\text{tor}}$ is isomorphic to S_0 . Moreover, since $KH^0(C)_{\text{free}} = V_0$ and S_0 occurs only once in any ℓ -reduction of V_0 , there exists a surjective map $P_{S_0} \twoheadrightarrow H^0(C)_{\text{free}}$. It follows that there is an isomorphism $P_{S_0} \oplus Q \xrightarrow{\sim} C^0$ such that the composite map $KQ \rightarrow KC^0 \rightarrow KH^0(C)$ vanishes. Let N be the image of P_{S_0} in $H^0(C)$. Suppose that there is a simple quotient M of $H^0(C)$ vanishing on N (i.e. such that N is in the kernel of the quotient map $H^0(C) \twoheadrightarrow M$). Then M is a quotient of the torsion part of $H^0(C)$ and the composite map $Q \rightarrow H^0(C) \rightarrow M$ is non-zero. We deduce that this map induces a non-zero map from the torsion part of $H^0(C)$ to M , which contradicts (ii). Consequently the restriction of $C \rightarrow H^0(C)$ to P_{S_0} is surjective and $Q = 0$ by minimality of C .

Given $1 \leq i \leq t-1$, fix $\delta_i : P_{S_i} \rightarrow P_{S_{i-1}}$ such that $\text{Hom}_A(P_{S_i}, P_{S_{i-1}}) = \mathcal{O}\delta_i$. We put $\delta_0 = 0 : P_{S_0} \rightarrow 0$. We prove by induction on $i \in \{0, \dots, t-1\}$ that $0 \rightarrow C^{-i} \rightarrow C^{-i+1} \rightarrow \dots$ is isomorphic to the complex $0 \rightarrow P_{S_i} \xrightarrow{\delta_i} P_{S_{i-1}} \rightarrow \dots \rightarrow P_{S_1} \xrightarrow{\delta_1} P_{S_0} \rightarrow 0$, where P_{S_0} is in degree 0. This holds for $i = 0$ and we assume now this holds for some $i \leq t-2$. We have $\dim \text{Hom}_{kA}(kP_{S_{i+1}}, kP_{S_i}) = 1$ and we denote by N the image of a non-zero map $P_{S_{i+1}} \rightarrow P_{S_i}$. It is contained in $k \ker \delta_i$. Let M be a composition factor of $(k \ker \delta_i)/N$. If $i = 0$, then the edge corresponding to M contains V_0 and $M \neq S_0$ or it contains V_1 and is strictly between S_0 and S_1 in the cyclic ordering of edges at V_1 . If $i > 0$, then the edge corresponding to M contains V_i and is strictly between S_{i-1} and S_i in the cyclic ordering of edges at V_i or it contains V_{i+1} and is strictly between S_i and S_{i+1} in the cyclic ordering of edges at V_{i+1} . By (iii), P_M is not a direct summand of C^{-i-1} . It follows from (iv) that there is an isomorphism $P_{S_{i+1}} \oplus Q \xrightarrow{\sim} C^{-i-1}$ such that the composition $Q \rightarrow C^{-i-1} \rightarrow C^{-i}$ vanishes. Let M be a simple quotient of Q . By minimality of C , M occurs as a quotient of $H^{-i-1}(C)$, which is torsion by (i). So (ii) gives a contradiction. We

deduce that $C^{-i-1} \simeq P_{S_{i+1}}$ and the differential $kC^{-i-1} \rightarrow kC^{-i}$ is not zero. This shows that the induction statement holds for $i + 1$.

We deduce that C is isomorphic to

$$0 \rightarrow P \rightarrow P_{S_{t-1}} \xrightarrow{\delta_{t-1}} P_{S_{t-2}} \rightarrow \cdots \rightarrow P_{S_1} \xrightarrow{\delta_1} P_{S_0} \rightarrow 0$$

for some projective A -module P in degree $-t$. We have $[KP] = (-1)^t[KC] + [KP_{S_{t-1}}] - [KP_{S_{t-2}}] + \cdots + (-1)^t[KP_{S_0}] = [KH^{-t}(C)] + [V_t]$, hence $KP \simeq KH^{-t}(C) \oplus V_t$.

If $V = KH^{-t}(C)$ is simple, then $KP \simeq V \oplus V_t$, hence $P \simeq P_{S_t}$ where S_t is the edge containing V and V_t . The last statement follows from the fact that the differential $kP \rightarrow kP_{S_{t-1}}$ is non-zero. \square

The following theorem deals with direct summands of $\widetilde{\mathbf{R}}\Gamma_c(X(c), \mathcal{O})$ that have exactly two non-zero cohomology groups over K . Extra assumptions on the block are needed here.

Theorem 4.21. *Assume that $\ell \nmid |\mathbf{T}^{cF}|$. Let C be a direct summand of $\widetilde{\mathbf{R}}\Gamma_c(X(c), \mathcal{O})$ in $\mathrm{Ho}^b(\mathcal{O}G\text{-mod})$. Suppose that there are $r' \geq r$ and $t > 0$ such that*

- (i) *the torsion part in $H^*(C)$ is cuspidal,*
- (ii) *$H^i(KC) = 0$ for $i \notin \{r', r' + t\}$ and $V_0 = H^{r'+t}(KC)$ and $V' = H^{r'}(KC)$ are simple KG -modules, and*
- (iii) *T has a subgraph with non-exceptional vertices and non-cuspidal edges*

$$V_t \xrightarrow{S_{t-1}} V_{t-1} \text{ --- } V_2 \xrightarrow{S_1} V_1 \xrightarrow{S_0} V_0$$

such that $V_{t-1} \text{ --- } V_2 \xrightarrow{S_1} V_1 \xrightarrow{S_0} V_0$ is a connected component of the subgraph of T obtained by removing the edge S_{t-1} and all cuspidal edges.

Then:

- *there is an edge S_t between V_t and V' and C is homotopy equivalent to*

$$C' = 0 \longrightarrow P_{S_t} \longrightarrow P_{S_{t-1}} \longrightarrow \cdots \longrightarrow P_{S_0} \longrightarrow 0$$

with P_{S_i} in degree r' ;

- *the complex C' is, up to isomorphism, the unique complex such that the differential $P_{S_i} \rightarrow P_{S_{i-1}}$ generates the \mathcal{O} -module $\mathrm{Hom}(P_{S_i}, P_{S_{i-1}})$ for $1 \leq i \leq t$;*
- *the composition factors of the torsion part of $H^{r'+t-i}(C)$ correspond to the edges strictly between S_i and S_{i+1} in the cyclic ordering of edges at V_{i+1} (for $0 \leq i \leq t-1$). In particular, the edges between S_{t-1} and S_t around V_t are also cuspidal.*

Proof. We apply Lemma 4.20 to $C[r' + t]$. Assumptions (i), (ii) and (iv) of the lemma follow from the assumptions of the theorem. By Corollary 3.13, we have $\mathrm{Hom}_{D^b(A)}(C, M[i]) = 0$ for $i > r$ and M cuspidal. If M is simple non-cuspidal and

not in $\{S_0, \dots, S_{t-1}\}$, then M does not occur as a composition factor of $H^i(kC)$ for $i > r'$. This shows that Assumption (iii) of the lemma holds. The theorem follows. \square

Assumption (iii) in Theorem 4.21 may look rather difficult to check if only part of the tree is known. However, it will be satisfied for most of the Brauer trees we will consider, thanks to the following proposition.

Proposition 4.22. *Let V be a simple unipotent KA -module. Assume that*

- $\ell \nmid |\mathbf{T}^{cF}|$,
- V is a leaf of T , i.e. V remains irreducible after ℓ -reduction,
- the Harish-Chandra branch of V has at least t edges, and
- $\ell \nmid |L_I|$ for all F -stable subsets $I \subsetneq S$.

Then assumptions (i) and (iii) in Theorem 4.21 are satisfied with $C = b\widetilde{R}\Gamma_c(X(c), \mathcal{O})$ and $V_t, \dots, V_0 = V$ being the Harish-Chandra branch ending at the leaf V .

Proof. Assumption (i) is satisfied by Proposition 3.15, while assumption (iii) is satisfied by Corollary 4.13. \square

Corollary 4.23. *Let b be the block idempotent of the principal block of $\mathcal{O}G$. Assume that $\ell \nmid |\mathbf{T}^{cF}|$ and $\ell \nmid |L_I|$ for all F -stable subsets $I \subsetneq S$.*

Let T' be the full subgraph of T with vertices at distance at most $r+1$ of the trivial character.

- The real stem of T' is a line with leaves 1 and the non-unipotent vertex
- the edge St_ℓ has vertices St and the non-unipotent vertex
- any non-real vertex of T' is connected to St by an edge
- $V = KH_c^r(X(c), \mathcal{O})_{(q^r)}$ is a non-real simple KGb -module and the edge connecting V and St comes between the one connecting St to a unipotent vertex and St_ℓ in the cyclic ordering of edges at St .

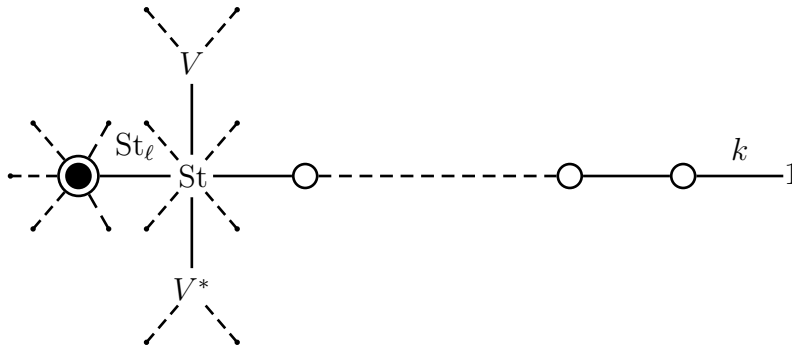

Proof. The description of Frobenius eigenvalues on the cohomology of $X(c)$ in [55, (7.3)] shows that $KH_c^i(X(c), \mathcal{O})_{(q^r)} = 0$ for $i \notin \{r, 2r\}$ and $V = KH_c^r(X(c), \mathcal{O})_{(q^r)}$ is simple, under our assumptions on ℓ . The result follows now from Theorem 4.21, Corollary 4.22 and Propositions 4.15 and 3.11(iii). \square

By Remark 3.9, the previous results have a counterpart for the compactification.

Proposition 4.24. *Lemma 3.14, Theorem 4.21, Proposition 4.22 and Corollary 4.23 hold with $\bar{X}(c)$ instead of $X(c)$ if we replace the assumption $\ell \nmid |\mathbf{T}^{cF}|$ by $\ell \nmid |\mathbf{T}^{vF}|$ for all $v \leq c$.*

Remark 4.25. We have $|\mathbf{T}^{cF}| = (q+1)(q^6 - q^3 + 1) = \Phi_2(q)\Phi_{18}(q)$ for \mathbf{G} simple of type $E_7(q)$, and $|\mathbf{T}^{cF}| = q^8 + q^7 - q^5 - q^4 - q^3 + q + 1 = \Phi_{30}(q)$ for \mathbf{G} simple of type $E_8(q)$. In particular, when ℓ is good and $d \notin \{2, h\}$, the condition $\ell \nmid |\mathbf{T}^{cF}|$ will always be satisfied for $E_7(q)$ and $E_8(q)$.

Remark 4.26. We can easily read off the cohomology of a complex C as in Theorem 4.21 from the Brauer tree. As a consequence of Theorem 4.9, one can check that the cohomology of C is concentrated in degrees r and $r+t$ (and irreducible in degree $r+t$), and is torsion-free. Other calculations in §5 give a strong evidence that the cohomology of a variety associated to a Coxeter element is always torsion-free. By [4] this holds for groups of type A . Such a statement does not hold for more general Deligne–Lusztig varieties: if $H_c^{2\ell(w)-1}(X(w), K) = 0$ and ℓ divides $|\mathbf{T}^{wF}|$, then $H_c^{2\ell(w)-1}(X(w), k) = H^1(X(w), k)^*$ is non-zero since the connected Galois covering $Y(\dot{w}) \twoheadrightarrow X(w)$ yields non-trivial connected abelian ℓ -coverings. Therefore by the universal coefficient theorem, $H_c^{2\ell(w)-1}(X(w), \mathcal{O})$ is a torsion module. However, one can ask whether the property $\ell \nmid |\mathbf{T}^{wF}|$ forces the cohomology to be torsion-free (see also Proposition 3.8).

4.4. Summary of the algebraic methods. We summarize here some facts and arguments about Brauer trees that we shall use throughout §5. We consider a unipotent block with a cyclic defect group and non-trivial automizer. We also assume that the block is real (this is the case for all the unipotent blocks we will consider).

(Parity) The distance between two unipotent vertices is even if and only if their degree are congruent modulo ℓ .

(Real stem) The collection of unipotent vertices V with $\lambda_V = \pm 1$, together with the non-unipotent vertex, form a subgraph of the Brauer tree in the shape of a line, called the *real stem*. Taking duals of characters corresponds to a reflection of the tree in the real stem.

(Hecke) The union of the full subgraphs of T obtained by considering unipotent characters in a given Harish-Chandra series is a collection of lines, which is known.

(Degree) The dimension of the simple module corresponding to an edge is the alternating sum of the degrees of the vertices in a minimal path from the edge to a leaf. This dimension is a positive integer, and this can be used to show that certain configurations are not possible. Broadly speaking, the effect of this condition is to force the degrees of the unipotent characters, as polynomials in q , to increase towards the non-unipotent node.

(Steinberg) The vertices of the edge St_ℓ are St and the non-unipotent vertex. If the proper standard Levi subgroups of G are ℓ' -groups, then the full subgraph of T whose vertices are at distance at most r from 1 is a line whose leaves are 1 and St and the edge St_ℓ is cuspidal.

Our strategy is to first study the ‘mod- ℓ generalized eigenspaces’ of F on the complex of cohomology of a Coxeter Deligne–Lusztig variety (or its compactification), for those eigenvalues corresponding to unipotent cuspidal KG -modules. This gives information about the location of the corresponding vertex with respect to the real stem.

A second step is required if there are cuspidal unipotent KG -modules in the block that do not occur in the cohomology of a Coxeter Deligne–Lusztig variety. In that case, we consider the eigenspaces in the complex of cohomology of a Deligne–Lusztig variety associated to a d -regular element, which is minimal for the property that this module occurs in the cohomology.

5. DETERMINATION OF THE TREES

We now determine the Brauer trees of the blocks from Table 2. The edges corresponding to cuspidal simple modules will be drawn as double lines.

Throughout this section, A denotes a block of $\mathcal{O}G$ with cyclic defect and b is the corresponding block idempotent.

We shall start with the case of exceptional groups of type E_7 and E_8 , for which $\delta = 1$. If G is a standard Levi of a simple group of type E_8 , it follows from Lusztig’s classification that a cuspidal unipotent character ρ of G is uniquely determined by the eigenvalue of F on the ρ -isotypic part of the cohomology of the various Deligne–Lusztig varieties. Following the convention in Chevie [61], we will denote by $G[\alpha]$ a cuspidal simple unipotent KG -module such that the eigenvalues of F in the $G[\alpha]$ -isotypic component of $H_c^*(X(w), K)$ are in $q^{\frac{1}{2}\mathbb{Z}}\alpha$ for any $w \in W$, with the exception of the cuspidal unipotent character of $D_4(q)$ which will be denoted by D_4 and not $D_4[-1]$. The choice of a square root of q is actually only needed when considering the two cuspidal characters of $E_7(q)$. The roots of unity α which occur has always order 6 or less.

For the Φ_d -blocks we will study it will be enough to consider the following situations.

- If $3 \mid d$ (resp. $4 \mid d$, $5 \mid d$), we denote by θ (resp. i , η) the unique third (resp. fourth, fifth) root of unity in \mathcal{O} whose image in k is $q^{d/3}$ (resp. $q^{d/4}$, $q^{d/5}$). The corresponding cuspidal characters are $E_6[\pm\theta]$, $E_6[\pm\theta^2]$, $E_8[\pm\theta]$ and $E_8[\pm\theta^2]$ (resp. $E_8[\pm i]$, $E_8[\eta^j]$ for $j = 1, \dots, 4$).
- If $d = 2e$ with e odd, we fix a square root \sqrt{q} of q in \mathcal{O}^\times and we denote by i the unique fourth root of unity in \mathcal{O} whose image in k is $(\sqrt{q})^e$. The corresponding cuspidal characters are $E_7[\pm i]$.

5.1. **Groups of type E_7 .** For groups of type E_7 , we need to consider the principal Φ_d -blocks for $d = 9, 14$ and the Φ_{10} -block corresponding to the d -cuspidal pair $({}^2A_2(q).(q^5 + 1), \phi_{21})$.

5.1.1. $d = 14$. In that case, the proper Levi subgroups of G are ℓ' -groups. Let us determine the Brauer tree of the principal Φ_{14} -block of $E_7(q)$. Using (Hecke), (Degree) and (Steinberg) arguments, we obtain the real stem as shown in Figure 11 (see the Appendix). The difficult part is to locate the two complex conjugate cuspidal unipotent characters. Let $C = b\tilde{R}\Gamma_c(X(c), \mathcal{O})_{(-1)}$ be the generalized ‘ -1 (mod ℓ)-eigenspace’ of F . By [55, Table 7.3], we have

$$KC \simeq (E_7[i])[-7] \oplus K[-14],$$

where $E_7[i]$ is defined as the unipotent cuspidal KG -module that appears with an eigenvalue of F congruent to -1 modulo ℓ in $H_c^7(X(c), K)$.

Corollary 4.23 shows that $E_7[i]$ is connected to St and that it is the first edge coming after the edge S_6 in the cyclic ordering of edges containing St . This completes the determination of the tree.

Let us describe more explicitly the minimal representative of the complex C . Let $k = S_0, S_1, \dots, S_6$ be the non-cuspidal modules forming the path from the characters 1 (the character of the trivial KG -module K) to St in the tree (see Figure 1).

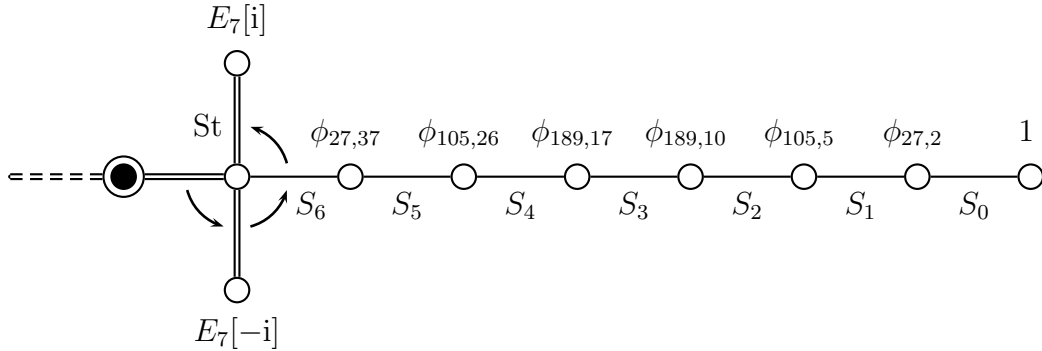

FIGURE 1. Right-hand side of the Brauer tree of the principal Φ_{14} -block of $E_7(q)$

The complex $b\tilde{R}\Gamma_c(X(c), k)_{(-1)}^{\text{red}}$ is given as follows:

$$0 \longrightarrow \begin{array}{c} E_7[i] \\ \text{St}_\ell \\ E_7[-i] \\ S_6 \\ \boxed{E_7[i]} \end{array} \longrightarrow \begin{array}{c} S_6 \\ E_7[i] \\ \text{St}_\ell \\ E_7[-i] \\ S_6 \end{array} \xrightarrow{S_5} \begin{array}{c} S_5 \\ S_6 \\ S_4 \\ S_5 \end{array} \longrightarrow \begin{array}{c} S_4 \\ S_5 \\ S_3 \\ S_4 \end{array} \longrightarrow \cdots \longrightarrow \begin{array}{c} \boxed{k} \\ S_1 \\ k \end{array} \longrightarrow 0.$$

Remark 5.1. This argument applies to many other trees, especially to those associated to the principal Φ_d -block when d is the largest degree of W distinct from the Coxeter number (in that case the assumptions on ℓ in Proposition 4.22 are satisfied). This shows for example that the Brauer tree of the principal Φ_{12} -block of ${}^2E_6(q)$ given in [48] is valid without any restriction on q . It is also worth mentioning that it gives not only the planar embedding but also the labelling of the vertices with respect to Lusztig's classification of unipotent characters (in terms of eigenvalues of Frobenius). In the previous example $\text{Ext}_{kG}^1(E_7[i], \text{St}_\ell) \neq 0$ whereas $\text{Ext}_{kG}^1(E_7[-i], \text{St}_\ell) = 0$.

5.1.2. $d = 9$. It follows from Lemma 3.3 that A is Harish-Chandra projective relatively to the principal block of $E_6(q)$, hence A has no cuspidal simple modules.

The real stem gives most of the Brauer tree of the principal ℓ -block (see Figure 9). It remains to locate the pairs of complex conjugate characters $\{E_6[\theta]_\varepsilon, E_6[\theta^2]_\varepsilon\}$ and $\{E_6[\theta]_1, E_6[\theta^2]_1\}$. To this end we use the homological information contained in the cohomology of the Coxeter variety $X(c)$. Let I be a proper subset of S . If \mathbf{L}_I is not a group of type E_6 , then L_I is an ℓ' -group and the cohomology of $X(c_I)$ is torsion-free by [29, Proposition 3.1]. This remains true when \mathbf{L}_I has type E_6 .

Lemma 5.2. *If q has order 9 modulo ℓ , the cohomology of the Coxeter variety in a simple group of type E_6 is torsion-free.*

Proof. Denote by X the Coxeter variety of $E_6(q)$. By Proposition 3.15, the torsion of $H_c^*(X, \mathcal{O})$ is cuspidal. Let $\lambda \in k^\times$ and let $C_\lambda = R\Gamma_c(X, \mathcal{O})_{(\lambda)}$.

Assume that $\lambda \notin \{1, q^6\}$. The cohomology of $H^*(KC_\lambda)$ is an irreducible module V corresponding to a block idempotent b_λ of defect zero.

If V is cuspidal, then it occurs in degree 6 in $H^*(KC_\lambda)$, hence $H^*(C_\lambda)$ is torsion-free by Lemma 3.14. If V is not cuspidal, then $H^*(b_\lambda C_\lambda)$ has no torsion. On the other hand, $H^*((1 - b_\lambda)C_\lambda)$ is torsion and cuspidal, hence 0 by Lemma 3.14.

Assume now that $\lambda = 1$. We have $H^6(KC_1) = \text{St} \oplus E_6[\theta^2]$ and $H^i(KC_1) = 0$ for $i \neq 6$, so $H^*(C_1)$ is torsion-free by Lemma 3.14 (so, $\text{St} + E_6[\theta^2]$ is a projective character of $E_6(q)$, as was shown in [49]).

Assume finally that $\lambda = q^6$. We have $H^6(KC_\lambda) = E_6[\theta]$, $H^{12}(KC_\lambda) = 1$ and $H^i(KC_\lambda) = 0$ for $i \notin \{6, 12\}$. Corollary 4.23 shows that $H^*(C_\lambda)$ is torsion-free. \square

From this lemma together with Proposition 3.15, we deduce that the torsion of $H_c^*(X(c), \mathcal{O})$ is cuspidal, hence the principal block part of $H_c^*(X(c), \mathcal{O})$ is torsion-free. In particular, the complexes $D_\lambda = bR\Gamma_c(X(c), \mathcal{O})_{(\lambda)}$ for $\lambda \in \{q^6, q^7\}$ have no torsion in their cohomology. We have

$$\begin{aligned} KD_{q^6} &\simeq E_6[\theta]_\varepsilon[-7] \oplus \phi_{7,1}[-13], \\ KD_{q^7} &\simeq E_6[\theta]_1[-8] \oplus K[-14]. \end{aligned}$$

Theorem 4.21 gives the planar-embedded Brauer tree as shown in Figure 9.

5.1.3. $d = 10$. For the Φ_{10} -block the situation is similar: there is a unique proper F -stable subset I of S such that L_I is not an ℓ' -group. This Levi subgroup \mathbf{L}_I has type D_6 . Since the Coxeter number of D_6 is 10, [29, Theorem] asserts that $H_c^*(X_{\mathbf{L}_I}(c_I), \mathcal{O})$ is torsion-free. Let $E_7[i]$ be the unipotent cuspidal KG -module that appears with eigenvalue congruent to q^6 modulo ℓ in $H_c^7(X(c), K)$. Theorem 4.21 applied to $C = b\tilde{R}\Gamma_c(X(c), k)_{(q^6)}$ gives the planar-embedded Brauer tree as shown in Figure 10.

5.2. **Groups of type E_8 .** The blocks we need to consider are:

- the three Φ_9 -blocks associated to the d -cuspidal pairs $(A_2.(q^6 + q^3 + 1), \phi)$ for $\phi = \phi_3, \phi_{21}$ and ϕ_{13} ;
- the Φ_{12} -block associated to the d -cuspidal pair $({}^3D_4(q).(q^4 + q^2 + 1), {}^3D_4[1])$;
- the Φ_{18} -block associated to the d -cuspidal pair $({}^2A_2(q).(q^6 - q^3 + 1), \phi_{21})$;
- the principal Φ_d -blocks for $d = 15, 20$ and 24 . In those cases, the proper Levi subgroups of G are ℓ' -groups.

5.2.1. $d = 9$. There are three unipotent blocks with non-trivial cyclic defect. The real stem is given by Figure 9, where we have given the correspondence with vertices of the E_7 tree. For each of the three trees, there are two pairs of complex conjugate characters that need to be located, namely:

- (1) $\{E_6[\theta]_{\phi_{1,0}}, E_6[\theta^2]_{\phi_{1,0}}\}$ and $\{E_6[\theta]_{\phi'_{1,3}}, E_6[\theta^2]_{\phi'_{1,3}}\}$ for the block b_1 associated to the d -cuspidal pair (A_2, ϕ_3) ;
- (2) $\{E_6[\theta]_{\phi_{2,1}}, E_6[\theta^2]_{\phi_{2,1}}\}$ and $\{E_6[\theta]_{\phi_{2,2}}, E_6[\theta^2]_{\phi_{2,2}}\}$ for the block b_2 associated to the d -cuspidal pair (A_2, ϕ_{21}) ;
- (3) $\{E_6[\theta]_{\phi_{1,6}}, E_6[\theta^2]_{\phi_{1,6}}\}$ and $\{E_6[\theta]_{\phi'_{1,3}}, E_6[\theta^2]_{\phi'_{1,3}}\}$ for the block b_3 associated to the d -cuspidal pair (A_2, ϕ_{13}) .

To this end we again use the cohomology of the Coxeter variety $X(c)$, which we first show to be torsion-free on each block b_i . Lemma 3.3 shows that all three unipotent blocks are Harish-Chandra projective relative to the principal block of $E_6(q)$. By Lemma 5.2, the cohomology of the Coxeter variety of E_6 is torsion-free. Therefore by Proposition 3.15 the cohomology of $X(c)$, cut by the sum of the b_i , is torsion-free.

We can now use the same argument as for the principal Φ_9 -block of E_7 : Theorem 4.21 shows that the part of the tree to the right of the non-unipotent node in Figure 9 is correct. We consider the standard Levi subgroup L_I of semisimple type E_7 and we use the Harish-Chandra induction of the isomorphism $E_6[\theta]_1 \simeq \Omega^7 \mathcal{O}$ in $\mathcal{O}L_I$ -mod. It gives

$$E_6[\theta]_1 \oplus E_6[\theta]_{\phi_{2,1}} \oplus E_6[\theta]_{\phi_{2,2}} \oplus E_6[\theta]_{\phi'_{1,3}} \simeq \Omega^7(\mathcal{O} \oplus \phi_{8,1} \oplus \phi_{35,2} \oplus \phi_{112,3})$$

in $\mathcal{O}G$ -stab. By cutting by each b_i and using the information above (on the part of the tree to the right of the non-unipotent node) we get $E_6[\theta]_{\phi_{2,2}} \simeq \Omega^7 \phi_{35,2}$ and $E_6[\theta]_{\phi'_{1,3}} \simeq \Omega^7 \phi_{112,3}$. The same procedure starting with the isomorphism $E_6[\theta]_\varepsilon \simeq$

$\Omega^7\phi_{7,1}$ yields $E_6[\theta]_{\phi_{1,3}''} \simeq \Omega^7\phi_{160,7}$. This completes the determination of the three planar-embedded trees.

Note that even though each of these three blocks is Morita equivalent to the principal Φ_9 -block of E_7 , the Harish-Chandra induction functor (cut by each block) does not induce that equivalence.

5.2.2. $d = 12$. The real stem is as given in Figure 12, therefore knowing the tree amounts to locating the cuspidal character $E_8[-\theta^2]$.

Let $C = b\widetilde{\text{R}}\Gamma_c(X(c), \mathcal{O})_{(q^6)}$. The non-cuspidal simple A -modules are in the principal series, hence they cannot occur in the torsion of $H_c^*(X(c), \mathcal{O})$. It follows that Assumption (i) of Theorem 4.21 is satisfied. Assumption (iii) follows from the knowledge of the real stem of the tree. Finally, Assumption (ii) follows from the decomposition

$$bH_c^*(X(c), K)_{(q^6)} \simeq E_8[-\theta^2][-8] \oplus \phi_{28,8}[-14].$$

Theorem 4.21 shows that Figure 12 gives the correct planar-embedded Brauer tree.

5.2.3. $d = 18$. The real stem is as in Figure 14.

- Step 1: position of $E_8[-\theta^2]$.

The only proper standard F -stable Levi subgroup \mathbf{L}_I with $\ell \mid |L_I|$ has type E_7 . It follows from Proposition 4.16 that $bR_{L_I}^G(M)$ is projective for any $M \in \mathcal{O}L_I\text{-mod}$. Since 18 is the Coxeter number of E_7 , [29, §4.3] shows that the cohomology of the perfect complex $b\text{R}\Gamma_c(X(c_I), \mathcal{O})$ is torsion-free. It follows from Proposition 3.15 that the torsion of $bH_c^*(X(c), \mathcal{O})$ is cuspidal. Since

$$bKH_c^*(X(c), K)_{(q^7)} = (E_8[-\theta^2])[-8] \oplus \phi_{8,1}[-15],$$

Proposition 4.22 and Theorem 4.21 show that there is an edge between $\phi_{35,74}$ and $E_8[-\theta^2]$, and that edge comes between the edges $\phi_{35,74} \text{ --- } \phi_{300,44}$ and $\phi_{35,74} \text{ --- } \phi_{8,91}$ in the cyclic ordering of edges around $\phi_{35,74}$.

- Step 2: $E_8[\theta]$ is connected to the non-unipotent node.

From the Brauer tree of the principal Φ_{18} -block given in [19], we know that $\Omega^{12}k$ lifts to an $\mathcal{O}G$ -lattice of character $E_6[\theta]_1$. Now, if $E_8[\theta]$ is not connected to the non-unipotent node, then $\Omega^{12}\phi_{8,1}$ lifts to an $\mathcal{O}G$ -lattice of character $D_{4,\phi_{1,12}''}$ or $\phi_{8,91}$ depending on whether $E_8[\theta]$ is connected to the D_4 -series or the principal series. Since the degree of $\phi_{8,1} \otimes E_6[\theta]_1$ is smaller than that of $\phi_{8,91}$ and of $D_{4,\phi_{1,12}''}$, we obtain a contradiction. This proves that $E_8[\theta]$ and $E_8[\theta^2]$ are connected to the non-unipotent node, and we obtain the planar-embedded Brauer tree up to swapping these two characters (see Figure 14).

- Step 3: description of $b\text{R}\Gamma_c(\overline{X}(c), \mathcal{O})_{(q)}$.

Let $C = b\widetilde{\text{R}}\Gamma_c(\overline{X}(c), \mathcal{O})_{(q)}^{\text{red}}$. Its cohomology over K is given by

$$KC \simeq (\phi_{8,1}^{\oplus 7} \oplus \phi_{35,2}^{\oplus 14} \oplus \phi_{300,8}^{\oplus 10} \oplus \phi_{840,13}^{\oplus 4})[-2] \oplus (E_8[-\theta])[-8].$$

Corollary 3.13 (or rather its analogue for compactifications, which holds since $\ell \nmid \mathbf{T}^{vF}$ for all $v \leq c$, see also Remark 3.6) shows that the terms of C are projective and do not involve the projective cover of a cuspidal module, except possibly in degree 8. The character of KC shows that only the projective cover of $E_8[-\theta]$ can occur, and it occurs once in degree 8. In addition, the torsion of the cohomology of C must be cuspidal by Proposition 3.8 (there are no modules lying in an E_7 -series in b). Let $i < 2$ be minimal such that $H^i(kC) \neq 0$. Then $H^i(kC)$ is cuspidal and $(kC)^i$ contains an injective hull of $H^i(kC)$, a contradiction. So, $H^i(kC) = 0$ for $i < 2$. Let P_0, \dots, P_7 be the projective indecomposable modules lying in the principal series of A , with $[P_0] = \phi_{8,1} + \phi_{35,2}$ and $\text{Hom}(P_i, P_{i+1}) \neq 0$ for $0 \leq i < 7$, so that $[P_7] = \phi_{35,74} + \phi_{8,91}$. It follows from Lemma 4.20 that

$$(5.1) \quad C \simeq 0 \rightarrow P \rightarrow P_2 \rightarrow \dots \rightarrow P_6 \rightarrow P_{E_8[-\theta]} \rightarrow 0$$

where $P \simeq P_0^{\oplus 7} \oplus P_1^{\oplus 7} \oplus P_2^{\oplus 4}$ is in degree 2.

- Step 4: the torsion part of $b\text{R}\Gamma_c(\overline{X}(w), \mathcal{O})_{(q)}$ is cuspidal.

Let $w \in W$ be the unique (up to conjugation) element of minimal length for which $E_8[\theta]$ occurs in $H_c^*(X(w))$. Here $\ell(w) = 14$. Let us consider $R = b\text{R}\Gamma_c(\overline{X}(w), \mathcal{O})_{(q)}$. Using the trace formula (see [25, Corollaire 3.3.8]), we find that

$$KR \simeq (\phi_{8,1}^{\oplus 4} \oplus \phi_{35,2}^{\oplus 6} \oplus \phi_{300,8}^{\oplus 3} \oplus \phi_{840,13})[-2] \oplus (E_8[\theta^2])[-14].$$

By Proposition 3.8, the torsion-part of the cohomology in R is either cuspidal or in an E_7 -series. Since there are no modules in E_7 -series in A , we deduce that the torsion part is cuspidal. In particular, if $j = 4, 5, 6$ then $\text{Hom}_{kG}^\bullet(P_j, kR) \simeq 0$, and if $j = 0, \dots, 3$ the cohomology of $\text{Hom}_{kG}^\bullet(P_j, kR)$ vanishes outside degree 2. Note that $\text{Hom}_{kG}^\bullet(P_j, kR) \simeq P_j \otimes_{kG} kR$ where P_j is viewed as a right kG -module via the anti-automorphism $g \mapsto g^{-1}$ of G , since P_j is self-dual.

- Step 5: $E_8[-\theta^2]$ is not a composition factor of $H^*(kR)$.

Let C' be the cone of the canonical map $P_{E_8[-\theta]}[-8] \rightarrow kC$. By (5.1) it is homotopic to a complex involving only projective modules in the principal series. Tensoring by kR gives a distinguished triangle

$$P_{E_8[-\theta]}[-8] \otimes_{kG} kR \rightarrow kC \otimes_{kG} kR \rightarrow C' \otimes_{kG} kR \rightsquigarrow .$$

From the explicit representative of C' and step 4 above we know that the cohomology of $C' \otimes_{kG} kR$ vanishes outside the degrees 4, 5 and 6. Proposition 3.7 shows that the cohomology of $kC \otimes_{kG} kR$ vanishes outside degree 4. The previous distinguished triangle shows that the cohomology of $P_{E_8[-\theta]} \otimes_{kG} kR$ vanishes outside the degrees $-4, \dots, -1$. Since $H^i(kR) = 0$ for $i < 0$ this proves that $E_8[-\theta^2]$ is not a composition factor of $H^*(kR)$.

- Step 6: $E_8[-\theta]$ is not a composition factor of $H^i(kR)$ for $i \neq 6, 7, 8$.

The same method as in Step 5 with $D = b\mathrm{R}\Gamma_c(\overline{X}(c), \mathcal{O})_{(q^7)} \simeq C^*[-16]$ and $D' = \mathrm{Cone}(kD \rightarrow P_{E_8[-\theta^2]}[-8])$ yields a distinguished triangle

$$kD \otimes_{kG} kR \rightarrow P_{E_8[-\theta^2]}[-8] \otimes_{kG} kR \rightarrow D' \otimes_{kG} kR \rightsquigarrow .$$

Here $kD \otimes_{kG} R$ has non-zero cohomology only in degree 16 by Proposition 3.7. As for $D' \otimes_{kG} kR$, its cohomology vanishes outside the degrees 14, 15 and 16, and we deduce from the distinguished triangle that $E_8[-\theta]$ is not a composition factor of $H^i(kR)$ for $i \neq 6, 7, 8$.

If $v < w$ and $\ell \mid |\mathbf{T}^{vF}|$, then v is conjugate to c_I , the Coxeter element of type E_7 . Since $b\mathrm{R}\Gamma_c(X(c_I), \mathcal{O})$ is perfect, it follows from Lemma 3.10 that $b\mathrm{R}\Gamma_c(X(v), \mathcal{O})$ is perfect for all $v < w$.

- Step 7: given $v < w$, the complex $b\mathrm{R}\Gamma_c(X(v), k)$ is quasi-isomorphic to a bounded complex of projective modules whose indecomposable summands correspond to edges that do not contain the non-unipotent vertex.

Consider $v < w$. If v is not conjugate to a Coxeter element c_I of E_7 , then $\ell \nmid |\mathbf{T}^{vF}|$ and $b\mathrm{R}\Gamma_c(X(v), k)$ is perfect and quasi-isomorphic to a bounded complex of projective modules whose indecomposable summands correspond to edges that do not contain the non-unipotent vertex by Lemma 4.17. If $v = c_I$, the perfectness has been shown in Step 1 and the second part holds, because the edges that contain the non-unipotent vertex are cuspidal. We deduce that the statement of Step 7 holds for all $v < w$ by Lemma 3.10.

- Step 8: $H^{>14}(R) = 0$.

Steps 4, 5 and 6 show that the composition factors of $H^i(kR)$ for $i > 14$ are cuspidal modules M corresponding to an edge containing the non-unipotent vertex. Let M be a simple module corresponding to an edge containing the non-unipotent vertex. Step 7 shows that the canonical map $\mathrm{R}\Gamma(\overline{X}(w), k) \rightarrow \mathrm{R}\Gamma(X(w), k)$ induces an isomorphism

$$\mathrm{RHom}_{kG}^\bullet(\mathrm{R}\Gamma(X(w), k), M) \simeq \mathrm{RHom}_{kG}^\bullet(\mathrm{R}\Gamma(\overline{X}(w), k), M).$$

Let $M_0 = H^{i_0}(kR)$ be the non-zero cohomology group of kR of largest degree. We have $\mathrm{Hom}_{D^b(kG)}(\mathrm{R}\Gamma(\overline{X}(w), k), M_0[-i_0]) \neq 0$. Since $\mathrm{R}\Gamma(X(w), k)$ has a representative with terms in degrees $0, \dots, \ell(w) = 14$, we deduce from the previous isomorphism that $i_0 \leq 14$.

- Step 9: $E_8[\theta]$ and $E_8[\theta^2]$ do not occur as composition factors of the torsion part of $H^*(R)$ and $E_8[\theta^2]$ is a direct summand of $H^{14}(kR)$.

Step 7 shows that $E_8[\theta]$ and $E_8[\theta^2]$ are not composition factors of $H_c^*(X(v), k)$ for $v < w$. It follows that if M is any of the simple modules $E_8[\theta]$ or $E_8[\theta^2]$, then the canonical map $H_c^*(X(w), k) \rightarrow H_c^*(\overline{X}(w), k)$ induces an isomorphism

$$(5.2) \quad \mathrm{Hom}_{kG}(P_M, H_c^i(X(w), k)) \xrightarrow{\sim} \mathrm{Hom}_{kG}(P_M, H_c^i(\overline{X}(w), k)).$$

Since $H_c^i(X(w), k) = 0$ for $i < 14$, we deduce that $E_8[\theta]$ and $E_8[\theta^2]$ do not occur as composition factors of $H_c^i(\overline{X}(w), k)$ for $i < 14$. By Poincaré duality and the

isomorphism (5.2), it follows that $E_8[\theta]$ and $E_8[\theta^2]$ cannot occur as composition factors of $H_c^i(X(w), k)$ for $i > 14$. On the other hand, $E_8[\theta]$ does not occur in $[K\mathrm{R}\Gamma_c(X(w), \mathcal{O})_{(q)}]$ (nor does χ_{exc}), hence $E_8[\theta]$ does not occur as a composition factor of $H_c^{14}(X(w), k)_{(q)}$ or $H_c^{14}(\overline{X}(w), k)_{(q)}$. Similarly, $E_8[\theta^2]$ occurs with multiplicity 1 as a composition factor of $H_c^{14}(X(w), k)_{(q)}$ and of $H_c^{14}(\overline{X}(w), k)_{(q)}$. Proposition 3.5 shows that $E_8[\theta^2]$ is actually a submodule of $H_c^{14}(X(w), k)_{(q)}$ and hence of $H_c^{14}(\overline{X}(w), k)_{(q)}$ by (5.2). Since $KH_c^{14}(\overline{X}(w), K)_{(q)} = E_8[\theta^2]$, it follows that $E_8[\theta^2]$ is a quotient of $H_c^{14}(\overline{X}(w), k)_{(q)}$, hence it is a direct summand.

- Step 10: $(E_8[\theta^2])[-14]$ is a direct summand of kR in $D^b(kG)$.

Let Z be the cone of the canonical map $\mathrm{R}\Gamma_c(X(w), k)_{(q)} \rightarrow \mathrm{R}\Gamma_c(\overline{X}(w), k)_{(q)}$. Step 7 shows that Z can be chosen (up to isomorphism in $D^b(kG)$) to be a bounded complex of projective modules that do not involve edges containing the non-unipotent vertex. The complex kR is quasi-isomorphic to the cone D' of a map $Z[-1] \rightarrow b\mathrm{R}\Gamma_c(X(w), k)_{(q)}$, hence to the truncation $\tau^{\leq 14}(D')$, a complex N with $N^i = 0$ for $i < 0$ and $i > 14$ and with N^i a direct sum of projective modules corresponding to edges that do not contain the non-unipotent vertex for $i \leq 13$. Note that $E_8[\theta]$ and $E_8[\theta^2]$ are not composition factors of N^{13} , hence $E_8[\theta]$ is not a composition factor of N^{14} while $E_8[\theta^2]$ is a composition factor of N^{14} with multiplicity 1 (see Step 9 above). Consider a non-zero morphism $P_{E_8[\theta^2]} \rightarrow N^{14}$ and let U be its image. Since $E_8[\theta^2]$ is a direct summand of $H^{14}(N)$, it follows that the image of U in $H^{14}(N)$ is $E_8[\theta^2]$. On the other hand, the simple modules corresponding to edges containing the non-unipotent vertex but not $E_8[\theta]$ nor $E_8[\theta^2]$ are not quotients of N^{13} , hence $U \simeq E_8[\theta^2]$ embeds in $H^{14}(N)$. It follows that $U[-14]$ is a direct summand of N .

- Step 11: $\mathrm{R}\Gamma_c(\overline{X}(w), \mathcal{O})_{(q-2)} \simeq V[-14]$, where V is an $\mathcal{O}G$ -lattice such that the simple factors of KV are in the D_4 -series.

Let $R' = \mathrm{R}\Gamma_c(\overline{X}(w), \mathcal{O})_{(q-2)}$. We have $KH^i(R') = 0$ for $i \neq 14$ and the simple factors of $KH^{14}(R')$ are in the D_4 -series. As in Step 4, one shows that the torsion of $\mathrm{R}\Gamma_c(\overline{X}(w), \mathcal{O})_{(q-2)}$ is cuspidal. We show as in Steps 5 and 6 that $E_8[-\theta]$ and $E_8[-\theta^2]$ are not composition factors of $H^*(kR')$. Furthermore, $H^{>14}(R') = 0$ as in Step 8. Proceeding as in Step 8, one sees that the canonical map $\mathrm{R}\Gamma_c(X(w), k) \rightarrow \mathrm{R}\Gamma_c(\overline{X}(w), k)$ induces an isomorphism

$$\mathrm{RHom}_{kG}^\bullet(M, \mathrm{R}\Gamma_c(X(w), k)) \simeq \mathrm{RHom}_{kG}^\bullet(M, \mathrm{R}\Gamma_c(\overline{X}(w), k)).$$

Let i_0 be minimal such that $H^{i_0}(kR') \neq 0$, and suppose that $i_0 < 14$. Then $H^{i_0}(kR')$ is cuspidal and

$$\mathrm{Hom}_{D^b(kG)}(H^{i_0}(kR'), \mathrm{R}\Gamma_c(X(w), k)[i_0]) \simeq \mathrm{RHom}_{D^b(kG)}(H^{i_0}(kR'), \mathrm{R}\Gamma_c(\overline{X}(w), k)[i_0]) \neq 0.$$

This contradicts the fact that $\mathrm{R}\Gamma_c(X(w), k)$ has no cohomology in degrees less than 14. Thus, $H^i(kR') = 0$ for $i \neq 14$.

- Step 12: conclusion.

Lemma 3.4 shows that $\mathrm{R}\Gamma_c(X(w), k)_{(q^{-2})} \simeq \mathrm{R}\Gamma_c(X(w), k)_{(q)}[6]$ in kG -stab. By Step 11, we deduce that kV has a direct summand isomorphic to $\Omega^{-6}(E_8[\theta^2])$ in kG -stab. If the Brauer tree is not the one given in Figure 14 (i.e., $E_8[\theta]$ and $E_8[\theta^2]$ need to be swapped), then $\Omega^{-6}(E_8[\theta^2])$ is the reduction of a lattice in $\phi_{300,44}$, which cannot be a direct summand of kV . We deduce that the planar-embedded tree is as shown in Figure 14.

Remark 5.3. We use the determination of the tree to obtain a character-theoretic statement that will be needed in the study of the case $d = 15$.

The Brauer tree of the principal Φ_{18} -block of G is given in [30, Remark 3.11]. In particular, $E_6[\theta^2]_1 \simeq \Omega^{24}k$. Since $\Omega^{24}\phi_{8,1} \simeq E_8[\theta^2]$, we deduce that $\phi_{8,1} \otimes E_6[\theta^2]_1$ is isomorphic to $E_8[\theta^2]$ plus a projective $\mathcal{O}G$ -module P . If $E_8[\theta]$ occurs in the character of P , then the non-unipotent vertex occurs as well. As the degree of the non-unipotent vertex is larger than the degree of $\phi_{8,1} \otimes E_6[\theta^2]_1$, we obtain a contradiction. So, the character of $E_8[\theta]$ is not a constituent of $\phi_{8,1} \otimes E_6[\theta^2]_1$.

5.2.4. $d = 15$. The real stem is known and comprises the principal series characters in the principal ℓ -block. A (Hecke) argument also gives the two subtrees consisting of characters in the $E_6[\theta]$ -series and the $E_6[\theta^2]$ -series as shown in Figure 13.

Except for the two characters $E_8[\theta]$ and $E_8[\theta^2]$, each Harish-Chandra series meeting the principal Φ_{15} -block has a character which appears in the cohomology of the Coxeter variety. The generalized (λ) -eigenspaces on the cohomology of the Coxeter variety are given by

$$\begin{aligned} b\mathrm{H}_c^*(X(c), K)_{(q^8)} &\simeq E_6[\theta]_\varepsilon[-8] \oplus K[-16], \\ b\mathrm{H}_c^*(X(c), K)_{(q^{10})} &\simeq (E_8[\zeta^2])[-8] \oplus E_6[\theta]_1[-10], \\ b\mathrm{H}_c^*(X(c), K)_{(q^7)} &\simeq (E_8[\zeta])[-8] \oplus \phi_{8,1}[-15]. \end{aligned}$$

Corollary 4.23 applied to $\lambda = q^8$ shows that there is an edge between St and $E_6[\theta]_\varepsilon$, and this edge comes between the one containing $\phi_{84,64}$ and St_ℓ in the cyclic ordering of edges around St .

Only cuspidal characters remain to be located, and since they have a larger degree than $E_6[\theta]_1$, we deduce that $E_6[\theta]_1$ remains irreducible modulo ℓ .

From Proposition 4.22 and Theorem 4.21 applied to $C = b\mathrm{R}\Gamma_c(X(c), \mathcal{O})_{(q^{10})}$, we deduce that there is an edge between $E_8[\zeta^2]$ and $E_6[\theta]_\varepsilon$.

Similarly, using $C = b\mathrm{R}\Gamma_c(X(c), \mathcal{O})_{(q^7)}$, we deduce that there is an edge between $\phi_{112,63}$ and $E_8[\zeta]$, and this edge comes between the one containing $\phi_{1400,37}$ and the one containing $\phi_{8,91}$ in the cyclic ordering of edges around $\phi_{112,63}$.

Consequently, the trees in Figures 2 and 3 are subtrees of the Brauer tree T (although as of yet we cannot fix the planar embedding around $E_6[\theta]_\varepsilon$).

We claim that $E_8[\theta]$ and $E_8[\theta^2]$ are not connected to the subtree shown in Figure 2. Let us assume otherwise. By a (Parity) argument, they are not connected to the non-unipotent node. Let $w \in W$ be an element of minimal length such that $E_8[\theta^2]$

appears in the cohomology of $X(w)$ (we have $\ell(w) = 14$). We have

$$[bH_c^*(X(w), K)_{q^2}] = [E_8[\theta^2]] + [\phi_{8,91}] = ([\phi_{8,91}] + [\chi_{\text{exc}}]) - ([\text{St}] + [\chi_{\text{exc}}]) + \eta,$$

where $\eta = [KP]$ and P is a projective $b\mathcal{O}G$ -module whose character does not involve χ_{exc} . Therefore there is an odd integer i such that $\text{Hom}_{D^b(kG)}(\text{R}\Gamma_c(X(w), k), \text{St}_\ell[i]) \neq 0$. Since $i \neq 14$, it follows from Proposition 3.5 that $\langle [H_c^*(X(v), k)], \text{St}_\ell \rangle \neq 0$ for some $v < w$. One easily checks on the character of $H_c^*(X(v), K)$ that this is impossible. As a consequence, $E_8[\theta]$ and $E_8[\theta^2]$ are connected to the subtree shown in Figure 3.

We next return to the planar embedding of the edges around the node $E_6[\theta]_\varepsilon$. If the embedding is not as in Figure 2 then $\Omega^{-13}k$ would lift to an $\mathcal{O}G$ -lattice of character $E_6[\theta^2]_1$, and as $\Omega^{30}k$ lifts to $\phi_{8,1}$, we get that $\Omega^{30}k \otimes \Omega^{-13}k$ lifts to an $\mathcal{O}G$ -lattice with character the sum of the non-unipotent character plus a projective $\mathcal{O}G$ -module. The sum of the degrees of the non-unipotent characters is $(q^6 - 1)(q^8 - 1)(q^{10} - 1)(q^{12} - 1)(q^{14} - 1)(q^{18} - 1)(q^{20} - 1)(q^{24} - 1)\Phi_{30}$. Since this is larger than the degree of $E_6[\theta^2]_1 \otimes \phi_{8,1}$, we deduce that $\Omega^{-13}k$ does not lift to $E_6[\theta^2]_1$, and we obtain the planar-embedded Brauer tree as in Figure 2.

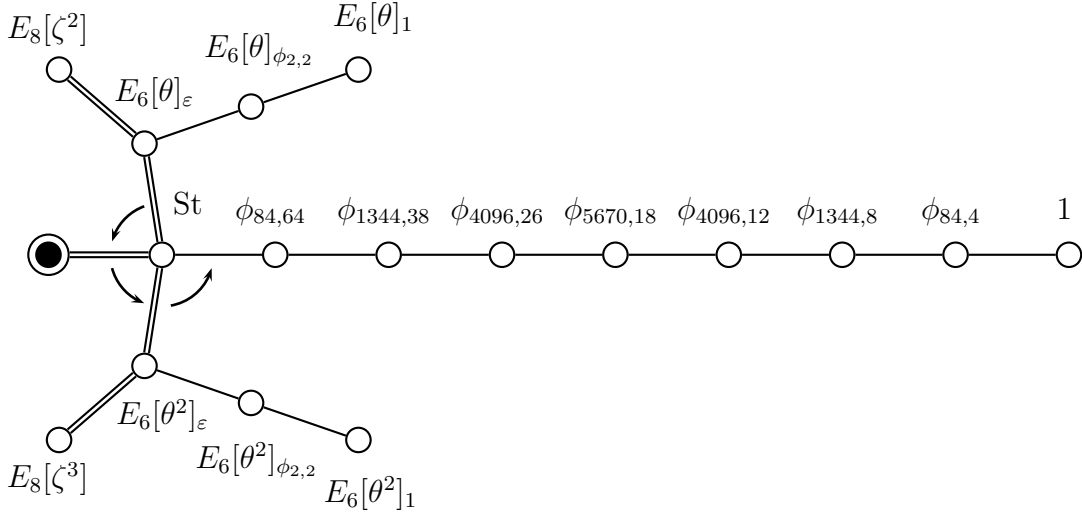

FIGURE 2. Subtree of the principal Φ_{15} -block of $E_8(q)$

It remains to locate $E_8[\theta]$ and $E_8[\theta^2]$. If they were not connected to $\phi_{8,91}$, then $\Omega^{19}k$ would lift to an $\mathcal{O}G$ -lattice of character $\phi_{112,63}$, although $\Omega^{30}k \otimes \Omega^{-11}k$ lifts to a lattice of character $\phi_{8,1} \otimes E_6[\theta^2]_1$ plus a projective module. Since that tensor product has a degree smaller than $\phi_{112,63}$, we obtain a contradiction. Consequently, we obtain the planar-embedded Brauer tree given in Figure 13, up to swapping $E_8[\theta]$ and $E_8[\theta^2]$. Assume the planar embedded tree shown in Figure 13 is not correct. Then $\Omega^{19}k$ lifts to a lattice of character $E_8[\theta]$. Since $\Omega^{30}k \otimes \Omega^{-11}k$ lifts to a lattice of character $\phi_{8,1} \otimes E_6[\theta^2]_1$, we deduce that $E_8[\theta]$ occurs as a constituent of that tensor product, contradicting Remark 5.3. Consequently, the tree in Figure 13 is correct.

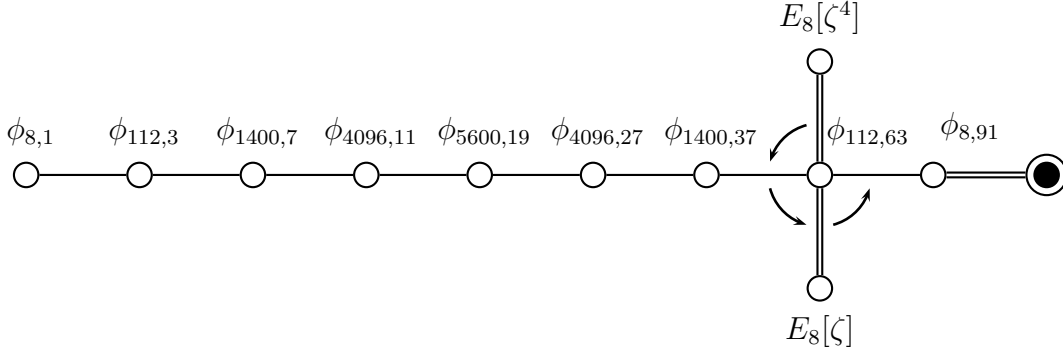

FIGURE 3. Subtree of the principal Φ_{15} -block of $E_8(q)$

5.2.5. $d = 20$. The real stem of the tree is easily determined (see Figure 15). The difficult part is to locate the six cuspidal characters in the block.

We have

$$\begin{aligned} bH_c^*(\overline{X}(c), K)_{(q^8)} &\simeq (E_8[\zeta])[-8] \oplus K[-16], \\ bH_c^*(\overline{X}(c), K)_{(q^{16})} &\simeq (E_8[\zeta^3])[-8] \oplus D_{4,1}[-12]. \end{aligned}$$

Proposition 4.24 and Corollary 4.23 show that there is an edge connecting $E_8[\zeta]$ to St and that this edge comes between the edge containing $\phi_{112,63}$ and the one containing St_ℓ in the cyclic ordering of edges containing St . Also, there is no cuspidal edge connected to a principal series character other than St and we have

$$(5.3) \quad bR\Gamma_c(\overline{X}(c), k)_{(q^8)} \simeq 0 \rightarrow P_{E_8[\zeta]} \rightarrow P_7 \rightarrow \cdots \rightarrow P_0 \rightarrow 0,$$

where P_0 is in degree 16 and P_0, \dots, P_7 are projective indecomposable modules labelling the principal series edges from 1 to St .

Proposition 4.24 and Theorem 4.21 show that there is an edge connecting $E_8[\zeta^3]$ and $D_{4,\varepsilon}$.

We now want to locate the characters $E_8[i]$ and $E_8[-i]$. A (Parity) argument shows that they are not connected to the non-unipotent vertex. The smallest Deligne–Lusztig variety in which they appear is associated to a 24-regular element w of length 10. Note that $\ell \nmid |\mathbf{T}^{vF}|$ for all $v \leq w$. In particular, the character $\eta = [bH_c^*(X(w), K)_{(1)}] = [\text{St}] + [E_8[-i]]$ is virtually projective. It follows from Lemma 4.17 that $\chi_{\text{exc}} + D_{4,\varepsilon}$ does not occur in the decomposition of η in the basis of projective indecomposable modules. As a consequence, $E_8[-i]$ is not connected by an edge to the D_4 -series, hence $E_8[i]$ and $E_8[-i]$ are connected to the Steinberg character.

We are therefore left with determining the planar embedding around $D_{4,\varepsilon}$ and St . Assume that we are in the case shown in Figure 4. Let S_0, \dots, S_4 be the simple modules labelling the edges from $D_{4,1}$ to the non-unipotent node so that

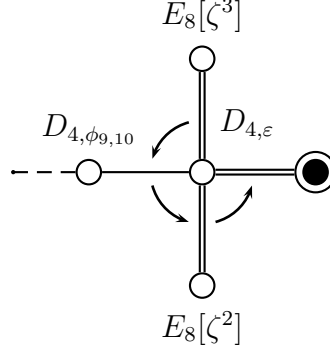

FIGURE 4. Wrong planar embedding for the principal Φ_{20} -block of $E_8(q)$

$[P_{S_4}] = \chi_{\text{exc}} + D_{4,\varepsilon}$. A minimal representative of $b\widetilde{\text{R}}\Gamma_c(\overline{X}(c), k)_{(q^{16})}$ is given by

$$D = 0 \longrightarrow \begin{array}{c} E_8[\zeta^3] \\ S_3 \\ \boxed{E_8[\zeta^2]} \\ S_4 \\ E_8[\zeta^3] \end{array} \longrightarrow \begin{array}{c} S_3 \\ \boxed{E_8[\zeta^2]} \\ S_4 \\ E_8[\zeta^3] \\ S_3 \end{array} \xrightarrow{S_2} \begin{array}{cc} S_2 & S_1 \\ S_3 & S_2 \end{array} \longrightarrow \begin{array}{cc} S_1 & S_0 \\ S_2 & S_1 \end{array} \longrightarrow \begin{array}{c} \boxed{S_0} \\ S_1 \\ S_0 \end{array} \longrightarrow 0,$$

where the cohomology groups (represented by the boxes) are non-zero in degrees 8, 9 and 12 only. A non-zero map $P_{E_8[\zeta^2]} \rightarrow P_{E_8[\zeta^3]}$ gives a non-zero element of $\text{Hom}_{D^b(kG)}(D^*[-16], D)$. Consequently, $H^{16}(D \otimes_{kG} D) \neq 0$. We have

$$b\text{R}\Gamma_c(\overline{X}(c), K)_{(q^{16})} \otimes_{KG} b\text{R}\Gamma_c(\overline{X}(c), K)_{(q^{16})} \simeq K[-24],$$

and Proposition 3.7 shows that the cohomology of $b\text{R}\Gamma_c(\overline{X}(c), \mathcal{O})_{(q^{16})} \otimes_{\mathcal{O}G} b\text{R}\Gamma_c(\overline{X}(c), \mathcal{O})_{(q^{16})}$ is torsion-free, hence $H^i(b\text{R}\Gamma_c(\overline{X}(c), k)_{(q^{16})} \otimes_{kG} b\text{R}\Gamma_c(\overline{X}(c), k)_{(q^{16})}) = 0$ for $i \neq 24$: this gives a contradiction.

We now turn to the four possibilities for the planar embedding around the node labelled by the Steinberg character. We need to rule out the three of them shown in Figure 5. Recall that w denotes a 24-regular element. As in the case of $\overline{X}(c)$,

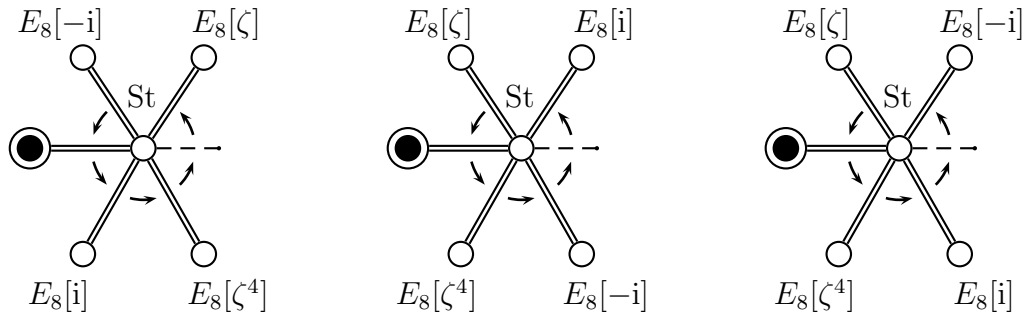

FIGURE 5. Wrong planar embeddings for the principal Φ_{20} -block of $E_8(q)$

Proposition 3.8 ensures that the torsion part in the cohomology of $b\mathrm{R}\Gamma_c(\overline{X}(w), \mathcal{O})$ is cuspidal. Let $C = (b\widetilde{\mathrm{R}}\Gamma_c(\overline{X}(w), \mathcal{O})_{(q^{10})})^{\mathrm{red}}$, a complex with 0 terms in degrees less than 0 and greater than 20. We have

$$KC \simeq E_8[i][-10] \oplus K[-20].$$

We will describe completely the complex C , and rule out the wrong planar embeddings. We will proceed in a number of steps.

- Step 1: the only non-cuspidal simple module that can appear as a composition factor of $H^*(kC)$ is K , and it can only appear in $H^{20}(kC)$. The simple modules St_ℓ , $E_8[\zeta^2]$ and $E_8[\zeta^3]$ do not occur as composition factors of $H^*(kC)$.

The first statement follows from the discussion above. As a consequence, we have $P_{S_i} \otimes_{kG} kC \simeq 0$ for $i = 0, \dots, 3$ and therefore

$$P_{E_8[\zeta^3]}[-8] \otimes_{kG} kC \simeq b\mathrm{R}\Gamma_c(\overline{X}(c), k)_{(q^{16})} \otimes_{kG} kC.$$

The latter is a direct summand of $\mathrm{R}\Gamma_c(\overline{X}(c) \times_G \overline{X}(w))$, which by Proposition 3.7 has no torsion in its cohomology. We deduce that $P_{E_8[\zeta^3]} \otimes_{kG} kC$ is quasi-isomorphic to zero, which means that $E_8[\zeta^2]$ does not occur as a composition factor in $H^*(kC)$. The same result can be shown to hold for $E_8[\zeta^3]$, by replacing $b\mathrm{R}\Gamma_c(\overline{X}(c), k)_{(q^{16})}$ by $(b\mathrm{R}\Gamma_c(\overline{X}(c), k)_{(q^{16})})^*[-16] \simeq b\mathrm{R}\Gamma_c(\overline{X}(c), k)_{(q^4)}$. The statement about St_ℓ follows from Proposition 3.11.

- Step 2: $E_8[\zeta^4]$ does not occur as a composition factor of $H^*(kC)$ and $E_8[\zeta]$ does not occur as a composition factor of $H^i(kC)$ for $i \notin \{12, 13\}$.

We have $b\mathrm{R}\Gamma_c(\overline{X}(c), k)_{(1)} \otimes_{kG} kC \simeq k[-20]$ and $\mathrm{R}\Gamma_c(\overline{X}(c), k)_{(q^8)} \otimes_{kG} kC \simeq k[-36]$. Moreover, $P_i \otimes_{kG} kC \simeq 0$ for $i = 1, \dots, 7$ but $P_0 \otimes_{kG} kC \simeq k[-20]$, so we obtain from (5.3) a distinguished triangle

$$P_{E_8[\zeta]}[-9] \otimes_{kG} kC \rightarrow k[-36] \rightarrow k[-36] \rightsquigarrow$$

Using $\mathrm{R}\Gamma_c(\overline{X}(c), k)_{(q^{12})} \simeq (\mathrm{R}\Gamma_c(\overline{X}(c), k)_{(q^8)})^*[-16]$ instead of $\mathrm{R}\Gamma_c(\overline{X}(c), k)_{(q^8)}$, we obtain a distinguished triangle

$$k[-20] \rightarrow k[-20] \rightarrow P_{E_8[\zeta^4]}[-7] \otimes_{kG} kC \rightsquigarrow$$

The variety $\overline{X}(w)$ has dimension 10, and therefore its cohomology vanishes outside the degrees $0, \dots, 20$. Therefore $P_{E_8[\zeta]} \otimes_{kG} kC \simeq 0$. We also deduce that $P_{E_8[\zeta^4]} \otimes_{kG} kC$ is quasi-isomorphic to either 0 or $k[-12] \oplus k[-13]$.

- Step 3: P_{S_4} , P_{St_ℓ} and $P_{E_8[-i]}$ do not occur in C , while $P_{E_8[i]}$ occurs with multiplicity 1 in C (and this is in C^{10}).

The statements about $P_{E_8[\pm i]}$ are clear using Proposition 3.5, while the other two statements follow from Lemma 4.17.

We have now enough information to determine C and rule out the planar embeddings given in Figure 5.

- Step 4: $C^i = 0$ for $i < 10$.

Let i be the smallest degree for which $H^i(C)$ has non-zero torsion. Assume that $i \leq 10$. The cohomology $H^{i-1}(kC)$ is cuspidal with socle in $\{S_4, E_8[i], E_8[-i]\}$. On the other hand, $kC^{<(i-1)} = 0$ and the injective hulls of S_4 and $E_8[\pm i]$ do not occur as direct summands of kC^{i-1} , a contradiction. It follows that $H^i(C) = 0$ for $i < 10$ and $H^{10}(C)$ is torsion-free. So, $H^i(kC) = 0$ for $i < 10$, hence $(kC)^i = 0$ for $i < 10$.

- Step 5: We have $H^i(C) = 0$ for $14 \leq i \leq 19$ and $H^{20}(C) = \mathcal{O}$.

Lemma 4.20 applied to the stupid truncation $C^{13} \rightarrow C^{14} \rightarrow \dots \rightarrow C^{20}$ (viewed in degrees $-7, \dots, 0$) shows that

$$C \simeq 0 \rightarrow C^{10} \rightarrow C^{11} \rightarrow C^{12} \rightarrow C^{13} \rightarrow P_6 \rightarrow P_5 \rightarrow \dots \rightarrow P_1 \rightarrow P_0 \rightarrow 0,$$

$H^i(C) = 0$ for $14 \leq i \leq 19$ and $H^{20}(C) = \mathcal{O}$.

- Step 6: $H^{10}(kC) = E_8[i]$ and $H^{11}(C) = 0$.

By the universal coefficient theorem $H^{10}(kC)$ is an extension of $L = \text{Tor}_1^{\mathcal{O}}(H^{11}(C), k)$ by $kH^{10}(C) = E_8[i]$. Since $\text{Ext}^1(M, E_8[i]) = 0$ for all kG -modules M with composition factors in $\{S_4, E_8[i], E_8[-i]\}$, it follows that the kG -module L is a direct summand of $H^{10}(kC)$, hence C^{10} has an injective hull of L as a direct summand of kC^{10} . This shows that $C^{10} = P_{E_8[i]}$ and $L = 0$.

- Step 7: $\text{Ext}^1(\text{St}_\ell, E_8[i]) = 0$.

The differential $C^{10} \rightarrow C^{11}$ induces an injective map $\Omega^{-1}E_8[i] \hookrightarrow C^{11}$. Since P_{St_ℓ} is not a direct summand of C^{11} , it follows that St_ℓ does not occur in the socle of C^{11} , hence not in the socle of $\Omega^{-1}E_8[i]$.

This rules out the first possibility of the planar embedding around St in Figure 5.

- Step 8: $H^{12}(C) = 0$.

Let $L = \text{Tor}_1^{\mathcal{O}}(H^{12}(C), k)$. The kG -module $\Omega^{-2}E_8[i]$ has no composition factors isomorphic to S_4 , $E_8[i]$ or $E_8[-i]$, hence $\text{Hom}(L, \Omega^{-2}E_8[i]) = 0$. It follows that $\text{Ext}^1(L, \Omega^{-1}E_8[i]) = 0$, hence an injective hull of L is a direct summand of kC^{11} , which forces $L = 0$, hence $H^{12}(C) = 0$.

- Step 9: $C^{13} \simeq P_7$.

We have $C^{13} \simeq P_7 \oplus R$ for some projective kG -module R , whose head is in $H^{13}(kC)$. It follows from Steps 1-3 that $R \simeq P_{E_8[\zeta]}^{\oplus n}$ for some $n \geq 0$. Assume that $n > 0$. Since St_ℓ does not occur as a composition factor of $H^{13}(kC)$, it follows that $E_8[\varepsilon i]$ must occur immediately after $E_8[\zeta]$ in the cyclic ordering around St for some $\varepsilon \in \{+, -\}$ and $P_{E_8[\varepsilon i]}$ occurs as a direct summand of C^{12} : this is a contradiction. We deduce that $C^{13} \simeq P_7$.

- Step 10: conclusion.

Assume that the configuration around St is the second one in Figure 5. Then $\Omega^{-3}E_8[i]$ is an extension of S_6 by S_5 . Since S_5 does not occur as a composition factor of $H^{12}(kC)$, it follows that P_5 is a direct summand of C^{13} , a contradiction. Assume now the configuration is the third one in Figure 5. The socle of $\Omega^{-3}E_8[i]$ is St_ℓ . Since St_ℓ does not occur as a composition factor of $H^{12}(kC)$ and a projective

cover does not occur as a direct summand of C^{13} , we obtain a contradiction. This concludes the determination of the Brauer tree. Note that now $\Omega^{-2}E_8[i] = E_8[\zeta]$, $C^{12} \simeq P_{E_8[\zeta]}$ and $H^{12}(kC) = 0$. In particular, $H^*(C)$ is torsion-free and C is

$$0 \rightarrow P_{E_8[i]} \rightarrow P_{E_8[\zeta]} \rightarrow P_{E_8[\zeta]} \rightarrow P_7 \rightarrow P_6 \rightarrow \cdots \rightarrow P_0 \rightarrow 0.$$

5.2.6. $d = 24$. Several Harish-Chandra series lie in the principal Φ_d -block, and a (Hecke) argument gives the corresponding subtrees, as well as the real stem, as shown in Figure 16.

- Step 1: cuspidal modules $E_8[-\theta]$ and $E_8[-\theta^2]$.

The two cuspidal characters $E_8[-\theta]$ and $E_8[-\theta^2]$ appear in the cohomology of a Coxeter variety $X(c)$. To locate them on the Brauer tree we shall look at the cohomology of a compactification $\bar{X}(c)$ and proceed as in the beginning of §5.2.5. We have

$$bR\Gamma_c(\bar{X}(c), K)_{(q^8)} \simeq (E_8[-\theta^2])[-8] \oplus K[-16].$$

we deduce from Corollary 4.23 and Theorem 4.21 (see Proposition 4.24) that

$$(5.4) \quad bR\Gamma_c(\bar{X}(c), \mathcal{O})_{(q^8)} \simeq 0 \rightarrow P_{E_8[-\theta^2]} \rightarrow P_7 \rightarrow \cdots \rightarrow P_0 \rightarrow 0,$$

where P_1, \dots, P_7 is the unique path of projective covers of non-cuspidal simple modules corresponding to edges from k to St in the Brauer tree, and the tree in Figure 6 is a subtree of T . Furthermore, the only principal series vertex connected by an edge to a non-principal series vertex is St .

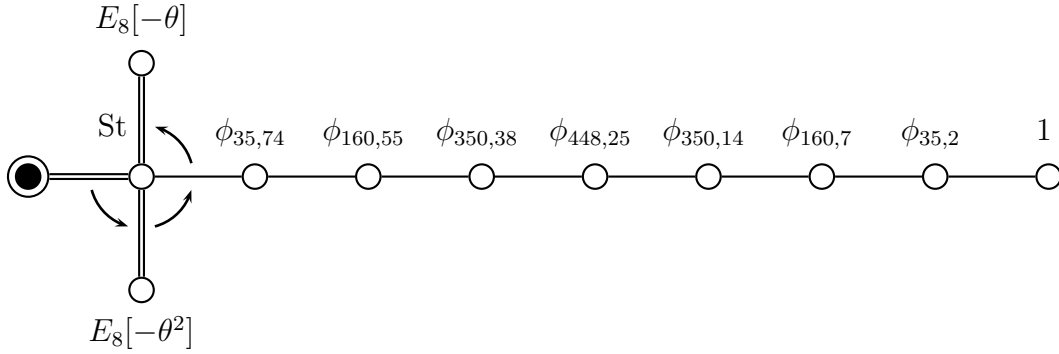

FIGURE 6. Subtree of the principal Φ_{24} -block of $E_8(q)$

- Step 2: E_6 -series.

We now locate the E_6 -series characters. By a (Degree) argument, $E_6[\theta]_{\phi''_{1,3}}$ and $E_6[\theta^2]_{\phi''_{1,3}}$ are not leaves in the tree, so, by a (Parity) argument, must be connected to one of the non-unipotent vertex, $D_{4,\phi''_{8,9}}$ or $D_{4,\phi''_{8,3}}$, and they are connected to the same node. Note that $E_6[\theta^{\pm 1}]_{\phi''_{1,3}}$ is connected to exactly two characters: $E_6[\theta^{\pm 1}]_{\phi_{2,2}}$ and the real character above (by a (Parity) argument, it cannot be connected to $E_8[\pm i]$). For all q , the degree of

$$[D_{4,\phi''_{8,9}}] - ([E_6[\theta]_{\phi''_{1,3}}] - [E_6[\theta]_{\phi_{2,2}}] + [E_6[\theta^2]_{\phi''_{1,3}}] - [E_6[\theta^2]_{\phi_{2,2}}])$$

is negative, hence it cannot be the class of a kG -module. As a consequence, $E_6[\theta^{\pm 1}]_{\phi'_{1,3}}$ is not connected to $D_{4,\phi''_{8,9}}$. The same statement holds for $D_{4,\phi'_{8,3}}$, hence $E_6[\theta^{\pm 1}]_{\phi'_{1,3}}$ is connected to the non-unipotent node.

Again, (Parity) and (Degree) arguments show that the characters $E_8[\pm i]$ are connected to the non-unipotent node, or one of the nodes $D_{4,\phi''_{8,9}}$, $E_6[\theta]_{\phi_{2,2}}$ or $E_6[\theta^2]_{\phi_{2,2}}$. Note that, from the subtree constructed so far and that $E_8[\pm i]$ and $E_6[\theta^{\pm 1}]_{\phi'_{1,3}}$ have the same parity, they must both be leaves in the tree and so remain irreducible modulo ℓ .

Let $w \in W$ be a regular element of order 24 and length 10. We have

$$b\mathrm{R}\Gamma_c(\overline{X}(w), K)_{(q^{11})} \simeq E_8[i][-10],$$

$$b\mathrm{R}\Gamma_c(\overline{X}(w), K)_{(q^{14})} \simeq E_6[\theta]_{\phi'_{1,3}}[-12].$$

- Step 3: $E_8[-\theta]$ and $E_8[-\theta^2]$ do not occur in $H_c^*(\overline{X}(w), k)_{(\lambda)}$.

Let λ be either q^{11} or q^{14} . The torsion part in $b\mathrm{R}\Gamma_c(\overline{X}(w), \mathcal{O})_{(\lambda)}$ is cuspidal by Proposition 3.8. Since its character has no composition factor in the principal series we have $\mathrm{R}\Gamma_c(\overline{X}(w), k)_{(\lambda)} \otimes_{kG} P_i = 0$ for $i \in \{0, \dots, 7\}$. Using Proposition 3.7 for the variety $\overline{X}(w) \times_G \overline{X}(c)$ together with (5.4) and the dual description of $b\mathrm{R}\Gamma_c(\overline{X}(c), \mathcal{O})_{(1)}$, we deduce that $\mathrm{R}\Gamma_c(\overline{X}(w), k)_{(\lambda)} \otimes_{kG} P_{E_8[-\theta]} = \mathrm{R}\Gamma_c(\overline{X}(w), k)_{(\lambda)} \otimes_{kG} P_{E_8[-\theta^2]} = 0$. This ensures that neither $E_8[-\theta]$ nor $E_8[-\theta^2]$ can occur as composition factors of the cohomology of $b\mathrm{R}\Gamma_c(\overline{X}(w), k)_{(\lambda)}$.

- Step 4: $b\mathrm{R}\Gamma_c(\overline{X}(w), k)_{(q^{11})}$ and position of $E_8[\pm i]$.

Let $C = b\mathrm{R}\Gamma_c(\overline{X}(w), k)_{(q^{11})}$ and let $M = H^i(C)$ be the non-zero cohomology group with largest degree. Suppose that $i > 10$. The module M is cuspidal and its composition factors are cuspidal modules different from $E_8[-\theta]$ and $E_8[-\theta^2]$. Proposition 3.5 shows that $\mathrm{RHom}_{kG}^\bullet(\mathrm{R}\Gamma_c(X(v), k), M) = 0$ for all $v < w$. By the construction of the smooth compactifications, we obtain an isomorphism

$$\mathrm{RHom}_{kG}^\bullet(\mathrm{R}\Gamma(X(w), k), M) \xrightarrow{\sim} \mathrm{RHom}_{kG}^\bullet(\mathrm{R}\Gamma_c(\overline{X}(w), k), M).$$

Since $\mathrm{R}\Gamma(X(w), k)$ has a representative with terms in degrees $0, \dots, \ell(w) = 10$, we deduce that $\mathrm{Hom}_{D^b(kG)}(\mathrm{R}\Gamma_c(\overline{X}(w), k), M[-i]) = 0$, which is impossible since C is a direct summand of $\mathrm{R}\Gamma_c(\overline{X}(w), k)$ and the map $C \rightarrow M[-i] = H^i(C)[-i]$ is non-zero. This shows that $H^j(C) = 0$ for $j > 10$. Using the same argument with the isomorphism

$$\mathrm{RHom}_{kG}^\bullet(M, \mathrm{R}\Gamma_c(X(w), k)) \xrightarrow{\sim} \mathrm{RHom}_{kG}^\bullet(M, \mathrm{R}\Gamma_c(\overline{X}(w), k))$$

and the fact that $\mathrm{R}\Gamma_c(X(w), k)$ has a representative with terms in degrees $10 = \ell(w), \dots, 2\ell(w) = 20$, we deduce that $H^j(C) = 0$ for $j < 10$. Therefore $C \simeq H^{10}(C)[-10]$.

Now, Proposition 4.18 and Remark 4.19 show that $E_8[i] \simeq \Omega^{12}k$. We deduce that $E_8[\pm i]$ are connected to the non-unipotent node and this gives the whole tree as shown in Figure 16, up to swapping the $E_6[\theta]$ and the $E_6[\theta^2]$ -series.

- Step 5: $b\mathrm{R}\Gamma_c(\overline{X}(w), k)_{(q^{14})}$ and conclusion.

The previous argument applied to the complex $D = b\mathrm{R}\Gamma_c(\overline{X}(w), k)_{(q^{14})}$ shows that the cohomology of D vanishes outside the degrees 10, 11 and 12, and that $H^{12}(D)$ is a module with simple head isomorphic to $E_6[\theta]_{\phi'_{1,3}}$. The radical of $H^{12}(D)$ is cuspidal. Since $E_6[\theta]_{\phi'_{1,3}}$ has no non-trivial extensions with simple cuspidal modules, we deduce that $H^{12}(D) = E_6[\theta]_{\phi'_{1,3}}$ and $H_c^{12}(\overline{X}(w), \mathcal{O})_{(q^{14})}$ is torsion-free.

Let us denote the simple modules in the $E_6[\theta]$ -series as in Figure 7. There exists

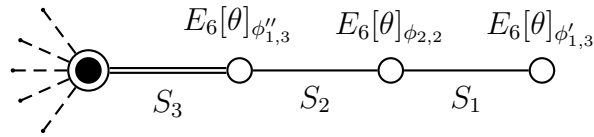

FIGURE 7. Subtree of the principal Φ_{24} -block of $E_8(q)$

a representative of D of the form

$$D = 0 \rightarrow X \rightarrow P' \oplus P_{S_2} \rightarrow P_{S_1} \rightarrow 0,$$

where P' is a projective module with no cuspidal simple quotient except possibly $E_8[-\theta]$ or $E_8[-\theta^2]$ (by Proposition 3.5). Since $H^{11}(D)$ is a cuspidal module with no composition factor isomorphic to $E_8[-\theta]$ or $E_8[-\theta^2]$, we deduce that the representative of D can be chosen so that $P' = 0$. By the universal coefficient theorem, we have $H^{10}(D) \simeq H^{11}(D)$. We have $H^{11}(D) = 0$ or $H^{11}(D) = S_3$. In both cases, we find that X is a module with composition factors S_2 and S_3 .

Proposition 4.18 and Remark 4.19 show that $X \simeq \Omega^{18}k$ in kG -stab. We deduce that $\Omega^{18}k$ lifts to an $\mathcal{O}G$ -lattice of character $E_6[\theta]_{\phi'_{1,3}}$, which gives the planar embedding.

5.3. Other exceptional groups. The Brauer trees of unipotent blocks for exceptional groups other than $E_7(q)$ and $E_8(q)$ were determined in [13, 64, 47, 38, 48, 49] (under an assumption on q for one of the blocks in ${}^2E_6(q)$), but only up to choice of field of values in each block. This ambiguity can be removed using Lusztig's parametrization of unipotent characters. We achieve this by choosing carefully the roots of unity in $\overline{\mathbb{Q}}_\ell$ associated with the cuspidal characters, as we did in the previous sections.

5.3.1. $E_6(q)$, ${}^2E_6(q)$, $F_4(q)$ and $G_2(q)$. For each of the exceptional groups of type $E_6(q)$, ${}^2E_6(q)$, $F_4(q)$ and $G_2(q)$ there are only two blocks with cyclic defect groups whose Brauer trees are not lines. One of the blocks corresponds to the principal

Φ_h -block with h the Coxeter number, and this case was solved in [29]. For the other one, one proceeds exactly as in §5.1.1, where only a pair of conjugate cuspidal characters lies outside the real stem (these characters appear in the cohomology of a Coxeter variety). The planar-embedded Brauer trees can be found in [19].

5.3.2. ${}^2B_2(q^2)$ and ${}^2G_2(q^2)$. For the Suzuki groups ${}^2B_2(q^2)$ and the Ree groups ${}^2G_2(q^2)$, the Frobenius eigenvalue corresponding to each unipotent character is known by [12]. It is enough to locate a single non-real character to fix the planar embedding. One can take this character to be a non-real cuspidal character occurring in the cohomology of the Coxeter variety and proceed as before to get the trees given in [19]. Note that for these groups the Coxeter variety is 1-dimensional, therefore its cohomology is torsion-free and $\Omega^2 k$ is isomorphic in kG -stab to the generalized (q^2) -eigenspace of F^2 in $\mathrm{R}\Gamma_c(\mathrm{X}(c), k)$ (when d is not the Coxeter number).

5.3.3. ${}^2F_4(q^2)$. We now consider the Ree groups ${}^2F_4(q^2)$, whose Brauer trees have been determined in [47] using the parametrization given in [59], but not using Lusztig's parametrization.

Here, there are three trees that are not lines. One of them corresponds to the case solved in [29], and another one is similar to §5.1.1. The only block which deserves a specific treatment is the principal ℓ -block with $\ell \mid (q^4 + \sqrt{2}q^3 + q^2 + \sqrt{2}q + 1)$ (so, q is a 24-th root of unity modulo ℓ). Let η , i and θ be the roots of unity in \mathcal{O} having the same image as respectively q^{15} , q^6 and q^{16} in the residue field k .

A (Hecke) argument gives the real stem of the Brauer tree as shown in Figure 8 as well as the two edges for the 2B_2 -series.

We consider the two generalized ‘mod- ℓ -eigenspaces’ of F^2 on the cohomology of the Coxeter variety given by

$$\begin{aligned} \mathrm{R}\Gamma_c(\mathrm{X}(c), K)_{(q^{-2})} &= ({}^2B_2[\eta^3]_\varepsilon \oplus {}^2F_4[-\theta^2])[-2], \\ \mathrm{R}\Gamma_c(\mathrm{X}(c), K)_{(q^4)} &= {}^2B_2[\eta^5]_\varepsilon[-2] \oplus K[-4]. \end{aligned}$$

Lemma 3.14 and Proposition 3.15 show that ${}^2B_2[\eta^3]_\varepsilon + {}^2F_4[-\theta^2]$ is the character of a projective module $P_{2F_4[-\theta^2]}$, hence ${}^2B_2[\eta^3]_\varepsilon$ and ${}^2F_4[-\theta^2]$ are connected by an edge. Furthermore, $\mathrm{R}\Gamma_c(\mathrm{X}(c), \mathcal{O})_{(q^{-2})} \simeq P_{2F_4[-\theta^2]}[-2]$.

Corollary 4.23 show that there is no non-real vertex connected to 1 or $\phi_{2,3}$, that there is an edge $S[\eta^5]$ connecting St and ${}^2B_2[\eta^5]_\varepsilon$, and, in the cyclic ordering of edges containing St , the edge $S[\eta^5]$ comes after the one containing $\phi_{2,3}$ and before St_ℓ . Furthermore,

$$\mathrm{R}\Gamma_c(\mathrm{X}(c), \mathcal{O})_{(q^{-2})} \simeq 0 \rightarrow P_{S[\eta^5]} \rightarrow P_1 \rightarrow P_k \rightarrow 0,$$

where P_k is in degree 4 and P_1 is projective with character $\phi_{2,3} + \mathrm{St}$.

We can now deduce the corresponding complexes of cohomology for $\overline{\mathrm{X}}(c)$. For $\lambda \in \{q^{-2}, q^4\}$ and I an F -stable proper subset of S , we have $b\mathrm{R}\Gamma_c(\mathrm{X}(c_I), \mathcal{O})_{(\lambda)} = 0$

unless (L_i, F) has type 2B_2 , in which case the complex has cohomology concentrated in degree 1. In addition, using duality for the case $\lambda \in \{q^6, 1\}$, we find

$$\begin{aligned} b\mathrm{R}\Gamma_c(\overline{X}(c), \mathcal{O})_{(q^{-2})} &\simeq 0 \rightarrow 0 \rightarrow P_{2B_2[\eta^3]_1} \rightarrow P_{2F_4[-\theta^2]} \rightarrow 0 \rightarrow 0 \rightarrow 0, \\ b\mathrm{R}\Gamma_c(\overline{X}(c), \mathcal{O})_{(q^6)} &\simeq 0 \rightarrow 0 \rightarrow 0 \rightarrow P_{2F_4[-\theta]} \rightarrow P_{2B_2[\eta^5]_1} \rightarrow 0 \rightarrow 0, \\ b\mathrm{R}\Gamma_c(\overline{X}(c), \mathcal{O})_{(q^4)} &\simeq 0 \rightarrow 0 \rightarrow P_{2B_2[\eta^5]_1} \rightarrow P_{S[\eta^5]} \rightarrow P_1 \rightarrow P_k \rightarrow 0, \\ b\mathrm{R}\Gamma_c(\overline{X}(c), \mathcal{O})_{(1)} &\simeq 0 \rightarrow P_k \rightarrow P_1 \rightarrow P_{S[\eta^3]} \rightarrow P_{2B_2[\eta^3]_1} \rightarrow 0 \rightarrow 0, \end{aligned}$$

where $S[\eta^3]$ is the edge connecting St and ${}^2B_2[\eta^3]_\varepsilon$. Since $\mathrm{R}\Gamma_c(\overline{X}(c) \times_G \overline{X}(c), \mathcal{O})$ is torsion-free (Proposition 3.7), we deduce that the differentials between non-zero terms of the complexes above cannot be zero. This determines uniquely the four complexes above up to isomorphism.

We have

$$\begin{aligned} &b\mathrm{R}\Gamma_c(\overline{X}(c), \mathcal{O})_{(q^{-2})} \otimes_{\mathcal{O}_G} b\mathrm{R}\Gamma_c(\overline{X}(c), \mathcal{O})_{(q^4)} \simeq \\ &\mathrm{Hom}_{kG}^\bullet(0 \rightarrow P_{S[\eta^3]} \rightarrow P_{2B_2[\eta^3]_1} \rightarrow 0, 0 \rightarrow P_{2B_2[\eta^3]_1} \rightarrow P_{2F_4[-\theta^2]} \rightarrow 0)[-3]. \end{aligned}$$

By Proposition 3.7, this complex D has homology \mathcal{O} concentrated in degree 2. Assume that, in the cyclic ordering of edges containing ${}^2B_2[\eta^3]_\varepsilon$, the edge containing ${}^2F_4[-\theta^2]$ comes after the edge containing ${}^2B_2[\eta^3]_1$ but before the edge containing St . Then a non-zero map $kP_{S[\eta^3]} \rightarrow kP_{F_4[-\theta^2]}$ does not factor through $kP_{2B_2[\eta^3]_1}$: so, it gives rise to a non-zero element of $H^4(kD)$, a contradiction. It follows that the subtree obtained by removing ${}^2F_4[\pm i]$ is given by Figure 8.

Let $w \in W$ of length 6 such that wF has order 8 and let $C = b\mathrm{R}\Gamma_c(\overline{X}(w), \mathcal{O})_{(-1)}$. There are 12 such elements and they are all F -conjugate. The complex C is a perfect complex; the torsion part of its cohomology is cuspidal by Proposition 3.8 and it does not involve St_ℓ by Proposition 3.11. In addition, there is a representative of C that involves neither $P_{2F_4^{\mathrm{IV}}[-1]}$ nor P_{St_ℓ} by Lemma 4.17. It follows that ${}^2F_4^{\mathrm{IV}}[-1]$ does not occur as a composition factor of the cohomology of kC . Therefore the possible composition factors in the torsion part of $H^*(C)$ are the cuspidal simple modules ${}^2F_4[\pm i]$, ${}^2F_4[-\theta^j]$ and $S[\eta^m]$.

The cohomology of KC is given by

$$KC \simeq (F_4[i])[-6] \oplus F_4[-\theta]^{\oplus 3}[-8] \oplus {}^2B_2[\eta^5]_1^{\oplus 5}[-9] \oplus K[-12].$$

Using Proposition 3.7 one can easily compute $kC \otimes_{kG}^{\mathbb{L}} b\mathrm{R}\Gamma_c(\overline{X}(c), k)_{(\lambda)}$ for the various eigenvalues λ of F^2 . With the same method as in Steps 1 and 2 of §5.2.5, the cases $\lambda = q^{-2}, q^6, q^4, 1$ show that

- ${}^2F_4[-\theta]$ can occur as a composition factor of $H^*(kC)$ only in degrees 8 or 9, because $\mathrm{Hom}_{D^b(kG)}(P_{2B_2[\eta^5]_1}, kC[i]) = 0$ for $i \neq 9$;
- ${}^2F_4[-\theta^2]$ does not occur as a composition factor of $H^*(kC)$ because $\mathrm{Hom}_{D^b(kG)}(P_{2B_2[\eta^3]_1}, kC[i]) = 0$ for all i ;

- $S[\eta^3]$ does not occur as a composition factor of $H^*(kC)$ because $\text{Hom}_{D^b(kG)}(P_{2B_2[\eta^3]_1}, kC[i]) = \text{Hom}_{D^b(kG)}(P_1, kC[i]) = 0$ for all i ;
- $S[\eta^5]$ can occur as a composition factor of $H^*(kC)$ only in degrees 9, 10 and 11 because $\text{Hom}_{D^b(kG)}(P_1, kC[i]) = 0$ for all i and $\text{Hom}_{D^b(kG)}(P_{2B_2[\eta^5]_1}, kC[i]) = 0$ for $i \neq 9$.

There are five distinct possible planar trees other than the one in Figure 8. One checks that for each of those five bad embeddings,

- $\Omega^{-3}({}^2F_4[i])$ and $\Omega^{-4}({}^2F_4[i])$ do not contain ${}^2F_4[-\theta]$ as a submodule,
- $\Omega^{-4}({}^2F_4[i])$ does not contain ${}^2B_2[\eta^5]_1$ as a submodule,
- $\Omega^{-4}({}^2F_4[i])$, $\Omega^{-5}({}^2F_4[i])$ and $\Omega^{-6}({}^2F_4[i])$ do not contain $S[\eta^5]$ as a submodule,
- $\Omega^{-7}({}^2F_4[i])$ does not contain k as a submodule, or
- $\Omega^{-j}({}^2F_4[i])$ does not contain ${}^2F_4[i]$ nor ${}^2F_4[-i]$ as a submodule for $1 \leq j \leq 6$.

Since $kH^6(C) \simeq {}^2F_4[i]$, it follows that $\text{Ext}_{kG}^{j+1}(H^{6+j}(kC), kH^6(C)) = 0$ for $j \geq 1$ and $\text{Ext}_{kG}^1(\text{Tor}_1^{\mathcal{O}}(k, H^7(C)), kH^6(C)) = 0$. Let D be the cone of the canonical map $kH^6(C) \rightarrow kC[6]$. We have $\text{Hom}_{D^b(kG)}(D, kH^6(C)[1]) = 0$, hence $kH^6(C)$ is isomorphic to a direct summand of C . Since C is perfect and ${}^2F_4[i]$ is not projective, we have a contradiction. This proves that the tree in Figure 8 is correct.

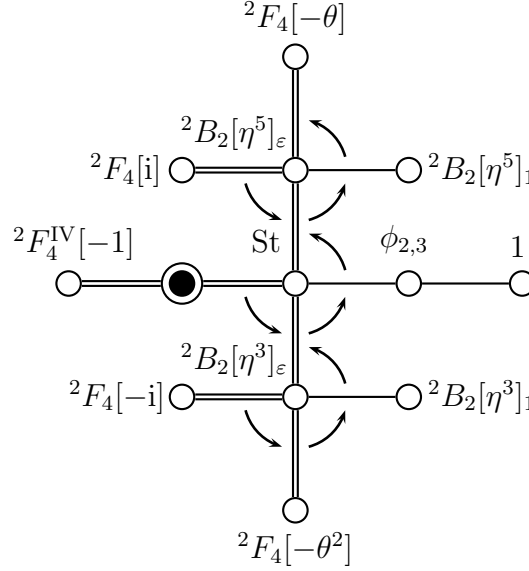

FIGURE 8. Principal ℓ -block of ${}^2F_4(q^2)$ with $\ell \mid q^4 + \sqrt{2}q^3 + q^2 + \sqrt{2}q + 1$

APPENDIX A. BRAUER TREES FOR $E_7(q)$ AND $E_8(q)$

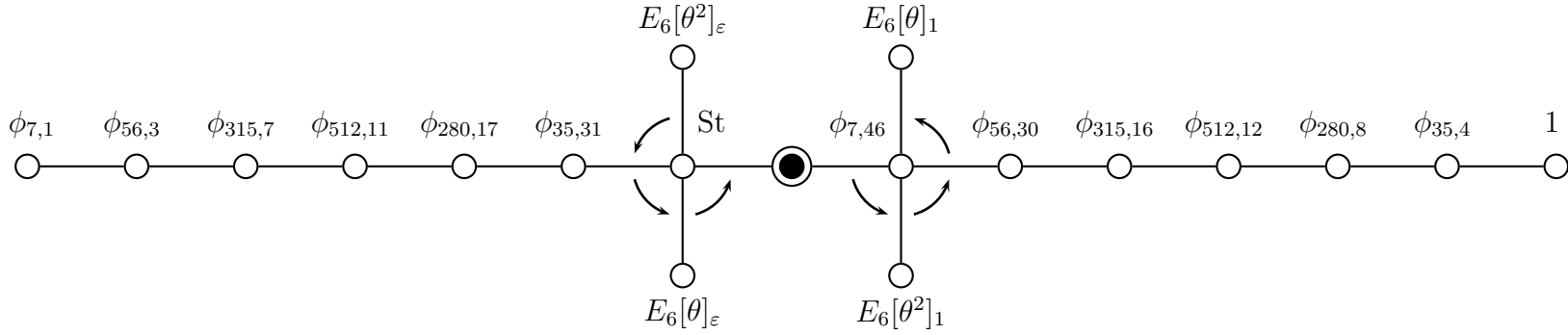

FIGURE 9. Brauer tree of the principal Φ_9 -block of $E_7(q)$

The Φ_9 -blocks of $E_8(q)$ have isomorphic trees, with bijection of vertices given as follows.

$E_7(q)$	$\phi_{7,1}$	$\phi_{56,3}$	$\phi_{315,7}$	$\phi_{512,11}$	$\phi_{280,17}$	$\phi_{35,31}$	St	$E_6[\theta^2]_\epsilon$	$E_6[\theta]_\epsilon$
$E_8(q), (A_2, \phi_3)$	$\phi_{160,7}$	$\phi_{1008,9}$	$\phi_{2800,13}$	$\phi_{5600,21}$	$\phi_{4096,27}$	$\phi_{560,47}$	$\phi_{112,63}$	$E_6[\theta^2]_{\phi'_{1,3}}$	$E_6[\theta]_{\phi'_{1,3}}$
$E_8(q), (A_2, \phi_{21})$	$\phi_{35,2}$	$\phi_{700,6}$	$\phi_{2240,10}$	$\phi_{3150,18}$	$\phi_{2240,28}$	$\phi_{700,42}$	$\phi_{35,74}$	$E_6[\theta^2]_{\phi_{2,2}}$	$E_6[\theta]_{\phi_{2,2}}$
$E_8(q), (A_2, \phi_{1^3})$	$\phi_{112,3}$	$\phi_{560,5}$	$\phi_{4096,11}$	$\phi_{5600,15}$	$\phi_{2800,25}$	$\phi_{1008,39}$	$\phi_{160,55}$	$E_6[\theta^2]_{\phi'_{1,3}}$	$E_6[\theta]_{\phi'_{1,3}}$
$E_7(q)$	$\phi_{7,46}$	$\phi_{56,30}$	$\phi_{315,16}$	$\phi_{512,12}$	$\phi_{280,8}$	$\phi_{35,4}$	1	$E_6[\theta^2]_1$	$E_6[\theta]_1$
$E_8(q), (A_2, \phi_3)$	$\phi_{28,68}$	$\phi_{1575,34}$	$\phi_{4096,26}$	$\phi_{3200,22}$	$\phi_{700,16}$	$\phi_{50,8}$	1	$E_6[\theta^2]_{\phi_{1,0}}$	$E_6[\theta]_{\phi_{1,0}}$
$E_8(q), (A_2, \phi_{21})$	$\phi_{8,91}$	$\phi_{400,43}$	$\phi_{1400,29}$	$\phi_{2016,19}$	$\phi_{1400,11}$	$\phi_{400,7}$	$\phi_{8,1}$	$E_6[\theta^2]_{\phi_{2,1}}$	$E_6[\theta]_{\phi_{2,1}}$
$E_8(q), (A_2, \phi_{1^3})$	$\phi_{1,120}$	$\phi_{50,56}$	$\phi_{700,28}$	$\phi_{3200,16}$	$\phi_{4096,12}$	$\phi_{1575,10}$	$\phi_{28,8}$	$E_6[\theta^2]_{\phi_{1,6}}$	$E_6[\theta]_{\phi_{1,6}}$

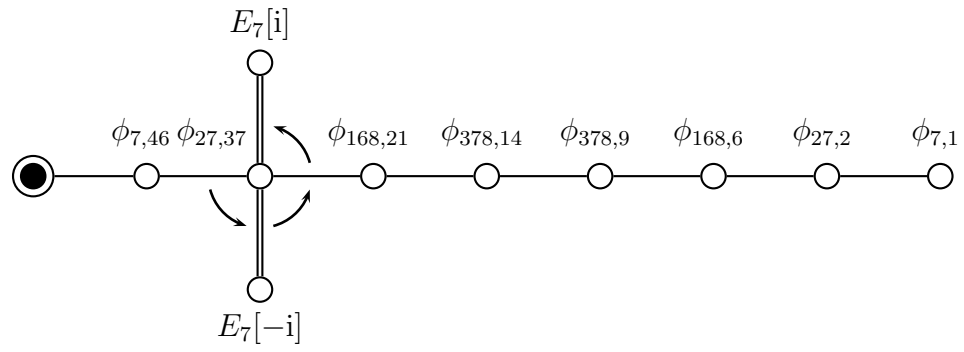

FIGURE 10. Brauer tree of the Φ_{10} -block of $E_7(q)$ associated to $({}^2A_2(q).(q^5 + 1), \phi_{21})$

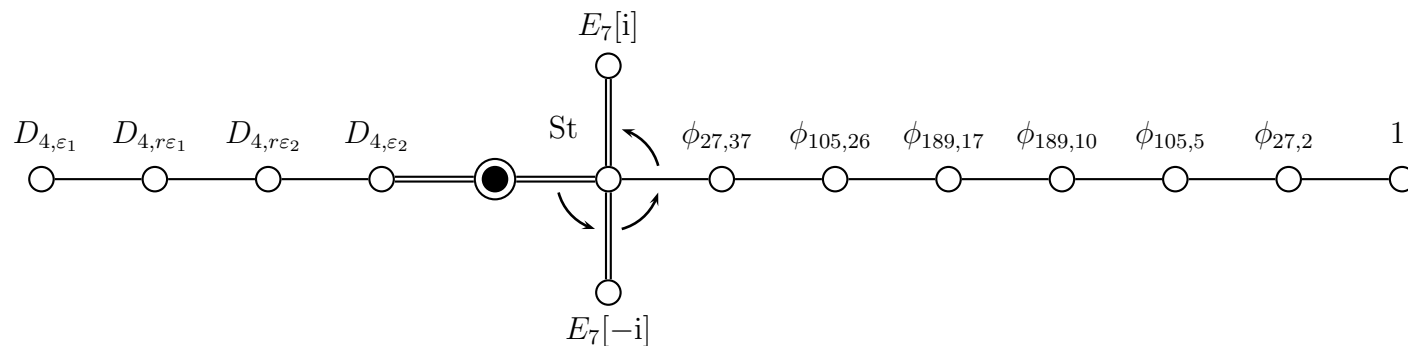

FIGURE 11. Brauer tree of the principal Φ_{14} -block of $E_7(q)$

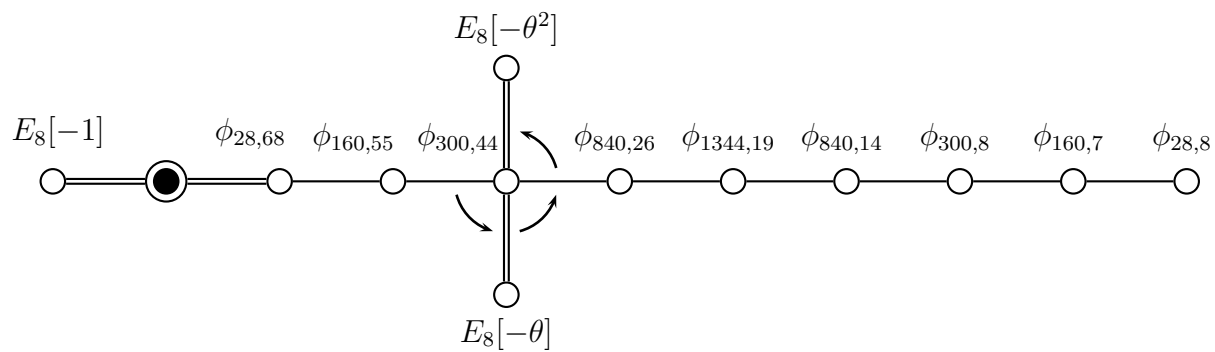

FIGURE 12. Brauer tree of the Φ_{12} -block of $E_8(q)$ associated to $({}^3D_4(q), {}^3D_4[1])$

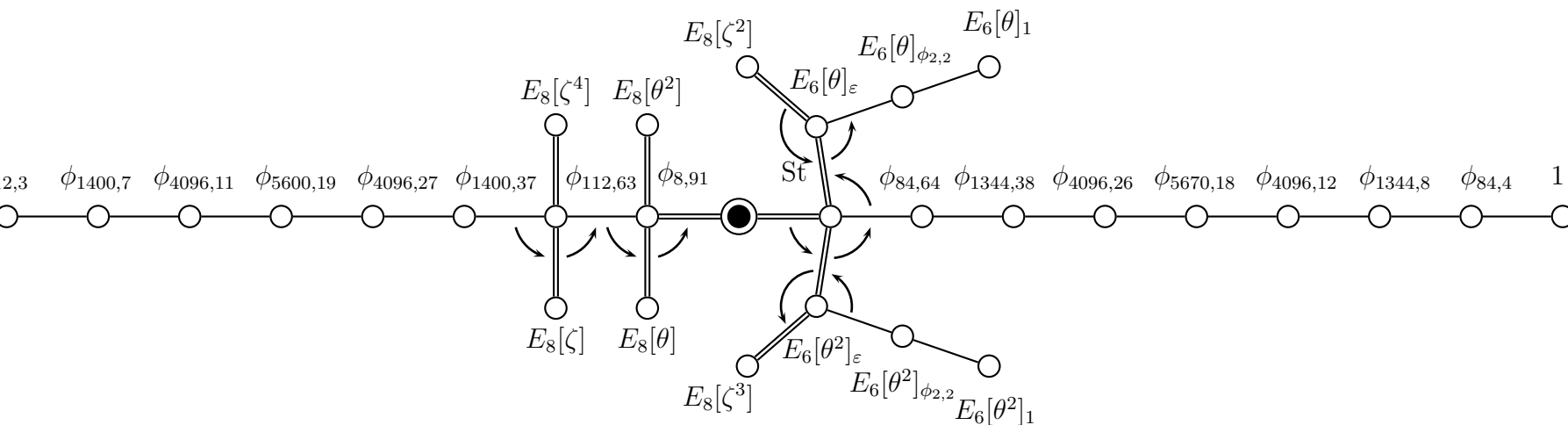

FIGURE 13. Brauer tree of the principal Φ_{15} -block of $E_8(q)$

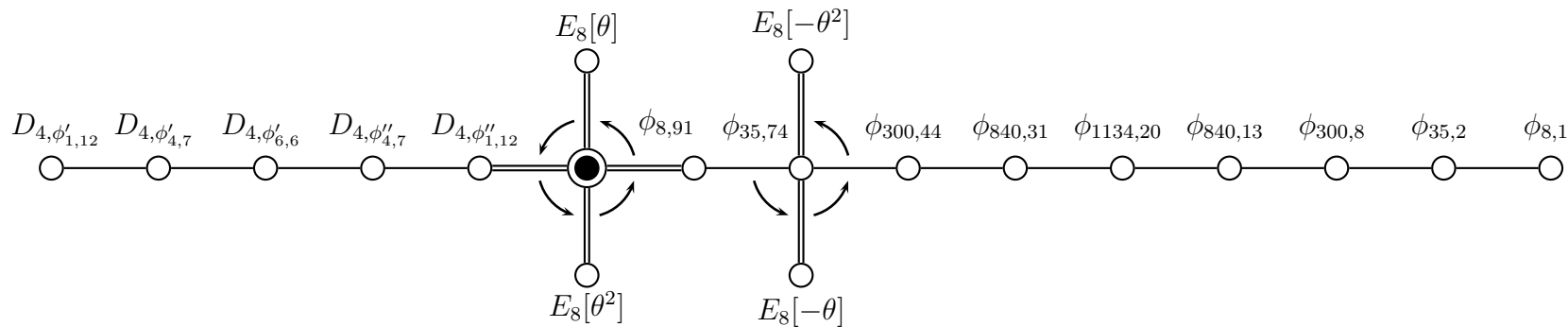

FIGURE 14. Brauer tree of the Φ_{18} -block of $E_8(q)$ associated to $({}^2A_2(q), \phi_{21})$

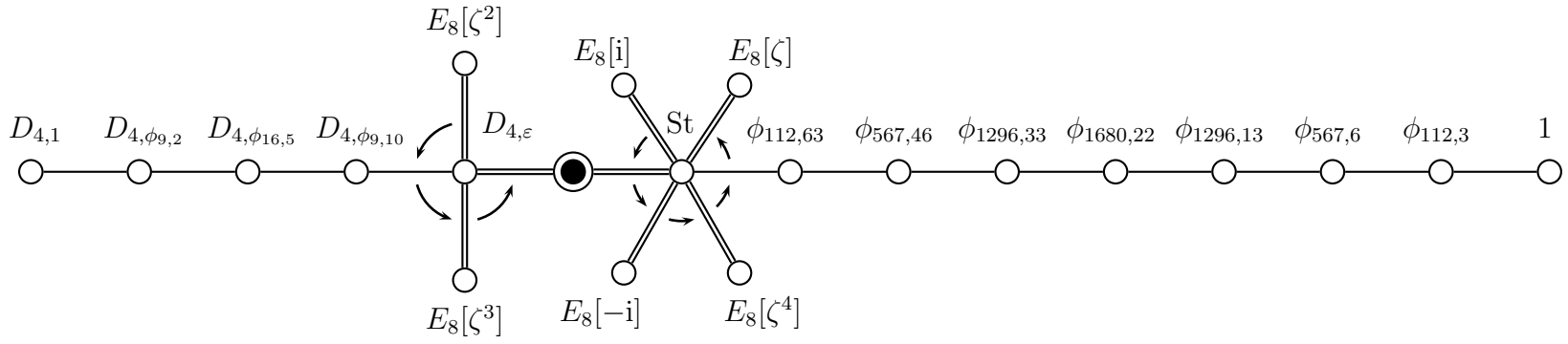
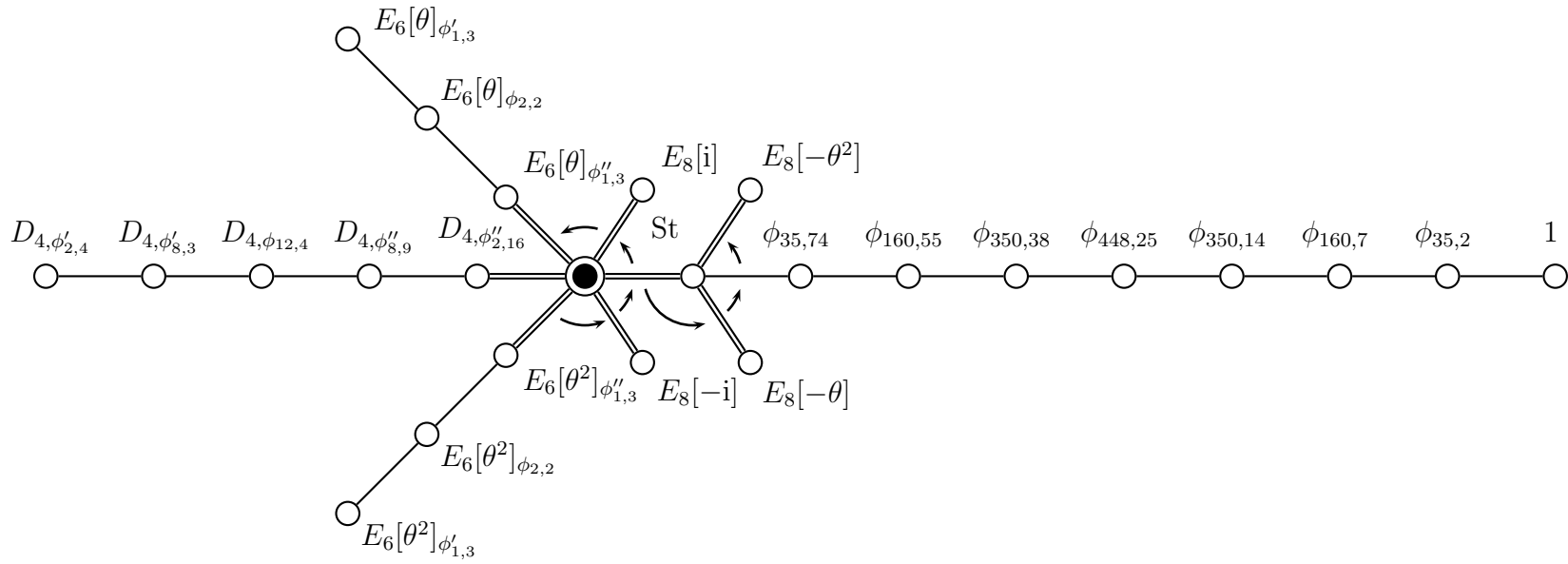

FIGURE 15. Brauer tree of the principal Φ_{20} -block of $E_8(q)$

FIGURE 16. Brauer tree of the principal Φ_{24} -block of $E_8(q)$

REFERENCES

- [1] C. Bonnafé, J.-F. Dat and R. Rouquier, Derived categories and Deligne-Lusztig varieties II. *Ann. Math.* 185 (2017), 609–670.
- [2] C. Bonnafé and J. Michel. Computational proof of the Mackey formula for $q > 2$. *J. Algebra* 327 (2011), 506–526.
- [3] C. Bonnafé and R. Rouquier. Catégories dérivées et variétés de Deligne-Lusztig. *Publ. Math. Inst. Hautes Études Sci.* 97 (2003), 1–59.
- [4] C. Bonnafé and R. Rouquier. Coxeter orbits and modular representations. *Nagoya Math. J.* 183 (2006), 1–34.
- [5] R. Brauer. Investigations on group characters. *Ann. of Math.* 42 (1941), 936–958.
- [6] M. Broué. Isométries parfaites, types de blocs, catégories dérivées. *Astérisque* 181–182 (1990), 61–92.
- [7] M. Broué and G. Malle. Théorèmes de Sylow génériques pour les groupes réductifs sur les corps finis. *Math. Ann.* 292 (1992), 241–262.
- [8] M. Broué, G. Malle and J. Michel, Generic blocks of finite reductive groups. *Astérisque* 212 (1993), 7–92.
- [9] M. Broué, G. Malle and J. Michel. Towards spetses. I. *Transform. Groups* 4 (1999), 157–218.
- [10] M. Broué and J. Michel. Blocs et séries de Lusztig dans un groupe réductif fini. *J. Reine Angew. Math.* 395 (1989), 56–67.
- [11] M. Broué and J. Michel. Blocs à groupe de défaut abélien. *Astérisque* 212 (1993), 93–118.
- [12] O. Brunat. The Shintani descents of Suzuki groups and their consequences. *J. Algebra* 303 (2006), 869–890.
- [13] R. Burkhardt. Über die Zerlegungszahlen der Suzukigruppen $Sz(q)$. *J. Algebra* 59 (1979), 421–433.
- [14] M. Cabanes and M. Enguehard. Unipotent blocks of finite reductive groups of a given type. *Math. Zeitschrift* 213 (1993), 479–490.
- [15] M. Cabanes and M. Enguehard. On unipotent blocks and their ordinary characters. *Invent. Math.* 117 (1994), 149–164.
- [16] M. Cabanes and M. Enguehard. Representation theory of finite reductive groups. Cambridge Univ. Press, 2004.
- [17] J. Chuang and R. Rouquier. Perverse equivalences and Calabi-Yau algebras. In preparation.
- [18] G. Cooperman, G. Hiß, K. Lux and J. Müller. The Brauer tree of the principal 19-block of the sporadic simple Thompson group. *Experiment. Math.* 6 (1997), 293–300.
- [19] D. Craven. Perverse equivalences and Broué’s conjecture II: The cyclic case. submitted.
- [20] C.W. Curtis and I. Reiner. Methods of representation theory, vol. II. John Wiley, 1987.
- [21] E. C. Dade. Blocks with cyclic defect groups. *Ann. of Math.* 84 (1966), 20–48.
- [22] P. Deligne and G. Lusztig. Duality for representations of a reductive group over a finite field, II. *J. Algebra* 81 (1983), 540–545.
- [23] F. Digne and J. Michel. Representations of finite groups of Lie type. Cambridge University Press, 1991.
- [24] F. Digne and J. Michel. Groupes réductifs non connexes. *Ann. Sci. ENS* 27 (1994), 345–406.
- [25] F. Digne, J. Michel and R. Rouquier. Cohomologie des variétés de Deligne-Lusztig. *Adv. Math.* 209 (2007), 749–822.
- [26] R. Dipper. On quotient of Hom-functors and representations of finite general linear groups. I. *J. Algebra* 130 (1990), 20–52.
- [27] O. Dudas. Deligne-Lusztig restriction of a Gelfand-Graev module. *Ann. Sci. Éc. Norm. Supér.* 42 (2009), 653–674.
- [28] O. Dudas. Coxeter Orbits and Brauer trees. *Adv. Math.* 229 (2012), 3398–3435.

- [29] O. Dudas. Coxeter Orbits and Brauer trees II. *Int. Math. Res. Not.* 15 (2014), 4100–4123.
- [30] O. Dudas and R. Rouquier. Coxeter Orbits and Brauer trees III. *J. Amer. Math. Soc.* 27 (2014), 1117–1145.
- [31] M. Enguehard. Sur les ℓ -blocs des groupes réductifs finis quand ℓ est mauvais. *Journal of Algebra* 230 (2000), 334–377.
- [32] W. Feit. Possible Brauer trees. *Illinois J. Math.* 28 (1984), 43–56.
- [33] W. Feit. The representation theory of finite groups. North-Holland, 1982.
- [34] P. Fong and M. Harris. On perfect isometries and isotypies in finite groups. *Invent. Math.* 114 (1993), 139–191.
- [35] P. Fong and B. Srinivasan. Brauer trees in $GL_n(q)$. *Math. Z.* 187 (1984), 81–88.
- [36] P. Fong and B. Srinivasan. Brauer trees in classical groups. *J. Algebra* 131 (1990), 179–225.
- [37] M. Geck. Verallgemeinerte Gelfand–Graev Charaktere und Zerlegungszahlen endlicher Gruppen. *Dissertation*, Aachen (1990).
- [38] M. Geck. Generalized Gelfand–Graev characters for Steinberg’s triality groups and their applications. *Comm. Algebra* 19 (1991), 3249–3269.
- [39] M. Geck. Brauer trees of Hecke algebras. *Comm. Algebra* 20 (1992), 2937–2973.
- [40] M. Geck. Kazhdan–Lusztig cells and decomposition numbers. *Represent. Theory* 2 (1998), 264–277.
- [41] M. Geck. Character values, Schur indices and character sheaves. *Represent. Theory* 7 (2003), 19–55.
- [42] M. Geck, G. Hiss and G. Malle. Cuspidal unipotent Brauer characters. *J. Algebra* 168 (1994), 182–220.
- [43] M. Geck and G. Pfeiffer. On the irreducible characters of Hecke algebras. *Adv. Math.* 102 (1993), 79–94.
- [44] M. Geck and G. Pfeiffer. *Characters of finite Coxeter groups and Iwahori–Hecke algebras*. The Clarendon Press Oxford University Press, 2000.
- [45] M. Geck and G. Pfeiffer and S. Kim. Minimal length elements in twisted conjugacy classes of finite Coxeter groups. *J. Algebra* 229 (2000), 570–600.
- [46] G. Hiss. Regular and semisimple blocks of finite reductive groups. *J. London Math. Soc.* 41 (1990), 63–68.
- [47] G. Hiss. The Brauer trees of the Ree groups. *Comm. Algebra* 19 (1991), 871–888.
- [48] G. Hiss and F. Lübeck. The Brauer trees of the exceptional Chevalley groups of types F_4 and 2E_6 . *Arch. Math. (Basel)* 70 (1998), 16–21.
- [49] G. Hiss, F. Lübeck and G. Malle. The Brauer trees of the exceptional Chevalley groups of type E_6 . *Manuscripta Math.* 87 (1995), 131–144.
- [50] G. Hiss and K. Lux. *Brauer trees of sporadic groups*. Oxford University Press, 1989.
- [51] J. E. Humphreys. *Reflection groups and Coxeter groups*. Cambridge Univ. Press, 1990.
- [52] M. Linckelmann. Le centre d’un bloc à groupes de défaut cycliques. *Comptes Rendus de l’Académie des Sciences* 306 (1988), 727–730.
- [53] M. Linckelmann. Trivial source bimodule rings for blocks and p -permutation equivalences. *Transactions Amer. Math. Soc.* 361 (2009), 1279–1316.
- [54] G. Lusztig. Representations of finite Chevalley groups. *Regional Conf. Series in Math.* 39, Amer. Math. Soc. 1978.
- [55] G. Lusztig. Coxeter orbits and eigenspaces of Frobenius. *Invent. Math.* 38 (1976), 101–159.
- [56] G. Lusztig. Homology bases arising from reductive groups over a finite field. In *Algebraic groups and their representations (Cambridge, 1997)*, volume 517 of *NATO Adv. Sci. Inst. Ser. C Math. Phys. Sci.*, pp. 53–72.
- [57] G. Lusztig. Rationality properties of unipotent representations. *J. Algebra* 258 (2002), 1–22.

- [58] G. Lusztig and N. Spaltenstein. Induced unipotent classes. *J. London Math. Soc.* 19 (1979), 41–52.
- [59] G. Malle. Die unipotenten Charaktere von ${}^2F_4(q^2)$. *Comm. Algebra* 18 (1990), 2361–2381.
- [60] G. Malle and D. Testerman. Linear algebraic groups and finite groups of Lie type. Cambridge University Press, 2011.
- [61] J. Michel. The development version of the CHEVIE package of GAP3. *J. Algebra* 435 (2015), 308–336.
- [62] J. Müller. Brauer trees for the Schur cover of the symmetric group. *J. Algebra* 266 (2003), 427–445.
- [63] R. Rouquier. Complexes de chaînes étales et courbes de Deligne-Lusztig. *J. Algebra* 257 (2002), 482–508.
- [64] J. Shamash. Brauer trees for blocks of cyclic defect in the groups $G_2(q)$ for primes dividing $q^2 \pm q + 1$. *J. Algebra* 123 (1989), 378–396.
- [65] H. N. Ward. On Ree’s series of simple groups. *Trans. Amer. Math. Soc.* 121 (1966), 62–89.
- [66] E. Wings. Über die unipotenten Charaktere der Gruppen $F_4(q)$. Dissertation, Lehrstuhl D für Mathematik, RWTH Aachen, 1995.

SCHOOL OF MATHEMATICS, UNIVERSITY OF BIRMINGHAM, EDGBASTON, BIRMINGHAM B15 2TT, UK.

E-mail address: `d.a.craven@bham.ac.uk`

UNIVERSITÉ PARIS DIDEROT, UFR DE MATHÉMATIQUES, BÂTIMENT SOPHIE GERMAIN, 5 RUE THOMAS MANN, 75205 PARIS CEDEX 13, FRANCE.

E-mail address: `olivier.dudas@imj-prg.fr`

UCLA MATHEMATICS DEPARTMENT, LOS ANGELES, CA 90095-1555, USA.

E-mail address: `rouquier@math.ucla.edu`