

An undergraduate laboratory study of the polarisation of annihilation photons using Compton scattering

Nikolopoulos, Konstantinos; Tungate, Garry; Knights, Patrick

DOI:

[10.1088/1361-6404/aab334](https://doi.org/10.1088/1361-6404/aab334)

License:

Creative Commons: Attribution-NonCommercial-NoDerivs (CC BY-NC-ND)

Document Version

Peer reviewed version

Citation for published version (Harvard):

Nikolopoulos, K, Tungate, G & Knights, P 2018, 'An undergraduate laboratory study of the polarisation of annihilation photons using Compton scattering', *European Journal of Physics*. <https://doi.org/10.1088/1361-6404/aab334>

[Link to publication on Research at Birmingham portal](#)

Publisher Rights Statement:

Checked for eligibility: 15/03/2018

[10.1088/1361-6404/aab334](https://doi.org/10.1088/1361-6404/aab334)

<http://iopscience.iop.org/article/10.1088/1361-6404/aab334>

General rights

Unless a licence is specified above, all rights (including copyright and moral rights) in this document are retained by the authors and/or the copyright holders. The express permission of the copyright holder must be obtained for any use of this material other than for purposes permitted by law.

- Users may freely distribute the URL that is used to identify this publication.
- Users may download and/or print one copy of the publication from the University of Birmingham research portal for the purpose of private study or non-commercial research.
- User may use extracts from the document in line with the concept of 'fair dealing' under the Copyright, Designs and Patents Act 1988 (?)
- Users may not further distribute the material nor use it for the purposes of commercial gain.

Where a licence is displayed above, please note the terms and conditions of the licence govern your use of this document.

When citing, please reference the published version.

Take down policy

While the University of Birmingham exercises care and attention in making items available there are rare occasions when an item has been uploaded in error or has been deemed to be commercially or otherwise sensitive.

If you believe that this is the case for this document, please contact UBIRA@lists.bham.ac.uk providing details and we will remove access to the work immediately and investigate.



ACCEPTED MANUSCRIPT

An undergraduate laboratory study of the polarisation of annihilation photons using Compton scattering

To cite this article before publication: Patrick Knights *et al* 2018 *Eur. J. Phys.* in press <https://doi.org/10.1088/1361-6404/aab334>

Manuscript version: Accepted Manuscript

Accepted Manuscript is “the version of the article accepted for publication including all changes made as a result of the peer review process, and which may also include the addition to the article by IOP Publishing of a header, an article ID, a cover sheet and/or an ‘Accepted Manuscript’ watermark, but excluding any other editing, typesetting or other changes made by IOP Publishing and/or its licensors”

This Accepted Manuscript is © 2018 European Physical Society.

During the embargo period (the 12 month period from the publication of the Version of Record of this article), the Accepted Manuscript is fully protected by copyright and cannot be reused or reposted elsewhere.

As the Version of Record of this article is going to be / has been published on a subscription basis, this Accepted Manuscript is available for reuse under a CC BY-NC-ND 3.0 licence after the 12 month embargo period.

After the embargo period, everyone is permitted to use copy and redistribute this article for non-commercial purposes only, provided that they adhere to all the terms of the licence <https://creativecommons.org/licenses/by-nc-nd/3.0>

Although reasonable endeavours have been taken to obtain all necessary permissions from third parties to include their copyrighted content within this article, their full citation and copyright line may not be present in this Accepted Manuscript version. Before using any content from this article, please refer to the Version of Record on IOPscience once published for full citation and copyright details, as permissions will likely be required. All third party content is fully copyright protected, unless specifically stated otherwise in the figure caption in the Version of Record.

View the [article online](#) for updates and enhancements.

An undergraduate laboratory study of the polarisation of annihilation photons using Compton scattering

P. Knights¹, F. Ryburn²†, G. Tungate¹, K. Nikolopoulos¹

¹ School of Physics and Astronomy, University of Birmingham, B15 2TT, United Kingdom

² School of Physics and Astronomy, University of Oxford, OX1 3RH, United Kingdom

E-mail: k.nikolopoulos@bham.ac.uk

Abstract. An experiment for the advanced undergraduate laboratory which allows students to study the effect of photon polarisation in Compton scattering and to explore quantum entanglement is described. The quantum entangled photons are produced through electron-positron annihilation in the S -state, and their polarisations are analysed using the Compton scattering cross-section dependence on the photon polarisation. The experiment was equipped with off-the-shelf detectors and electronic units. Finite geometry effects are discussed and investigated with the use of a Geant4-based simulation.

Submitted to: *Eur. J. Phys.*

1. Introduction

Entanglement is an intriguing quantum mechanical phenomenon and the subject of the famous Einstein-Podolsky-Rosen (EPR) Paradox [1]. It was shown that a correlation exists between the quantum states of particles which had previously interacted even when they are no longer interacting. This leads to the classically paradoxical situation of apparent communication between particles separated by space-like intervals. This experimentally verified result of quantum mechanics [2, 3, 4] has profound implications in many fields including quantum computing and encryption.

An experiment is presented in which the effect of photon entanglement is explored. A pair of entangled photons, polarised at right angles to each other, are produced from positronium annihilation. Positronium, the bound state of an electron and a positron, is dominantly formed in a singlet S -state, where the electron and positron spins are anti-parallel [5]. This state has a mean lifetime of approximately 0.125 ns and decays preferentially via annihilation to produce two photons, each with an energy of 511 keV

† Ogden Trust Summer Intern at the University of Birmingham.

1
2
3 *Study of the polarisation of annihilation photons using Compton scattering* 2

4 traveling in opposite directions. For angular momentum conservation the two photons
5 must be produced in a polarisation state

$$6 \quad \phi = \frac{|xy\rangle - |yx\rangle}{\sqrt{2}} \quad (1)$$

7
8
9
10 where $|xy\rangle$ ($|yx\rangle$) denotes the state where the first photon is polarised in the x-plane
11 (y-plane) and the second in the y-plane (x-plane) [6, 7]. Subsequently, the two photons
12 travel to two “scatterers” where they undergo Compton scattering [8]. Given the
13 entangled nature of the photons the interaction of the first determines the polarisation
14 of the second. This connection, combined with the sensitivity of Compton scattering to
15 photon polarisation, results in an angular correlation of the scattered photons. Having
16 fixed the scattering plane of one of the photons this correlation is quantified by an
17 asymmetry in the number of times the other photon scatters into planes parallel and
18 perpendicular to the fixed plane. This angular correlation persists regardless of the
19 distance between the two “scatterers”. Similar experiments involving Compton scattered
20 annihilation photons have been proposed [5], conducted [9, 10, 11], and calculations
21 have been carried out [12, 7]. Recently, a similar experiment was proposed based on
22 semiconductor detectors for lecture demonstration of the photon entanglement [13].

23
24
25
26
27
28 Although the EPR paradox was a topic of extensive experimental study in the
29 mid-twentieth century, it remains mostly absent from the undergraduate laboratory.
30 Experiments to study photon entanglement have been proposed [14, 15] using photons
31 near the visible range of the electromagnetic spectrum. Nevertheless, the sensitivity
32 of Compton scattering on the photon polarisation provides the means to extend
33 such studies to γ -rays. This experiment complements a series of experiments on
34 Compton scattering using γ -rays that has been an important part of the undergraduate
35 laboratory for many decades. Various forms of such experiments have been proposed
36 and implemented, from the measurement of absorption coefficients to probe the
37 characteristics of the scattered photons [16], to experiments involving precision
38 spectroscopy and timing components [17, 18, 19] and experiments investigating
39 polarisation effects [20].

40
41
42
43
44
45 **2. Experimental Arrangement**

46
47 Consider two scatterers placed symmetrically about a positron source. The photons
48 released in annihilation will travel approximately back-to-back. Upon reaching a
49 scatterer, the first photon to interact through Compton scattering fixes the polarisation
50 plane. At that point the wavefunction collapses, ensuring that the polarisation of the
51 second photon is perpendicular to that of the first. Due to the polarisation dependence
52 of Compton scattering this causes the other photon to have a greater probability of
53 scattering into a plane perpendicular to that in which the first photon was scattered.
54 The possibility of photon interference is eliminated by setting the distance between the
55 two scatterers to be greater than the coherence length, which for photons produced from
56 S -state positronium decay is approximately 4 cm. The ratio of the number of photons
57
58
59
60

Study of the polarisation of annihilation photons using Compton scattering 3

scattered to the perpendicular plane, $N_{\phi=\frac{\pi}{2}}$, to the number of photons scattered to the parallel plane, $N_{\phi=0}$, is given by [7, 12]:

$$R = \frac{N_{\phi=\frac{\pi}{2}}}{N_{\phi=0}} = 1 + \frac{2 \sin^4 \theta}{\gamma^2 - 2\gamma \sin^2 \theta}, \quad (2)$$

where, $\gamma = 2 - \cos \theta + (2 - \cos \theta)^{-1}$, with θ the scattering angle and ϕ the azimuthal angle defined between the planes of scattering. This is presented in Figure 1 as a function of θ , showing that for a scattering angle of 90° the expected ratio is 2.60. In an actual experiment the detectors will subtend finite angles which will lead to a smearing of the asymmetry. This is shown by the dotted line in Figure 1 for the case where the detectors cover $\pm 20^\circ$ and $\pm 25^\circ$ around the nominal θ and ϕ angles, respectively.

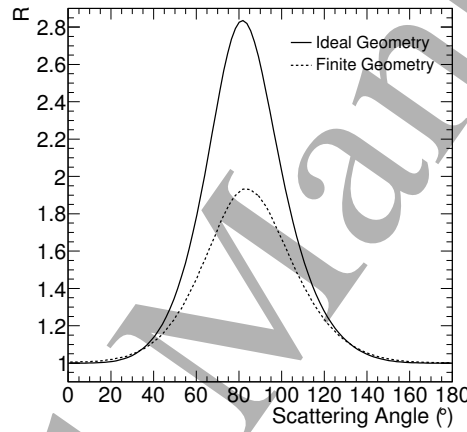

Figure 1. The asymmetry ratio, R , as a function of scattering angle, θ . The maximum of 2.84 is found at 82° . The effect of finite geometry is also demonstrated for the case where the detectors subtend angles of $\pm 20^\circ$ and $\pm 25^\circ$ around the nominal θ and ϕ angles, respectively.

The experiment consists of five cylindrical NaI(Tl) scintillation detectors, each 2" in diameter and length. Annihilation photons are obtained from a Germanium-68 source, which decays via electron capture to Gallium-68. This subsequently decays to Zinc-68 emitting a positron. The activity of the Germanium-68 source was approximately 4.4 kBq. Two cylindrical NaI(Tl) scintillators, Scatterer-1 and Scatterer-2, are placed symmetrically about the source with their faces at a distance of 16.2 cm. The centres of the scatterers were arranged to be 1.1 cm above the source along the z -axis to minimise the path a scattered photon travels through the crystal before it emerges towards a detector. The experimental layout is shown schematically in Figure 2(a).

An annihilation photon emerging from the source impinges on Scatterer-1 and is Compton scattered through 90° depositing 255.5 keV. The scattered photon, with energy 255.5 keV, then travels 11.4 cm to Detector-0 where it is absorbed and detected. The second annihilation photon travels in the opposite direction and Compton scatters in Scatterer-2 by 90° . The photon may then impinge on Detector-1 or Detector-2, where scattering to Detector-1 (Detector-2) is in a plane parallel (perpendicular) to the

Study of the polarisation of annihilation photons using Compton scattering 4

scattering of the first photon. The laboratory realisation of the experiment is shown in Figure 2(b), including the lead blocks used to shield the detectors from photons arriving directly from the source.

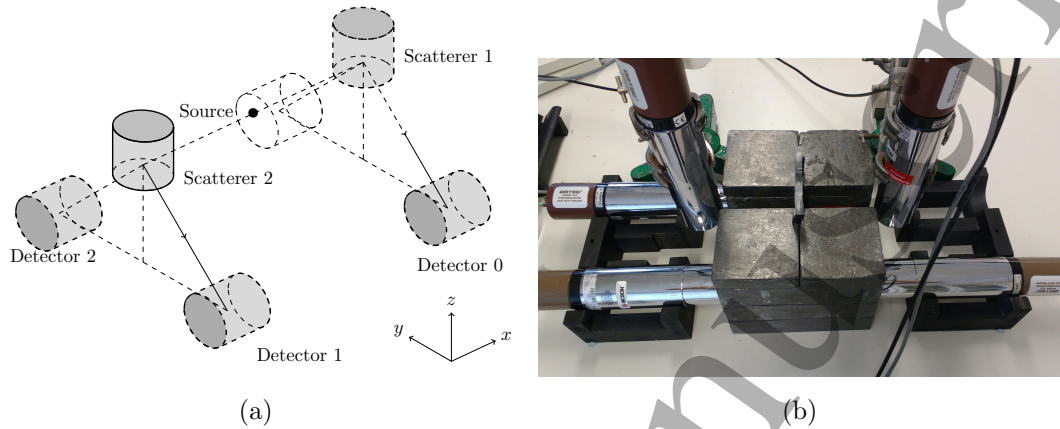

Figure 2. (a) Schematic diagram of the experimental set up showing the position of the source relative to the scatterers and detectors. (b) Photograph of the experimental set up showing the scatterers, detectors and the lead shielding.

From a Geant4 [21] simulation of the experiment it was obtained that 2.8% of photons produced by an isotropic positron source impinge on Scatterer-2. Of these, approximately 52% were fully absorbed, 43% Compton scattered before leaving the detector, while the remaining 5% did not interact with the detector. Approximately 0.013% of photons from the source arrive in Detector-1 having undergone Compton scattering in Scatterer-2.

3. Detector Calibration and Characterisation

Calibration of the detectors was performed using three radio-isotopes [22]: Germanium-68, Silver-108m and Americium-241. Silver-108m decays by electron capture to Palladium-108, emitting a number of photons, one being 434.0 keV. Americium-241 disintegrates by emission of an alpha particle to Neptunium-237, which releases a 59.5 keV photon. These data were also used to estimate the energy resolution of Detector-1 and Detector-2, which was found to be approximately 7.0% full-width at half-maximum for 511 keV. The timing of the detectors was synchronised using annihilation photons.

The Germanium-68 source and a coincidence technique were used to eliminate apparent asymmetries due to differences in efficiency between Detector-1 and Detector-2. The detectors were placed symmetrically about the source and detection of a signal in Detector-2 was gated by a signal compatible with a 511 keV photon in Detector-1 and vice-versa. The efficiencies of the two detectors were found to be $(24.8 \pm 0.5) \%$ and $(27.5 \pm 0.6) \%$ respectively for 511 keV photons.

4. Data Acquisition

The arrangement of electronic components for data acquisition is summarised in Figure 3. The signals from Detector-0, Scatterer-1, and Scatterer-2 were fed to three timing single-channel analysers (TSCA). Energy windows for Detector-0, Scatterer-1 and Scatterer-2 were set to accept signals corresponding to energies between approximately 200 keV and 310 keV, using a method similar to that employed in Ref. [20]. Subsequently, the TSCA signals were fed to a coincidence unit, with a resolving time of approximately $2 \mu\text{s}$, while the gate signal for Detector-1 and Detector-2 had a width of approximately $3 \mu\text{s}$.

Pulses from Detector-1 and Detector-2 were amplified, appropriately delayed and each fed into a multi-channel analyser. The logic pulse from the coincidence unit was used to gate the multi-channel analysers.

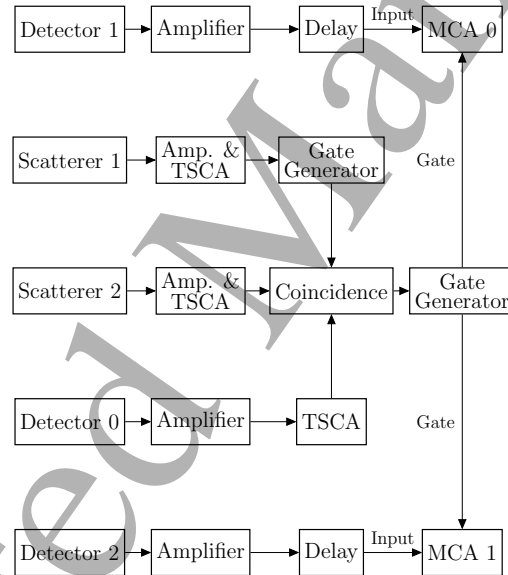

Figure 3. Block diagram of the electronic components.

The effect of the coincidence requirements on background was examined. When requiring three-fold coincidence of Detector-0, Scatterer-1 and Scatterer-2 a rate of approximately 8 s^{-1} was observed in Detector-1 and Detector-2. Removing Scatterer-1 from the coincidence does not significantly affect the rate, while removing Scatterer-2 causes the rate to increase by a factor of two. Removing both scatterers from coincidence leads to a further increase in the rate by approximately an order of magnitude. To estimate the background due to random coincidences further data were collected where the coincidence signal was delayed by $20 \mu\text{s}$.

5. Results

The distribution of energies for the two detectors following data collection for 20 hours is shown in Figure 4(a) and an asymmetry is readily observed. The peak at approximately ADC channel 850, corresponding to an energy of 255 keV, is the full energy peak from the absorption of the scattered photons. Additionally, X-rays from the excitation of lead atoms of the shielding can be seen at approximately ADC channel 250, corresponding to 80 keV. The position of the 511 keV line from a calibration run is also shown to set the energy scale.

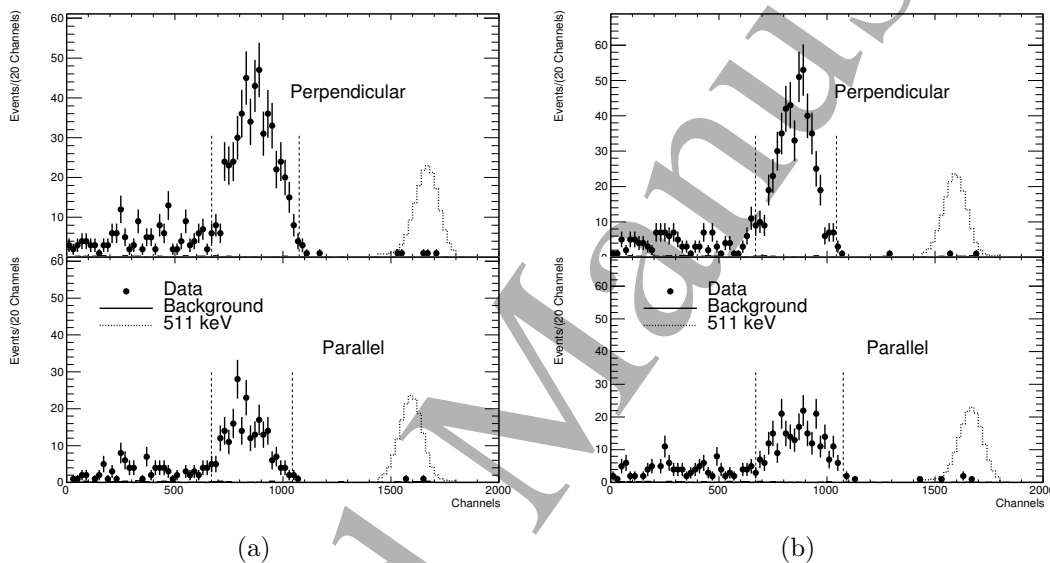

Figure 4. Results showing the asymmetry observed in the orthogonal planes for (a) Detector-0 located as shown in Figure 2, and (b) for Detector-0 moved to the location marked with a dashed cylinder. Perpendicular and Parallel refer to planes of scattering relative to scattering into Detector-0.

To obtain the numerical results the peaks were integrated in the region demarcated by the dashed vertical lines, corresponding to an energy range of 201 keV to 327 keV. The small background due to accidental coincidences was then subtracted from this and the measured ratio of perpendicular to parallel counts was taken giving a result of $R_1 = 2.35 \pm 0.19$. The measurement was repeated by moving Detector-0, as shown with the dashed cylinder in Figure 2(a), which effectively interchanged the roles of Detector-1 and Detector-2 as parallel and perpendicular. The distribution obtained is shown in Figure 4(b) and results in $R_2 = 1.99 \pm 0.15$.

Due to the finite solid angles subtended by the detectors and scatterers to each other and their finite extents, it is possible that some counting asymmetry may arise purely due to geometry. To better understand the results of the experiment, a simulation of the experimental set up has been produced using the Geant4 simulation toolkit [21] and is shown in Figure 5. To estimate the contribution of apparent asymmetry due to geometry effects to the observed overall asymmetry, the `G4EmLivermorePhysics` physics list was

Study of the polarisation of annihilation photons using Compton scattering 7

used, which neglects the effects of photon polarisation. The apparent asymmetry due to geometry was estimated to be $R_0 = 1.39 \pm 0.05$, indicating that the observed asymmetry is enhanced by the geometry. To reduce the influence of this apparent asymmetry on the observed asymmetry two variations of the experimental set-up were explored and are presented in Sections 6.1 and 6.2.

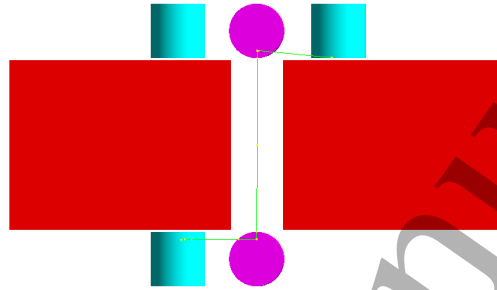

Figure 5. Experimental layout in Geant4 simulation. The scatterers are shown in purple, the detectors in teal, and the shielding in violet. The photon paths are shown in green.

To demonstrate the independence of the measured asymmetry from any interference, the measurement was repeated with the distance between the scatterers increased by a factor of three. This, correspondingly, decreases the solid angles subtended by each of the scatterers. The measurement was carried out for approximately three times longer and a value of $R = 1.90 \pm 0.19$ was obtained, while the apparent geometrical asymmetry was estimated to be $R_0 = 1.36 \pm 0.07$.

6. Variations on the Experimental Arrangement

6.1. Variation 1

In this variation of the experiment, shown in Figure 6, Scatterer-1 is replaced with a rectangle made of brass with dimensions $1.0 \text{ cm} \times 3.3 \text{ cm} \times 5.1 \text{ cm}$. From a Geant4 simulation it was determined that for this arrangement the apparent geometric asymmetry was substantially reduced to $R_0 = 1.04 \pm 0.01$. The orientation of the brass reduces the range of angles through which a photon can Compton scatter into the detectors. The results of this are shown in Figure 7(a) and give $R_1 = 1.77 \pm 0.12$. The measurement was repeated after changing the position of Detector-0 yielding $R_2 = 2.05 \pm 0.14$, shown in Figure 7(b). These data were collected over a period of 22 hours.

Study of the polarisation of annihilation photons using Compton scattering 8

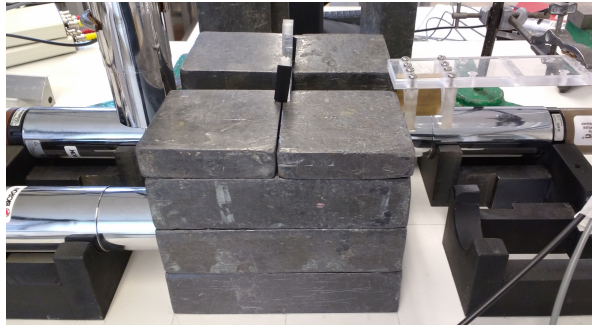

Figure 6. Variation 1 of the experiment. The scatterer made of brass is visible on the right-hand side of the photograph.

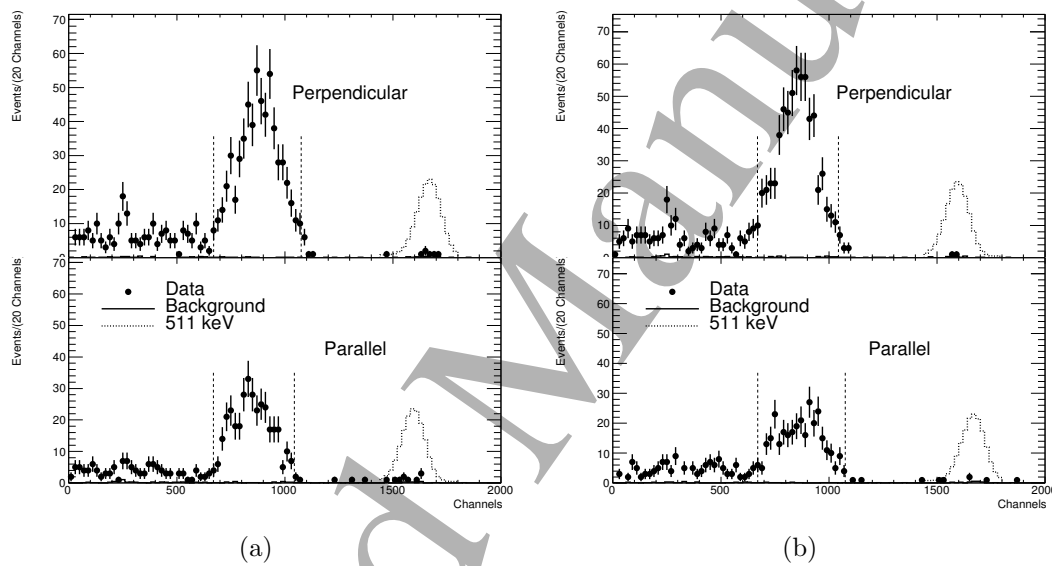

Figure 7. Results showing the asymmetry observed in the orthogonal planes for the first variant setup for (a) Detector-0 in the initial location and (b) when the location of Detector-0 was changed.

6.2. Variation 2

Variation 1 is further modified by replacing Scatterer-2 with a 1" NaI(Tl) scintillator. A Geant4 simulation of this set up gave an apparent asymmetry due to geometry of $R_0 = 1.08 \pm 0.02$. The results of 24 hours of data collection are shown in Figure 8 for the two repetitions of the experiment. Values of $R_1 = 1.94 \pm 0.19$ and $R_2 = 1.79 \pm 0.16$ were obtained.

7. Discussion

The presented experiment enables the observation of a correlation in polarisation between entangled annihilation photons by using the Compton effect. The experiment was carried out using a positron source available in the undergraduate laboratory. Data were collected over the course of a day or overnight. The results in each configuration

Study of the polarisation of annihilation photons using Compton scattering

9

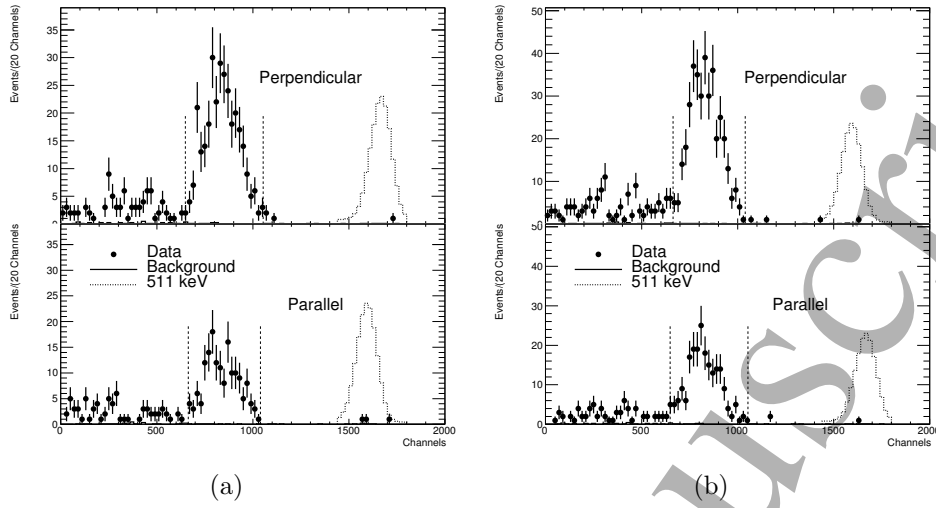

Figure 8. Results showing the asymmetry observed in the orthogonal planes for the second variant setup for (a) Detector-0 in the initial location and (b) when the location of Detector-0 was changed.

were compatible and are shown in Table 1.

Table 1. The experimental results for the initial experiment and the two variants. The averaged asymmetry between the two measurements is given with \bar{R} . Also given are the results on the apparent asymmetry, R_0 , due to geometry obtained with Geant4 simulations for each experimental arrangement. The expected asymmetry R_{the} is also shown, which accounts for the finite size of the detectors in each case.

Experiment	R_1	R_2	\bar{R}	R_0	\bar{R}/R_0	R_{the}
Initial Set Up	2.35 ± 0.19	1.99 ± 0.15	2.17 ± 0.12	1.39 ± 0.05	1.56 ± 0.10	1.8
Variation 1	1.77 ± 0.12	2.05 ± 0.14	1.91 ± 0.09	1.04 ± 0.01	1.84 ± 0.09	1.9
Variation 2	1.94 ± 0.19	1.79 ± 0.16	1.87 ± 0.12	1.08 ± 0.02	1.73 ± 0.12	1.9

Background was suppressed through coincidence requirements between the scatterers and detectors. In the initial experiment both scatterers were active. However, due to the dimensions of the crystals an apparent asymmetry arising from the geometry is observed. This is corrected for in the column labeled \bar{R}/R_0 in Table 1 where the ratio of the observed asymmetry to the expected geometric asymmetry is taken. Subsequently, the experiment was modified to reduce this geometric asymmetry. The results of Variations 1 and 2 of the experiment show that an overall asymmetry is still readily observable, while asymmetries due to purely geometric effects are estimated by Geant4 simulations to be significantly reduced.

Further to the improvements to the experimental arrangement the detectors subtend finite angles. It is estimated by means of the Geant4 simulation that for Variant 2 these are $\pm 20^\circ$ in θ and $\pm 25^\circ$ in ϕ , leading to an expected asymmetry of 1.9. The expected asymmetries in each variant are given in the right-most column of Table 1.

Another potential source of asymmetry, unrelated to the photon angular correlation,

Study of the polarisation of annihilation photons using Compton scattering 10

is a difference in the efficiencies of Detector-1 and Detector-2. Although it was experimentally verified that the two detectors had comparable efficiencies, within the statistical uncertainty of the asymmetry measurement, data were collected with Detector-0 moved to the location shown as a dashed cylinder in Figure 2(a). This effectively interchanges Detector-1 and Detector-2 as parallel and perpendicular.

Studying the background suppression from coincidence requirements it was shown that Scatterer-2 could be replaced by a passive scatterer without an appreciable increase in background. The main experiment employed four active scintillators. The first variant of the experiment demonstrates that an asymmetry is still observable when Scatterer-2 is replaced by a passive scatterer. The choice of size for Scatterer-2 can also be altered as demonstrated by the second variant, provided an appropriate amount of time is allocated for data collection. The experiment could be further simplified to three scintillators by moving a single detector between the positions of Detector-2 and Detector-1. This removes the need to ensure that Detector-1 and Detector-2 have the same efficiency, however, in the interest of time it was deemed useful to take data in parallel.

8. Summary

An experiment to demonstrate correlation of the polarisation of annihilation photons for the undergraduate laboratory is presented. A positron source was used to produce pairs of 511 keV photons travelling at 180° . These quantum entangled photons undergo Compton scatterings to produce asymmetries in numbers scattered to orthogonal planes. Lead shielding and coincidence requirements were implemented to reduce background events. Finite geometry effects and apparent asymmetries were discussed and several variations of the experiment were carried out to minimise such effects. The experiment provides a demonstration of the Compton scattering dependence on photon polarisation and of quantum entanglement while utilising experimental techniques such as coincidence circuits and background estimation in addition to the standard skills emphasised in the undergraduate laboratory.

Acknowledgments

This work was performed at the Year 3 Nuclear Physics Laboratory of the School of Physics and Astronomy at the University of Birmingham, where this exercise is now offered to undergraduate students. PK acknowledges support from the School of Physics and Astronomy during his summer placement. FR acknowledges support from the Ogden Trust Summer Internship program.

References

- [1] A. Einstein, B. Podolsky, and N. Rosen, "Can quantum-mechanical description of physical reality be considered complete?," *Phys. Rev.*, vol. 47, pp. 777–780, May 1935.

Study of the polarisation of annihilation photons using Compton scattering 11

- [2] S. J. Freedman and J. F. Clauser, "Experimental test of local hidden-variable theories," *Phys. Rev. Lett.*, vol. 28, pp. 938–941, Apr 1972.
- [3] A. Aspect, P. Grangier, and G. Roger, "Experimental tests of realistic local theories via bell's theorem," *Phys. Rev. Lett.*, vol. 47, pp. 460–463, Aug 1981.
- [4] A. Aspect, J. Dalibard, and G. Roger, "Experimental test of bell's inequalities using time-varying analyzers," *Phys. Rev. Lett.*, vol. 49, pp. 1804–1807, Dec 1982.
- [5] J. A. Wheeler, "Polyelectrons," *Annals of the New York Academy of Sciences*, vol. 48, pp. 219–238, 1946.
- [6] P. Dirac, "On the annihilation of electrons and protons," *Mathematical Proceedings of the Cambridge Philosophical Society*, vol. 26, pp. 361–375, 1930.
- [7] H. S. Snyder, S. Pasternack, and J. Hornbostel, "Angular correlation of scattered annihilation radiation," *Phys. Rev.*, vol. 73, pp. 440–448, 1948.
- [8] A. H. Compton, "A Quantum Theory of the Scattering of X-rays by Light Elements," *Phys. Rev.*, vol. 21, pp. 483–502, 1923.
- [9] C. S. Wu and I. Shakhov, "The Angular Correlation of Scattered Annihilation Radiation," *Phys. Rev.*, vol. 77, pp. 136–136, 1950.
- [10] L. R. Kasday, J. Ullman, and C. S. Wu, "Angular correlation of compton-scattered annihilation photons and hidden variables," *Il Nuovo Cimento B*, vol. 25, pp. 633–661, 1975.
- [11] A. R. Wilson, J. Lowe, and D. K. Butt, "Measurement of the relative planes of polarization of annihilation quanta as a function of separation distance," *Journal of Physics G: Nuclear Physics*, vol. 2, p. 613, 1976.
- [12] M. H. L. Pryce and J. C. Ward, "Angular correlation effects with annihilation radiation," *Nature*, vol. 160, pp. 435–435, 1947.
- [13] J. Hetfleis *et al.*, "Entangled γ -photons - classical laboratory exercise with modern detectors," *Eur. J. Phys.*, 2017.
- [14] D. Dehlinger and M. W. Mitchell, "Entangled photon apparatus for the undergraduate laboratory," *Am. J. Phys.*, vol. 70, p. 898, 2002.
- [15] D. Dehlinger and M. W. Mitchell, "Entangled photon apparatus for the undergraduate laboratory," *Am. J. Phys.*, vol. 70, p. 903, 2002.
- [16] A. A. Bartlett, "Compton effect: A simple laboratory experiment," *American Journal of Physics*, vol. 32, no. 2, pp. 127–134, 1964.
- [17] A. A. Bartlett, J. H. Wilson, O. W. Lyle, C. V. Wells, and J. J. Kraushaar, "Compton effect: an experiment for the advanced laboratory," *American Journal of Physics*, vol. 32, no. 2, pp. 135–142, 1964.
- [18] W. R. French, "Precision compton-effect experiment," *American Journal of Physics*, vol. 33, no. 7, pp. 523–527, 1965.
- [19] M. Stamatelatos, "Compton scattering experiment," *American Journal of Physics*, vol. 40, no. 12, pp. 1871–1872, 1972.
- [20] P. Knights, F. Ryburn, G. Tungate, and K. Nikolopoulos, "Studying the effect of Polarisation in Compton scattering in the undergraduate laboratory," *Eur. J. Phys.*, 2017.
- [21] S. Agostinelli *et al.*, "GEANT4: A Simulation toolkit," *Nucl. Instrum. Meth.*, vol. A506, pp. 250–303, 2003.
- [22] A. Sonzogni, "NNDC chart of nuclides," in *International Conference on Nuclear Data for Science and Technology*, pp. 105–106, EDP Sciences, 2007.