

# Characterization of the impact of *rpoB* mutations on the in vitro and in vivo competitive fitness of *Clostridium difficile* and susceptibility to fidaxomicin

Kuehne, Sarah A; Dempster, Andrew W; Collery, Mark M; Joshi, Nimitray; Jowett, Jamie; Kelly, Michelle L; Cave, Rory; Longshaw, Chris M; Minton, Nigel P

DOI:  
[10.1093/jac/dkx486](https://doi.org/10.1093/jac/dkx486)

License:  
Creative Commons: Attribution-NonCommercial (CC BY-NC)

*Document Version*  
Publisher's PDF, also known as Version of record

*Citation for published version (Harvard):*  
Kuehne, SA, Dempster, AW, Collery, MM, Joshi, N, Jowett, J, Kelly, ML, Cave, R, Longshaw, CM & Minton, NP 2018, 'Characterization of the impact of *rpoB* mutations on the in vitro and in vivo competitive fitness of *Clostridium difficile* and susceptibility to fidaxomicin', *Journal of Antimicrobial Chemotherapy*, vol. 73, no. 4, pp. 973-980. <https://doi.org/10.1093/jac/dkx486>

[Link to publication on Research at Birmingham portal](#)

**Publisher Rights Statement:**  
Checked for eligibility: 20/12/2017

## General rights

Unless a licence is specified above, all rights (including copyright and moral rights) in this document are retained by the authors and/or the copyright holders. The express permission of the copyright holder must be obtained for any use of this material other than for purposes permitted by law.

- Users may freely distribute the URL that is used to identify this publication.
- Users may download and/or print one copy of the publication from the University of Birmingham research portal for the purpose of private study or non-commercial research.
- User may use extracts from the document in line with the concept of 'fair dealing' under the Copyright, Designs and Patents Act 1988 (?)
- Users may not further distribute the material nor use it for the purposes of commercial gain.

Where a licence is displayed above, please note the terms and conditions of the licence govern your use of this document.

When citing, please reference the published version.

## Take down policy

While the University of Birmingham exercises care and attention in making items available there are rare occasions when an item has been uploaded in error or has been deemed to be commercially or otherwise sensitive.

If you believe that this is the case for this document, please contact [UBIRA@lists.bham.ac.uk](mailto:UBIRA@lists.bham.ac.uk) providing details and we will remove access to the work immediately and investigate.

## Characterization of the impact of *rpoB* mutations on the *in vitro* and *in vivo* competitive fitness of *Clostridium difficile* and susceptibility to fidaxomicin

Sarah A. Kuehne<sup>1-3</sup>, Andrew W. Dempster<sup>1</sup>, Mark M. Collery<sup>1†</sup>, Nimitray Joshi<sup>1</sup>, Jamie Jowett<sup>1</sup>, Michelle L. Kelly<sup>1</sup>, Rory Cave<sup>1</sup>, Chris M. Longshaw<sup>4‡</sup> and Nigel P. Minton<sup>1,2\*</sup>

<sup>1</sup>Clostridia Research Group, BBSRC/EPSRC Synthetic Biology Research Centre (SBRC), School of Life Sciences, University of Nottingham, Nottingham, UK; <sup>2</sup>Gastrointestinal and Liver Disorders Theme of the NIHR Nottingham Biomedical Research Centre (BRC), Nottingham University Hospitals NHS Trust and University of Nottingham, Nottingham, UK; <sup>3</sup>School of Dentistry, Institute of Clinical Sciences, College of Medical and Dental Sciences, University of Birmingham, Birmingham, UK; <sup>4</sup>Astellas Pharma Europe Ltd, Chertsey, UK

\*Corresponding author. Clostridia Research Group, BBSRC/EPSRC Synthetic Biology Research Centre (SBRC), School of Life Sciences, University of Nottingham, Nottingham NG7 2RD, UK. Tel: 44 (0)115 8467458; Fax: 44 (0)115 8230142; E-mail: nigel.minton@nottingham.ac.uk  
†Present address: Micropathology Ltd, University of Warwick Science Park, Coventry, UK.  
‡Present address: Basilea Pharmaceuticals Ltd, Guildford, UK.

Received 3 October 2017; revised 3 October 2017; accepted 25 November 2017

**Objectives:** To establish the role of specific, non-synonymous SNPs in the RNA polymerase  $\beta$  subunit (*rpoB*) gene in reducing the susceptibility of *Clostridium difficile* to fidaxomicin and to explore the potential *in vivo* significance of *rpoB* mutant strains.

**Methods:** Allelic exchange was used to introduce three different SNPs into the *rpoB* gene of an erythromycin-resistant derivative (CRG20291) of *C. difficile* R20291. The genome sequences of the created mutants were determined and each mutant analysed with respect to growth and sporulation rates, toxin A/B production and cytotoxicity against Vero cells, and in competition assays. Their comparative virulence and colonization ability was also assessed in a hamster infection model.

**Results:** The MIC of fidaxomicin displayed by three mutants CRG20291-TA, CRG20291-TG and CRG20291-GT was substantially increased (>32, 8 and 2 mg/L, respectively) relative to that of the parent strain (0.25 mg/L). Genome sequencing established that the intended mutagenic substitutions in *rpoB* were the only changes present. Relative to CRG20291, all mutants had attenuated growth, were outcompeted by the parental strain, had lower sporulation and toxin A/B production capacities, and displayed diminished cytotoxicity. In a hamster model, virulence of all three mutants was significantly reduced compared with the progenitor strain, whereas the degree of caecum colonization was unaltered.

**Conclusions:** Our study demonstrates that particular SNPs in *rpoB* lead to reduced fidaxomicin susceptibility. These mutations were associated with a fitness cost *in vitro* and reduced virulence *in vivo*.

### Introduction

*Clostridium difficile* is a spore-forming Gram-positive anaerobic bacillus that causes gastrointestinal infections in humans. *C. difficile* infection (CDI) is associated primarily with the use of antibiotics, which disrupts the resident gut microbiota and permits colonization.<sup>1</sup> Over the past decade, so-called ‘hypervirulent’ strains of *C. difficile* have become increasingly represented among clinical isolates, spreading throughout North America and Europe, and have been associated with outbreaks of increased disease

severity, higher relapse rates and an expanded repertoire of antibiotic resistance.<sup>2,3</sup> Such strains may have contributed to a rising incidence of CDI—particularly in elderly patients—and an increase in recurrent CDI.<sup>4</sup> The US CDC recently identified CDI as an ‘urgent threat’.<sup>3</sup>

Primary treatment of CDI often involves either metronidazole or vancomycin, which both cause further damage to the colonic microbiota;<sup>5</sup> recurrent infection following treatment is seen in 20%–30% of patients.<sup>6</sup> *C. difficile* is intrinsically resistant to many

**Table 1.** Random mutants in *rpoB* conferring reduced susceptibility to fidaxomicin<sup>10</sup>

Nucleotide change	Amino acid change	MIC (mg/L) of fidaxomicin
T3428A (TA)	Val1143Asp	>64
T3428G (TG) <sup>a</sup>	Val1143Gly	16
G3427T (GT)	Val1143Phe	2

<sup>a</sup>Clinical isolate collected from a patient presenting with CDI recurrence 6 days after completion of fidaxomicin therapy.

broad-spectrum antibiotics, which facilitates its spread within the hospital environment,<sup>3</sup> and *C. difficile* clinical isolates with reduced susceptibility to metronidazole have been identified.<sup>7</sup> Furthermore, an increased number of strains show reduced susceptibility to rifamycin antibiotics, which have been used to treat relapsing CDI.<sup>8</sup> Efforts to understand the nature of these susceptibility changes are warranted to control the growing threat of antibiotic resistance.

Fidaxomicin is a macrocyclic antibiotic that exhibits potent activity against *C. difficile* by inhibiting bacterial RNA synthesis.<sup>9</sup> It interferes with the formation of the DNA–RNA polymerase complex before the initiation of transcription.<sup>10</sup> Contrary to the bacteriostatic action of the macrolides and rifamycins, it is bactericidal and has been shown to be narrow-spectrum. Only moderate activity has been reported against *Staphylococcus aureus* and *Enterococcus*, and no activity reported against *Bacteroides* and other Gram-negative bacteria found in the normal human gut microflora.<sup>11</sup> In clinical trials, fidaxomicin has been shown to be non-inferior to vancomycin as an initial clinical cure for CDI, with a dosing regimen of 200 mg twice daily for 10 days. It had minimal side effects, was well tolerated and in addition, as it is hardly adsorbed, led to very low concentrations in the plasma of patients, but high concentrations in their faeces.<sup>12,13</sup> Importantly, fidaxomicin significantly reduces recurrences compared with vancomycin.<sup>14</sup>

*C. difficile* strains with point mutations with reduced susceptibility to fidaxomicin were previously isolated using either a single-step or multiple-passage approach (and one strain was isolated from a patient in a clinical trial).<sup>15</sup> The single-step approach generated mutant strains with point mutations in the gene encoding the  $\beta$  subunit of RNA polymerase, *rpoB*, although any potential variations in other genes that may have influenced susceptibility were not investigated at the time. Different SNPs led to replacement by three different amino acids, which in turn led to variable fidaxomicin MIC elevations (Table 1).<sup>15</sup> As fidaxomicin had a decreased ability to inhibit transcription by these RNA polymerase mutants, RNA polymerase target modification was suggested as the mechanism by which *C. difficile* could develop resistance to fidaxomicin,<sup>15</sup> although this requires further verification. Polymorphisms in other genes may also be associated with reduced susceptibility to fidaxomicin, such as *marR/CD22120*.<sup>16</sup> The MarR (multiple antibiotic resistance regulator) family of transcription factors is ubiquitous in bacteria and archaea. Many are implicated in the regulation of an operon encoding an efflux pump. Mutations within the operon can lead to multiple antibiotic resistances.<sup>17</sup> The clinical impact of fidaxomicin MIC elevations is unknown.

This study aimed to use an allelic exchange approach to recreate, *in situ* within *rpoB*, the point mutations potentially responsible for elevated fidaxomicin MICs, but within a clean, isogenic background. The subsequent phenotypic characteristics, competitive fitness and virulence of the isogenic mutants in the *in vivo* hamster model of CDI were investigated to understand the potential clinical significance of polymorphisms responsible for reduced *C. difficile* susceptibility to fidaxomicin.

## Materials and methods

### Ethics

All animal procedures were carried out in accordance with the United Kingdom Home Office Inspectorate under the Animals (Scientific Procedures) Act 1986. All experiments were approved by the University of Nottingham Ethics committee and carried out under licence number 40/3950.<sup>18,19</sup>

### Antibiotics, bacterial strains and growth conditions

*C. difficile* strain CRG20291<sup>19</sup> is a deliberately engineered erythromycin-resistant derivative of the PCR-ribotype 027 R20291 strain isolated from a UK outbreak.<sup>2</sup> It was grown anaerobically at 37°C in a Don Whitley workstation in brain heart infusion medium supplemented with 5 mg/mL yeast extract and 0.1% (w/v) L-cysteine (BHIS) or in tryptone yeast (TY) broth. *C. difficile* medium was supplemented with 250 mg/L D-cycloserine, 8 mg/L cefoxitin and/or 15 mg/L thiamphenicol, when appropriate. *Escherichia coli* TOP10 (Invitrogen) and *E. coli* CA434 were cultured aerobically at 37°C in LB broth, supplemented with 25 mg/L chloramphenicol,<sup>20</sup> when appropriate.

### Generation of *C. difficile* mutant strains by allelic exchange

The desired single nucleotide changes were introduced into the *C. difficile* genome using the previously described vector pMTL-YN4,<sup>21</sup> but with a number of key differences. Plasmid pMTL-YN4 carries a functional copy of a *Clostridium sporogenes*-derived *pyrE* gene, which can be used as a counter-selection marker for double crossover mutants, provided the *C. difficile* recipient is a *pyrE* mutant. However, we made use of an R20291*pyrE*-derivative strain (CRG20291) that was both macrolide, lincosamide, streptogramin (MLS) resistant and prototrophic through the genomic integration of an *erm(B)* gene at the *pyrE* locus,<sup>19</sup> concomitant with restoration of the *pyrE* gene to WT. The *C. difficile* strain CRG20291 was chosen because the use of R20291 in the Golden Syrian hamster is complicated by the susceptibility of R20291 to clindamycin (MIC, 16 mg/L).<sup>19</sup> Clindamycin treatment disrupts the hamsters' normal gut flora prior to infection with *C. difficile*. However, clindamycin can persist at inhibitory levels (4–6 µg/g) 11 days following administration,<sup>22</sup> and can affect the time from infection to colonization and death of strains with different clindamycin MICs.<sup>23</sup> CRG20291 has been shown to provide more reliable results in the *in vivo* hamster infection model.<sup>19</sup>

### Directed mutagenesis

Directed mutagenesis was performed in the progenitor strain, *C. difficile* CRG20291, to generate three *rpoB* SNPs (Table 1).<sup>15</sup> An allelic exchange cassette was synthesized (Biomatik) complementary to the *rpoB* region comprising 500 bp on either side of *rpoBT3428A* and containing the promoter region upstream of *rpoB* (Figure 1). The cassette also incorporated flanking restriction sites for SacI and MluI. Following cleavage with the corresponding restriction enzymes, DNA fragments were cloned into the knock-out vector, pMTL-YN4,<sup>21</sup> to give pMTL-YN4:*rpoBT3428A*. The construct was verified for the inclusion of the mutated region by restriction digest and

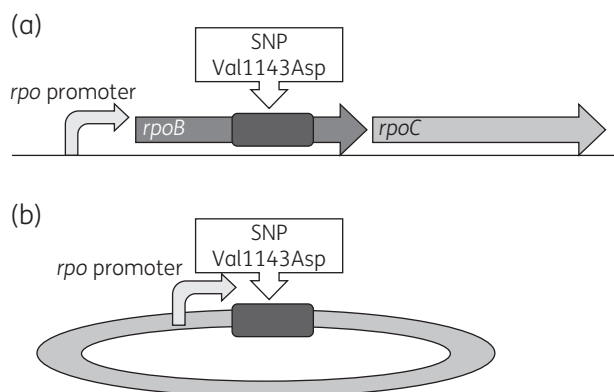

**Figure 1.** Graphic representation of the directed mutagenesis approach used in the study. (a) A section of the *C. difficile* genome. (b) The allelic exchange plasmid. (a) Arrangement of *rpoB* and *rpoC* in the *C. difficile* chromosome and the promoter that drives gene expression of *rpoB* and *rpoC*. The dark grey rectangle represents the 1 kb exchange cassette containing the nucleotide that was replaced. (b) The *rpoB* promoter and the 1 kb homology arms containing the SNP. Using homologous recombination, valine is turned into aspartic acid when *rpoB* is translated.

sequencing. Site-directed mutagenesis (Q5<sup>®</sup> site-directed mutagenesis kit NEB) was used to create the other two exchange vectors (pMTL-YN4: *rpoBT3428G* and pMTL-YN4: *rpoBG3427T*). These were also verified by Sanger sequencing.

The three verified plasmids were transformed into *E. coli* CA434 and conjugated into *C. difficile* CRG20291.<sup>19</sup> After conjugation, transconjugants were selected on BHIS thiamphenicol and purified colonies carrying the modified *rpoB* gene conferring resistance were restreaked on BHIS agar supplemented with 0.5 mg/L fidaxomicin (equivalent to 2 × MIC). Purified colonies were checked for plasmid loss, and purified DNA used for PCR amplification of a region containing the changed nucleotide.<sup>19</sup> Mutations were verified by Sanger sequencing.

## WGS

Three clones of each mutant were verified by whole-genome sequencing, genomic DNA concentrations were measured using the Qubit dsDNA BR assay kit (Q32850, Thermo Fisher Scientific) and DNA integrity was assessed using conventional gel electrophoresis. Standard fragment sequencing libraries were prepared according to the Illumina TruSeq PCR free library preparation kit (#FC-121-3001, Illumina). Genomic DNA (2 µg) was fragmented to 400–600 bp using the Covaris S2 sonicator. Fragmented DNA was purified using Agencourt AMPure XP beads (#A63881, Beckman Coulter) at 1:1.6 DNA:bead ratio and end-repaired at 30°C for 30 min. End-repaired DNA was size-selected using AMPure XP beads at the desired fragment length. Illumina sequencing Y adapters were ligated at 30°C for 10 min and incubated at 70°C for 5 min. Unligated adapters were removed with a further two rounds of purification at 1:1 DNA:bead ratio. Purified adapter-ligated DNA was quantified by qPCR (#KK4824, Kapa Biosystems, Inc.), and libraries were pooled at equimolar concentrations. The library pool was loaded at a final concentration of 10 pM on the MiSeq sequencer for cluster generation and sequencing using 2 × 250 bp paired-end reads on a full MiSeq run.

The genome sequences were compared with CRG20291 using the quality-based variant detection workflow from CLC Genomics Workbench.

## In vitro testing of *C. difficile* parental and mutant strains

### MICs of fidaxomicin

The MICs of fidaxomicin for the parental strain and the three mutant strains were determined by agar dilution according to CLSI standards.<sup>24</sup> All assays were performed in triplicate.

### Phenotypic characterization

The three generated strains were characterized and compared with the parental strain for: growth; growth in competition; sporulation rate and capacity; toxin A/B production; and cytotoxicity. All *in vitro* experiments were performed in triplicate.

**Growth curves** Mutant and parental strains were grown overnight, the OD<sub>600</sub> was standardized and a 1:10 dilution of each strain inoculated into fresh BHIS broth. Growth was analysed using a plate reader, with measurements taken every hour for 24 h.

**Competition assays** Mutant and parental strains were grown overnight, the OD<sub>600</sub> standardized to the lowest reading and a 1:100 dilution of each strain inoculated together into BHIS broth. Samples were taken at 0, 2, 4, 6, 8, 10 and 24 h, diluted and plated onto BHIS-CC agar [BHIS supplemented with cefoxitin (8 mg/L) and cycloserine (250 mg/L)] for total viable count and onto BHIS-CC-FDX agar (BHIS-CC + 2 × MIC of fidaxomicin; 0.5 mg/L) for mutant count. cfu/mL were calculated from the colony counts after a 24 h incubation.

**Measurement of sporulation rates** We analysed spore production over a 120 h period. Sporulation rates were determined by measuring the development of spores that formed cfu after heat shock over time.<sup>2</sup>

*C. difficile* strains were grown from frozen stocks on BHIS-CC agar. Sporulation was achieved through incubation of cultures in BHIS broth in anaerobic conditions at 37°C for 5 days. Overnight cultures of *C. difficile* isolates were used to inoculate a starter culture in BHIS broth diluted 1:100, which was grown to an OD<sub>600</sub> of between 0.2 and 0.5 to ensure low levels of spores on inoculation of the main sporulation culture. The main culture was then inoculated 1:100 with the starter culture (timepoint 0).

To measure colony formation, 500 µL samples of the sporulation medium were removed (at 0, 24, 48, 72, 96 and 120 h) from the anaerobic chamber and heated at 65°C for 30 min to kill vegetative cells, but not spores. Samples were returned to the anaerobic chamber, serially diluted in phosphate buffered saline and plated onto BHIS agar supplemented with the bile salt taurocholate (0.1%, Sigma) to induce germination and enhance recovery of *C. difficile* spores. Plates were incubated for 24 h before heat-resistant cfu were enumerated. For all measurements of heat-resistant cfu, a *spo0A* mutant strain, in which the master regulator of sporulation has been inactivated, was included as a sporulation-negative control.<sup>25</sup>

**Measurement of toxin A/B production via ELISA** Strains were grown in TY broth, overnight cultures were subcultured 1:100 into fresh media and supernatants of mutants and parental strains were collected at 24, 48 and 72 h. The production of toxin A/B was quantified by a standard curve using a toxin A/B ELISA assay (Techlab TOX A/B ELISA<sup>™</sup>). The standard curve was produced using *C. difficile* toxin A and B standards (The Native Antigen Company), serially diluted 1:2 from 125 to 1.95 ng/mL.

**Measurement of cytotoxicity** *C. difficile* strains were cultured in TY broth. Overnight cultures were subcultured 1:100 into fresh media and sampled at 0, 24, 48 and 72 h. At each timepoint, OD<sub>600</sub> was measured, samples centrifuged and the supernatant filter sterilized and stored at –20°C. The supernatants were serially diluted, added to confluent monolayers of Vero (African green monkey kidney) cells and incubated for 24 h before scoring under a microscope. The toxin endpoint titre was the dilution at which the Vero cells resembled a negative control (no cell rounding).

## In vivo testing of mutant strains

### Virulence testing using a hamster infection model

*In vitro* findings were correlated with actual virulence and colonization assays *in vivo*. Infectivity was assessed in infection assays using female Golden Syrian hamsters, as described previously.<sup>19</sup> Groups of eight hamsters were pretreated with clindamycin for 7 days prior to being challenged with  $10^5$  *C. difficile* spores. The primary output was survival or prolonged survival. Hamsters were monitored for disease symptoms and general condition, and euthanized when a predetermined threshold of symptom severity and/or worsening of condition was met, according to a previously published scoring system.<sup>26</sup>

### Enumeration of caecal colonization

As a secondary assessment, the adherence properties of the mutant and parental strains were compared by enumerating the bacteria obtained from the caeca of infected hamsters. This was deemed to represent colonization. In brief, homogenized samples were centrifuged and the resulting supernatant heat-treated at 65°C prior to serial dilution and plating on cycloserine-cefoxitin fructose agar. The number of colonies was counted after 2–3 days of incubation.

## Statistical methods

All statistical analysis was carried out using GraphPad Prism. One-way or two-way ANOVA, followed by Dunnett's multiple comparison test or Sidak's multiple comparison test, were used. All *P* values reported are multiplicity adjusted.

## Results

### Generation of *C. difficile* mutant strains by allelic exchange

The desired single nucleotide changes were introduced into the *C. difficile* genome to create the CRG20291 derivative strains. In all three instances, fidaxomicin-resistant colonies were obtained and the presence of the anticipated SNP confirmed in each strain. In CRG20291-TA, the thymine at *rpoB* position 3428 was changed to adenine, substituting valine with aspartic acid (Val1143Asp). In CRG20291-TG, the thymine at *rpoB* position 3428 was replaced with guanine, substituting valine with glycine (Val1143Gly). In CRG20291-GT, the guanine at position 3427 was replaced with thymine, substituting valine with phenylalanine (Val1143Phe). Sequencing confirmed that mutants did not contain additional spontaneous genomic changes compared with the parental strain.

### In vitro testing of mutant strains

#### MICs

All constructed mutants had reduced susceptibility to fidaxomicin compared with the parental strain. CRG20291-TA had the lowest susceptibility (MIC >32 mg/L), followed by CRG20291-TG (8 mg/L) and lastly CRG20291-GT (2 mg/L), versus the parental strain (0.25 mg/L).

#### Strain phenotypic characterization

**Growth** All mutants grew differently compared with the parental strain (Figure 2), with all three reaching lower peak OD<sub>600</sub> values

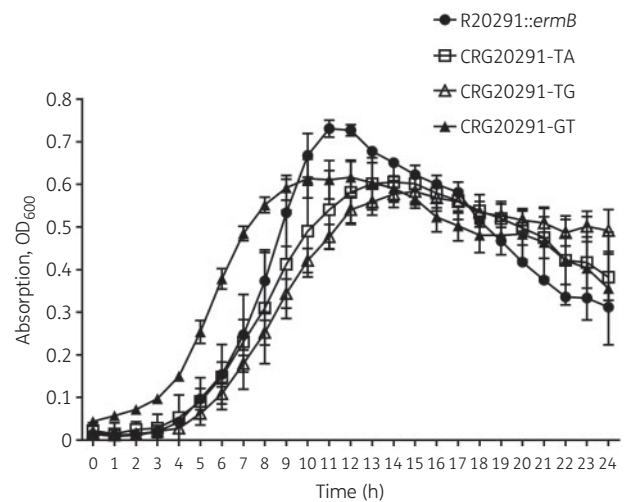
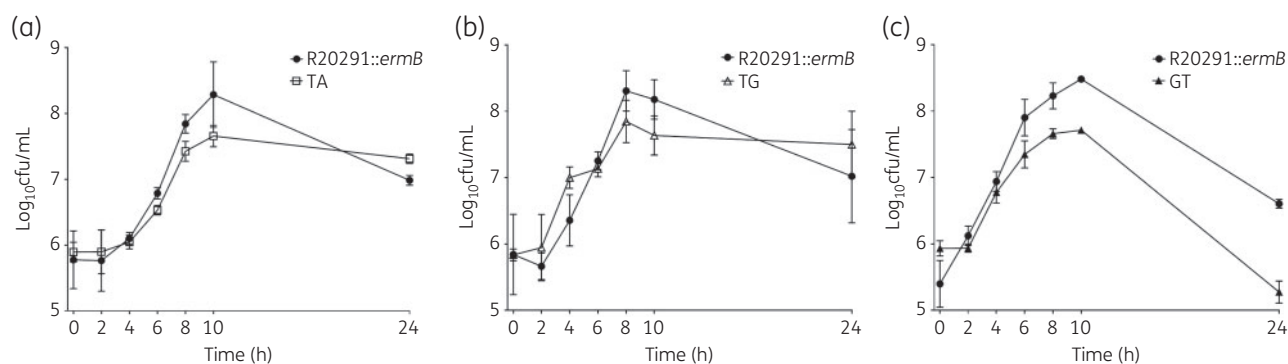

**Figure 2.** Growth curves over 24 h for mutants CRG20291-TA (open squares), CRG20291-TG (open triangles) and CRG20291-GT (filled triangles) compared with the parental strain of *C. difficile* (filled circles). Values are plotted as mean  $\pm$  SD.

than their progenitor. CRG20291-GT exhibited a shorter lag phase versus the parental and the other two mutant strains. The time to peak OD<sub>600</sub> was shorter ( $\sim$ 11 h) for the parental strain compared with  $\sim$ 14 h for both CRG20291-TA and CRG20291-TG. The generation time was similar between CRG20291-GT and the parental strain, but marginally impaired in the CRG20291-TA and CRG20291-TG mutants.

**Growth in competition** All three mutants were outcompeted by the parental strain *in vitro* (Figure 3). This was statistically significant for CRG20291-TA at the 10 h timepoint ( $P = 0.03$ ) and for CRG20291-GT from the 6 h timepoint onwards ( $P$  values from  $< 0.0001$  to  $0.0031$ ). Mutant CRG20291-TA showed a similar generation time and time-to-peak cfu count ( $\sim$ 10 h) to the parental strain, but the parental strain showed an 8% higher total viable count ( $P = 0.03$ ). Mutant CRG20291-TG exhibited similar growth, generation time and time-to-peak count (both 8 h) to the parental strain. When mutant CRG20291-GT was compared with the parental strain, the time-to-peak count was 10 h for both, but the generation time for the mutant lagged behind that of the parental strain (41 min, parental strain; 51 min, GT). Notably, the mutant declined more rapidly versus the parental strain and, again, peak viable count was 10% higher with the parental strain ( $P < 0.0001$ ). The parental strain appeared to have a competitive growth advantage over all three mutants, most notably compared with CRG20291-GT.

**Sporulation rate and capacity** The initiation of sporulation was delayed in all three mutants compared with the parental strain, where no spores could, in contrast to the WT, be detected after 24 h (Figure 4). Strain CRG20291-TA showed the longest delay, with heat-resistant cfu only becoming detectable after 72 h. In fact, the number of spores present at all timepoints tested remained significantly below that of the parental strain, even at 120 h. CRG20291-GT showed a reduced total sporulation capacity versus the parental strain at 24, 96 and 120 h, and equalled it at 48 and 72 h. Strain CRG20291-TG also formed no heat-resistant cfu at 24 h and fewer than the parental strain at 48 h, but



**Figure 3.** *In vitro* growth in competition assay for the three mutant strains (a) CRG20291-TA (open squares), (b) CRG20291-TG (open triangles) and (c) CRG20291-GT (filled triangles) compared with the parental strain of *C. difficile* (filled circles). Each mutant was grown in competition with the parental strain and fitness was evaluated over 24 h. Values are plotted as mean  $\pm$  SD.

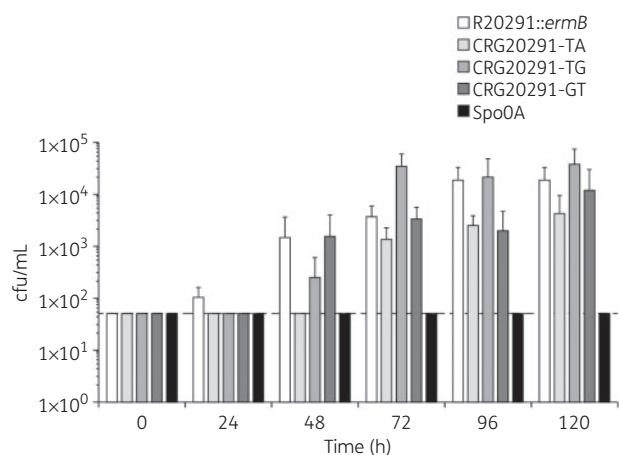
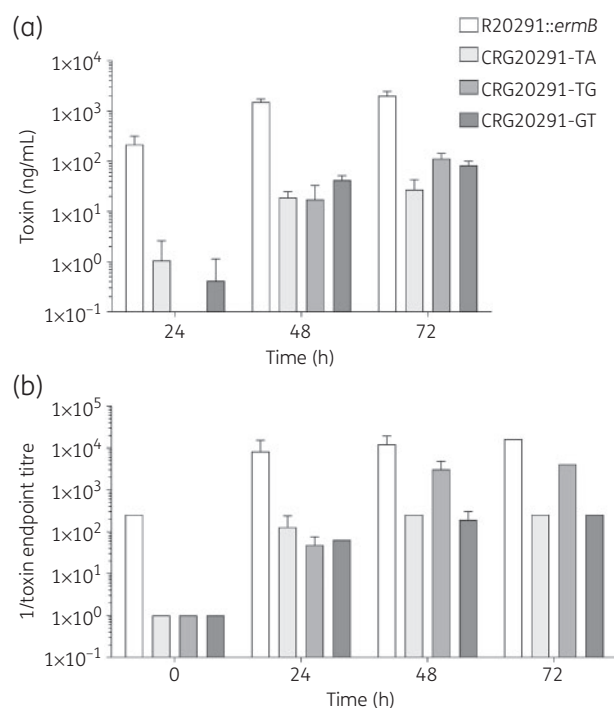

**Figure 4.** Rates of sporulation in the parental strain, mutant strains and sporulation-negative control. Values are plotted as mean  $\pm$  SD. The broken line represents the detection limit of the assay (50 cfu/mL).

produced more spores than the parental strain (albeit not statistically significant) from 72 h onwards. The majority of differences, apart from that between CRG20291-TG and the parental strain at 72 h ( $P = 0.0014$ ), were not statistically significant.

**Toxin A/B production** In all three mutants, toxin A/B production was attenuated compared with the parental strain at all time-points measured (Figure 5a). For strain CRG20291-TG, the lag in toxin A/B production was particularly evident, with no toxin detected at 24 h. At 72 h, the difference in level of toxin A/B production between mutant and parental strains was 74-fold for CRG20291-TA, 18-fold for CRG20291-TG and 24-fold for CRG20291-GT ( $P \leq 0.0001$  for all measurements).

**Cytotoxicity** All three mutants showed reduced cytotoxicity in Vero cells at all timepoints compared with the parental strain (Figure 5b). At 48 and 72 h post-incubation, the culture supernatant of strain CRG20291-TG demonstrated higher cytotoxicity than the other two mutant strains, although it was still 4-fold less cytotoxic than the parental strain's culture supernatant.

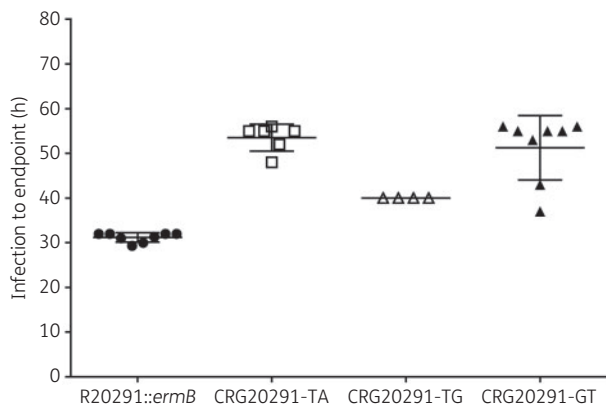

**Figure 5.** Toxin A/B production and cytotoxicity. (a) Toxin production by ELISA assay in TY broth. (b) Cytotoxicity in Vero cells. Values are plotted as mean  $\pm$  SD.

### ***In vivo* virulence and caecum colonization in the hamster infection model**

#### *Virulence and colonization*

All three mutant strains showed a statistically significant reduction in virulence compared with the parental strain in the hamster infection model ( $P$  values from 0.0001 to 0.0087; Figure 6). CRG20291-TA showed the lowest level of virulence (with a mean of 53.5 h until clinical endpoint), followed by CRG20291-GT (mean 51.25 h) and then CRG20291-TG (mean 40 h). The parental strain was the most virulent, with a mean of 31.2 h until clinical endpoint. There was no significant difference in colonization levels of hamster caecum



**Figure 6.** Time from spore infection to clinical endpoint (sign of infection) using the hamster model of infection for mutants CRG20291-TA (open squares), CRG20291-TG (open triangles) and CRG20291-GT (filled triangles) compared with the parental strain of *C. difficile* (filled circles). Values are plotted as mean  $\pm$  SD.

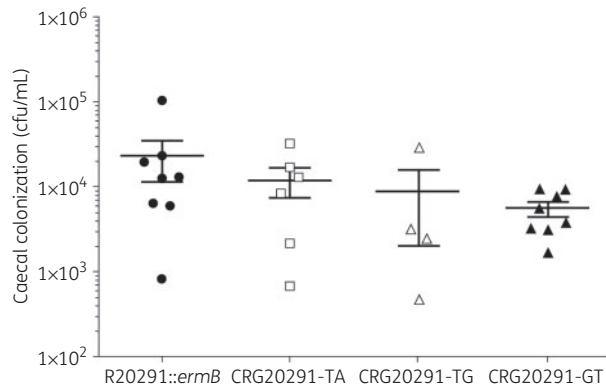

**Figure 7.** Caecum colonization in the hamster model of infection. After the endpoint, caecal colonization was evaluated, by plating on cycloserine-cefoxitin fructose agar. The mutants CRG20291-TA (open squares), CRG20291-TG (open triangles) and CRG20291-GT (filled triangles) were compared with the parental strain of *C. difficile* (filled circles). Values are plotted as mean  $\pm$  SD.

between the parental and the mutant strains (Figure 7). The mutant strains did colonize slightly less with averages of  $1.20E+04$  (CRG20291-TA),  $8.96E+03$  (CRG20291-TG) and  $5.55E+03$  (CRG20291-GT) cfu/mL compared with  $2.34E+04$  cfu/mL for the parental strain.

## Discussion

In the present study, we confirmed a link between the genotypic changes in the RNA polymerase  $\beta$  subunit *rpoB* and reduced susceptibility of *C. difficile* to fidaxomicin using directed mutagenesis in *C. difficile*. The created mutant strain CRG20291-TA had an MIC of  $>32$  mg/L, which is by far the highest resistance exhibited by the three strains.

A random fidaxomicin mutant with the equivalent TA amino-acid substitution that was previously isolated in the laboratory was reported to have an MIC of  $>64$  mg/L.<sup>15</sup> The single clinical isolate with reduced fidaxomicin susceptibility that has been reported has

an MIC of 16 mg/L. The deliberately created mutant strain, CRG20291-TG, generated in the current study, has the same amino-acid changes as the clinical isolate and an MIC of 8 mg/L. Finally, strain CRG20291-GT, created here, has an MIC of 2 mg/L, which is the same as a previously isolated random GT mutant. These data show that the fidaxomicin susceptibilities of the mutant strains generated in the present study are broadly in line with the previously isolated random mutants of Seddon et al.<sup>15</sup> An in-depth phenotypic characterization comparing parental strain and mutants revealed changes in virulence-associated traits, such as competitive growth, sporulation and toxin production. First, they showed altered growth over a 24 h period *in vitro*, and less competitive growth fitness versus the parental strain. Sporulation characteristics, an important feature of *C. difficile* that plays a significant role in the transmission and recurrence of CDI, particularly in a hospital setting, were also marginally affected in the mutant strains.<sup>2</sup> Toxin production and cytotoxicity were also reduced in the mutants compared with the parental strain.

Furthermore, we found reduced virulence of the *rpoB* mutants compared with the parental strain in the hamster infection model. The virulence of strains CRG20291-TA and GT were most greatly reduced (53.5 and 51.25 h, respectively, to the clinical endpoint compared with 31.2 h for the parental strain). Interestingly, CRG20291-GT was also most impaired in the competition assay and, albeit not statistically significant, seemed to exhibit slightly reduced colonization. The *in vivo* assessment of virulence might suggest that *C. difficile* strains with reduced susceptibility to fidaxomicin may be less able to cause disease and would, as a consequence, be less likely to persist in a clinical setting. It would be interesting to investigate further whether these mutants produce less toxin *in vivo*, which could play a role in their ability to cause disease. Additionally, it would be illuminating to investigate the sporulation ability of these mutants, given the crucial role of spores in persistence and transmission. So far, only one resistant clinical isolate has been characterized,<sup>27</sup> which may indicate that such strains are not particularly prevalent or widespread in the clinical setting. Nevertheless, further investigations and evaluation are required.

Despite the high faecal concentrations of fidaxomicin achieved during therapy for CDI ( $>1$  mg/g),<sup>9,28</sup> the clinical relevance of spontaneous *rpoB* mutants is unknown. In the case of rifamycin resistance, studies have shown that no fitness cost is associated with the mutation. Equally, it has been shown that these mutations do persist *in vivo*, in the clinical setting.<sup>29</sup> In the case of fidaxomicin during all of these trials, there was only one report of a strain with reduced susceptibility, which was isolated from a relapse patient during a clinical trial.<sup>27</sup>

Interestingly, *rpoB* gene mutations that are clinically relevant have been identified in other bacteria. For example, in *Mycobacterium tuberculosis*, such mutations are thought to be associated with varying fitness costs and some mutations have been associated with altered cell wall permeability. These *M. tuberculosis* mutations are a clinical concern and can even accumulate in the latent stage of the disease.<sup>30,31</sup> In *Neisseria meningitidis*, different mutations within *rpoB* have been associated with a range of fitness costs, and it has been suggested that the impact on virulence is such that they are only very rarely seen in the clinical setting.<sup>32</sup> Conversely, a study of *rpoB* mutations conferring reduced susceptibility of *C. difficile* to rifamycin<sup>29</sup> found that

the majority of mutations generated in that study lacked *in vitro* fitness costs. Among these was the Arg505Lys substitution, which was as virulent as the WT, providing a possible explanation for its dominance among rifamycin-resistant clinical isolates.

Our findings suggest that the specific *rpoB* mutations isolated and analysed in this study that were responsible for fidaxomicin resistance also impose a fitness cost. It might then be conceivable that fidaxomicin is less likely to cause a rapid spread of resistant isolates compared with other antibiotics that inhibit RNA polymerase, such as the rifamycins. This suggestion is supported by the paucity (just one) of fidaxomicin-resistant strains isolated from clinical settings to date.<sup>27</sup>

Our study had a number of limitations, the primary one being the small number of replicates in the samples. The use of OD (turbidity) as a measurement of viable bacterial cell count is also a limitation, as OD has been shown not to be truly congruent with viable count,<sup>33</sup> although our competition experiments were based on viable counts. However, we do not perceive the limitations to be considerable, as we assessed relative differences between the strains, which would be disposed to the same limitations. Further work is required to explore the frequency of these *rpoB* mutations in clinical situations.

In conclusion, in the present study, *rpoB* mutations in *C. difficile* strains were recreated using directed mutagenesis and shown to confer reduced susceptibility to fidaxomicin. The mutants were additionally shown to exhibit reduced competitive fitness *in vitro* and to be less virulent *in vivo* compared with the parental strain. The changes in phenotype that result from these alterations in the primary sequence of *rpoB* may have consequences for the mutant cell lines carrying these amino-acid substitutions. The reduced fitness of such mutants might explain, at least in part, why so few cases of fidaxomicin resistance have been reported in the literature so far.

## Acknowledgements

We would like to thank Tina Morley and Rhian Harper Owen from iS LifeScience for their editorial support, funded by Astellas Pharma, Inc., in the preparation of the article. We would also like to thank Sharla McTavish for assistance with strain characterization.

## Funding

This work was supported by Astellas Pharma, Inc. This funding covered the initiation of the study, conduct of the research and editorial support for the manuscript.

## Transparency declarations

S. A. K. and N. P. M. have received grants from Summit plc. C. M. L. was a full-time salaried employee of Astellas Pharma Europe Ltd at the time of this study. He also has an international patent application, WO2015EP00965, in relation to a treatment regimen for fidaxomicin. All other authors: none to declare.

This study was initiated by Astellas Pharma, Inc. Under the direction of the authors, Tina Morley from iS LifeScience drafted the initial version of the manuscript and Rhian Harper Owen provided editorial support throughout its development.

## Author contributions

All authors met ICMJE criteria for authorship, were involved in revising the article critically for important intellectual content and approved the final version of the manuscript for submission. All others who contributed to this document, but who did not meet authorship criteria, are acknowledged.

## References

- Hutton ML, Mackin KE, Chakravorty A *et al.* Small animal models for the study of *Clostridium difficile* disease pathogenesis. *FEMS Microbiol Lett* 2014; **352**: 140–9.
- Burns DA, Heeg D, Cartman ST *et al.* Reconsidering the sporulation characteristics of hypervirulent *Clostridium difficile* BI/NAP1/027. *PLoS One* 2011; **6**: e24894.
- US Department of Health and Human Services, CDC. *Antibiotic Resistance Threats in the United States, 2013*. <http://www.cdc.gov/drugresistance/pdf/ar-threats-2013-508.pdf>.
- Cocanour CS. Best strategies in recurrent or persistent *Clostridium difficile* infection. *Surg Infect (Larchmt)* 2011; **12**: 235–9.
- Rafii F, Sutherland JB, Cerniglia CE. Effects of treatment with antimicrobial agents on the human colonic microflora. *Ther Clin Risk Manag* 2008; **4**: 1343–57.
- Cornely OA, Miller MA, Louie TJ *et al.* Treatment of first recurrence of *Clostridium difficile* infection: fidaxomicin versus vancomycin. *Clin Infect Dis* 2012; **55** Suppl 2: S154–61.
- Lynch T, Chong P, Zhang J *et al.* Characterization of a stable, metronidazole-resistant *Clostridium difficile* clinical isolate. *PLoS One* 2013; **8**: e53757.
- Spigaglia P. Recent advances in the understanding of antibiotic resistance in *Clostridium difficile* infection. *Ther Adv Infect Dis* 2016; **3**: 23–42.
- Zhanell GG, Walkty AJ, Karlowsky JA. Fidaxomicin: a novel agent for the treatment of *Clostridium difficile* infection. *Can J Infect Dis Med Microbiol* 2015; **26**: 305–12.
- Artsimovitch I, Seddon J, Sears P. Fidaxomicin is an inhibitor of the initiation of bacterial RNA synthesis. *Clin Infect Dis* 2012; **55** Suppl 2: S127–31.
- Louie TJ, Emery J, Krulicki W *et al.* OPT-80 eliminates *Clostridium difficile* and is sparing of *Bacteroides* species during treatment of *C. difficile* infection. *Antimicrob Agents Chemother* 2009; **53**: 261–3.
- Goldstein JC, Citron DM, Sears P *et al.* Comparative susceptibilities to fidaxomicin (OPT-80) of isolates collected at baseline, recurrence, and failure from patients in two phase III trials of fidaxomicin against *Clostridium difficile* infection. *Antimicrob Agents Chemother* 2011; **55**: 5194–9.
- Citron DM, Babakhani F, Goldstein EJ *et al.* Typing and susceptibility of bacterial isolates from the fidaxomicin (OPT-80) phase II study for *Clostridium difficile* infection. *Anaerobe* 2009; **15**: 234–6.
- Drekonja DM, Butler M, MacDonald R *et al.* Comparative effectiveness of *Clostridium difficile* treatments: a systematic review. *Ann Intern Med* 2011; **155**: 839–47.
- Seddon J, Babakhani F, Gomez A *et al.* RNA polymerase target modification in *Clostridium difficile* with reduced susceptibility to fidaxomicin. In: *Abstracts of the Fifty-first Interscience Conference on Antimicrobial Agents and Chemotherapy, Chicago, IL, USA, 2011*. Abstract C1-1274. American Society for Microbiology, Washington, DC, USA.
- Leeds JA, Sachdeva M, Mullin S *et al.* *In vitro* selection, via serial passage, of *Clostridium difficile* mutants with reduced susceptibility to fidaxomicin or vancomycin. *J Antimicrob Chemother* 2014; **69**: 41–4.
- Grove A. MarR family transcription factors. *Curr Biol* 2013; **23**: R142–3.
- Kuehne SA, Coltery MM, Kelly ML *et al.* Importance of toxin A, toxin B, and CDT in virulence of an epidemic *Clostridium difficile* strain. *J Infect Dis* 2014; **209**: 83–6.



- 19** Kelly ML, Ng YK, Cartman ST et al. Improving the reproducibility of the NAP1/B1/027 epidemic strain R20291 in the hamster model of infection. *Anaerobe* 2016; **39**: 51–3.
- 20** Williams DR, Young DI, Young M. Conjugative plasmid transfer from *Escherichia coli* to *Clostridium acetobutylicum*. *J Gen Microbiol* 1990; **136**: 819–26.
- 21** Ng YK, Ehsaan M, Philip S et al. Expanding the repertoire of gene tools for precise manipulation of the *Clostridium difficile* genome: allelic exchange using *pyrE* alleles. *PLoS One* 2013; **8**: e56051.
- 22** Larson HE, Borriello SP. Quantitative study of antibiotic-induced susceptibility to *Clostridium difficile* enterocolitis in hamsters. *Antimicrob Agents Chemother* 1990; **34**: 1348–53.
- 23** Sambol SP, Tang JK, Merrigan MM et al. Infection of hamsters with epidemiologically important strains of *Clostridium difficile*. *J Infect Dis* 2001; **183**: 1760–6.
- 24** Clinical and Laboratory Standards Institute. *Methods for Antimicrobial Susceptibility Testing of Anaerobic Bacteria—Eighth Edition: Approved Standard M11-A8*. CLSI, Wayne, PA, USA, 2012.
- 25** Heap JT, Kuehne SA, Ehsaan M et al. The Clostron: mutagenesis in *Clostridium* refined and streamlined. *J Microbiol Methods* 2010; **80**: 49–55.
- 26** Kuehne SA, Cartman ST, Heap JT et al. The role of toxin A and toxin B in *Clostridium difficile* infection. *Nature* 2010; **467**: 711–4.
- 27** Goldstein EJ, Babakhani F, Citron DM. Antimicrobial activities of fidaxomicin. *Clin Infect Dis* 2012; **55** Suppl 2: S143–8.
- 28** Sears P, Crook DW, Louie TJ et al. Fidaxomicin attains high fecal concentrations with minimal plasma concentrations following oral administration in patients with *Clostridium difficile* infection. *Clin Infect Dis* 2012; **55** Suppl 2: S116–20.
- 29** Dang UT, Zamora I, Hevener KE et al. Rifamycin resistance in *Clostridium difficile* is generally associated with a low fitness burden. *Antimicrob Agents Chemother* 2016; **60**: 5604–7.
- 30** Lahiri N, Shah RR, Layre E et al. Rifampin resistance mutations are associated with broad chemical remodeling of *Mycobacterium tuberculosis*. *J Biol Chem* 2016; **291**: 14248–56.
- 31** Ford CB, Lin PL, Chase MR et al. Use of whole genome sequencing to estimate the mutation rate of *Mycobacterium tuberculosis* during latent infection. *Nat Genet* 2011; **43**: 482–6.
- 32** Colicchio R, Pagliuca C, Pastore G et al. Fitness cost of rifampin resistance in *Neisseria meningitidis*: in vitro study of mechanisms associated with RpoB H553Y mutation. *Antimicrob Agents Chemother* 2015; **59**: 7637–49.
- 33** Augustin JC, Rosso L, Carlier V. Estimation of temperature dependent growth rate and lag time of *Listeria monocytogenes* by optical density measurements. *J Microbiol Methods* 1999; **38**: 137–46.